

EDGE™ 1.2

BY VOLFONI®

User Manual

3D CINEMA IR SYNCHRONIZER KIT

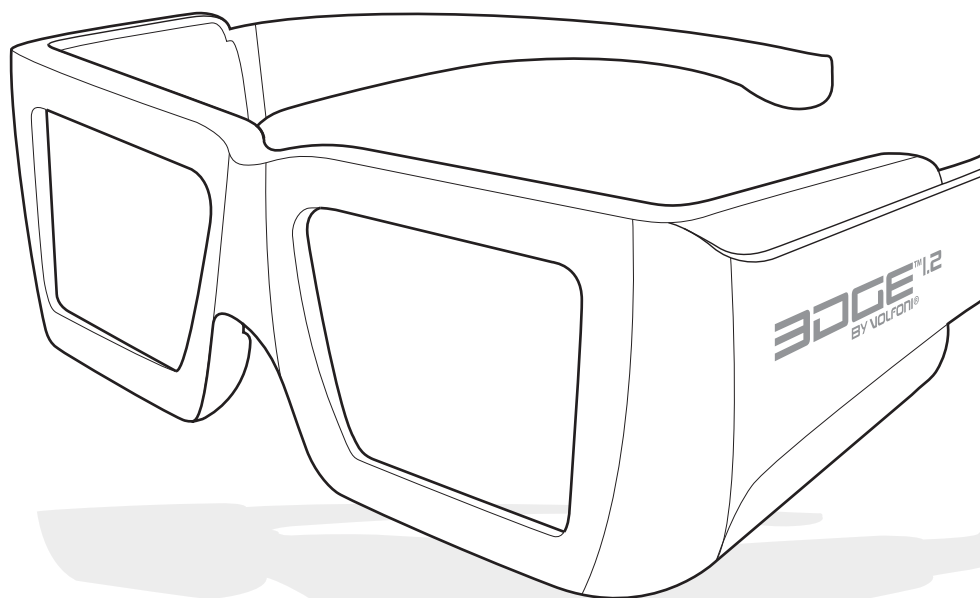

MUV110064-V1R2 EDGE™ 1.2 User Manual

VOLFONI 
CREATIVE 3D TECHNOLOGY



I. 3D KIT PRESENTATION

1. General presentation
2. 3D kit composition

II. PRODUCT DESCRIPTION

1. Glasses
2. IR emitter
3. Tester
4. Synchronizer

III. 3D KIT FASTENING

IV. CONNECTION & SYNCHRONIZATION



1. GENERAL PRESENTATION

As a result of Volfoni's long experience in managing the world's largest stock of active 3D glasses, EDGE™ 1.2 benefits from the latest ergonomic and technical innovations. EDGE™'s comfort and easy use is unmatched.

The power of EDGE™ 1.2

- Exceptional image quality without ghosting, wherever you sit.
- The brightest light level on the market.
- The 3D kit (infra-red emitter) allows easy integration in less than 30 min with existing digital theaters using a standard screen.

EDGE™ 1.2 offers all the benefits of active glasses

A full EDGE™ system includes

- EDGE™ 3D glasses
- 3D kit (emitter system)

Accessories are available

- Antibacterial cleaning wipes
- Battery replacement tool
- Adaptable "arms" to fit any head size

In option: Anti-theft panels & anti-theft tagged glasses

I. 3D KIT PRESENTATION

2. 3D KIT COMPOSITION

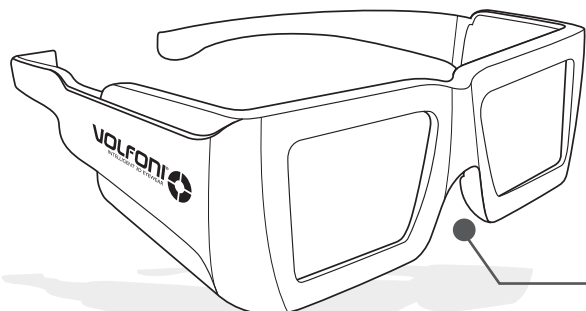

EDGE™ 1.2 GLASSES

+ battery tool
+ removable arms

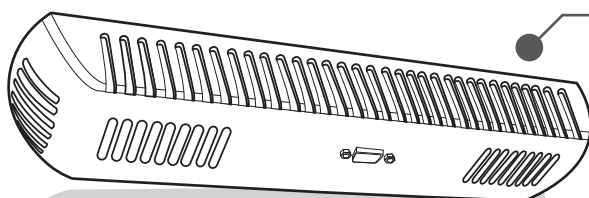

IR EMITTER

+ fixing
+ wire

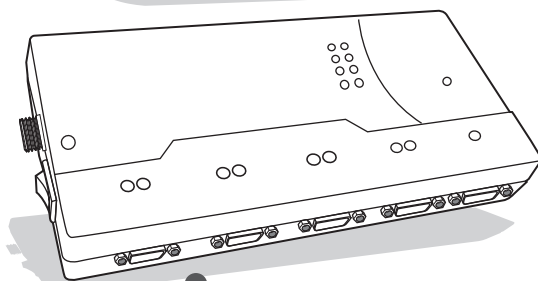

SYNCHRONIZER

+ power cord
+ GPIO synchronizer cable

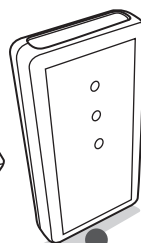

TESTER

Operating Temperature: 0°C -40°C (32F-104F)
Storage Temperature: -10°C -50°C (14F-122F)

1. GLASSES

The VOLFONI Active 3D Glasses use fast-response liquid crystal lenses to create the best image quality. It is the brightest and most cost-saving 3D solution currently on the market.

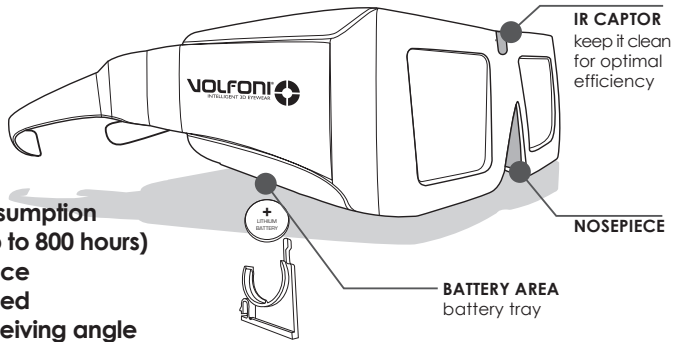

- Low power consumption (battery lasts up to 800 hours)
- Rubber nosepiece
- Stylish and rugged
- Unbeatable receiving angle
- Automatic ON/OFF
- Standard size, replaceable battery
- Adaptively synchronizing
- Optimal circuit layout
- CE certified

Note: Please, make sure that there is no obstacle in front of the IR captor during 3D projection.

USE AND SETUP

The 3D glasses do not need any setup to start. It is nevertheless necessary to check all settings and connections of the 3D digital cinema system before projection. When started, the lenses need 2 seconds to warm up and turn into working mode. Then the lenses appear clear. When the 3D projection is finished or turned into 2D, the lenses will remain clear for about 5 minutes. They will go directly into operation mode again when a new signal is received.

ARMS

The glasses come with L size arms, and M & S size arms are available upon request. For easy removal, just push in the new arms until you hear the "click".

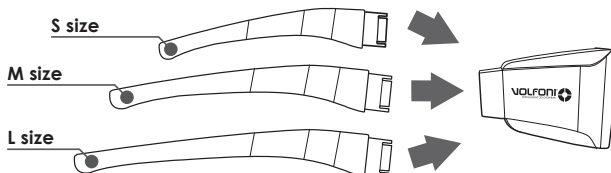

II. PRODUCT DESCRIPTION

BATTERY REPLACEMENT

- To open the battery encasement on the right arm of the glasses:
- Use an instrument such as the Volfoni's battery tool, a paper clip or a prong.
 - Put the glasses on a desk/table as it will be more convenient and easy
 - Find the small hole on the right arm of the glasses, where the arm connects with the battery encasement. **1 2**
 - Put the prong inside and when you hear a "click," you can pop open the battery encasement **3**

make sure you install the battery in the right position

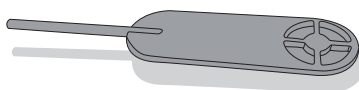
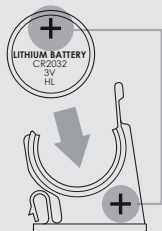

BATTERY TOOL
to unlock the battery

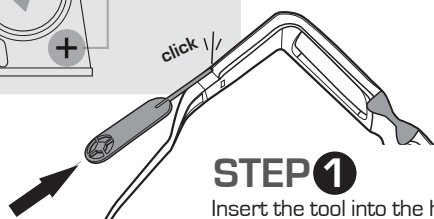

STEP 1

Insert the tool into the hole in the under right side of glasses. You feel some resistance, then push and feel/hear the unlocking "click".

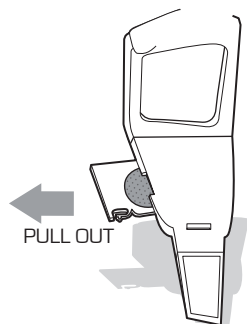

STEP 2

Pull towards you with your nail to remove the battery tray

STEP 3

Reinsert the battery and push to hear the "click" to lock it.

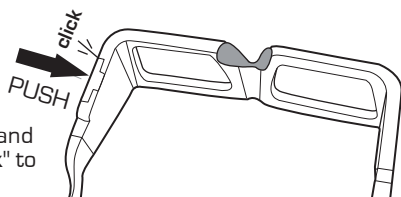

Note: When the battery has less than three hours remaining, the lenses will flash once a second to indicate that you must change the battery. It is recommended to check the battery life before distributing to viewers.

Thank you for using our STANDARD ACTIVE 3D DIGITAL CINEMA SYSTEM. Before starting, please check if the following parts are included in the package.

2. IR EMITTER

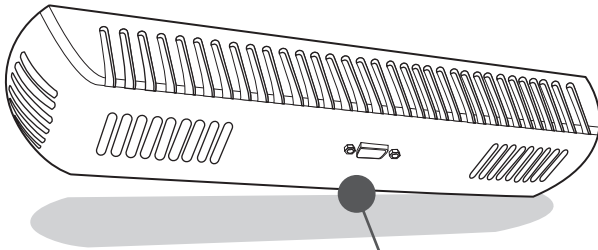

Long Range IR Emitter

Long Range IR Emitter VAIK-0100 is a compact and powerful unit. The emitter, with many built-in infrared LEDs, allows coverage all types of theater rooms, regardless of the number of seats. 4 emitters can be linked up. Thanks to its lightweight design, VAIK-0100 enhances the heat dissipation (LED life protection). It is provided with a universal mounting head for security, and is easy to install. It is simple to target the screen with the emitter laser pointer.

Please do not put the emitter in front of the audience.

Emitter at a Glance

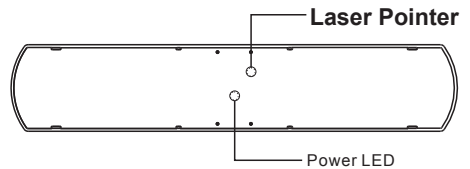
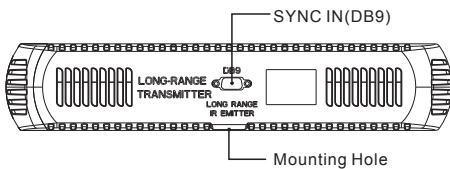

II. PRODUCT DESCRIPTION

Basic Specification

IR Wavelength: 940 nm

Power Consumption: 10W in active status

Laser: Max Output: 0.5mW, Wavelength: 650 nm± 10

Dimension: 361 mm x 70 mm x 44 mm

WARNING: The laser pointer of this emitter emits Class IIIA laser. Please DO NOT stare into beam or view directly with optical instruments.

3. TESTER

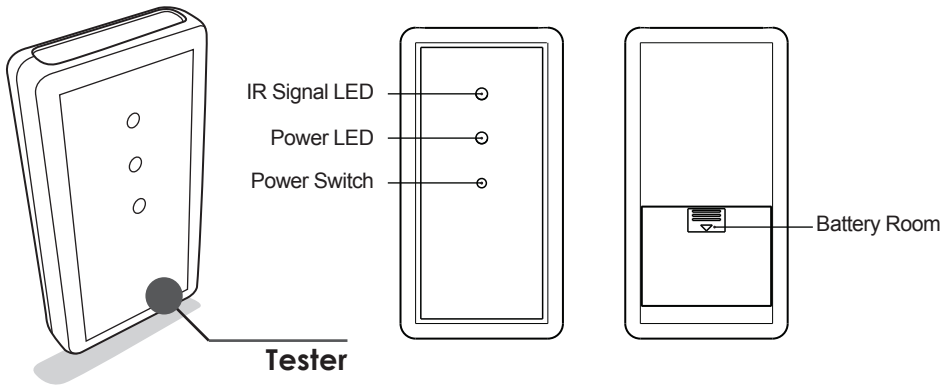

Active 3D Glasses VAIK-0300 is a handy unit to be carried by a cinema technician to check performance of 3D glasses. Turn on the power, then the tester emits low rate IR signal to activate 3D glasses. Working 3D glasses will then show a flickering.

Additional Specification

Power supply: 3xAA batteries

4. SYNCHRONIZER

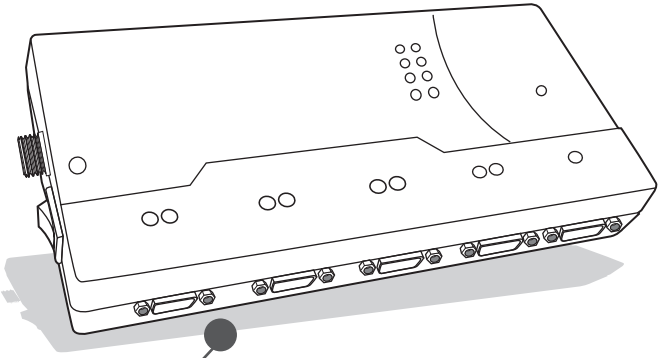

Power Module

Multi-function Distribution Module

The multi-function Distribution Module is a unit specially designed for mid size and large digital 3D cinemas. This unit is plugged into the digital projector and receives frame synchronizing signal via GPIO (DB-37). It extends to four DB-9 emitter outputs. It also supports the extension of the Distribution Module thanks to a DIN-3 cable, that simplifies cinema wiring. Each port is equipped with an error diagnosis indicating LED.

II. PRODUCT DESCRIPTION

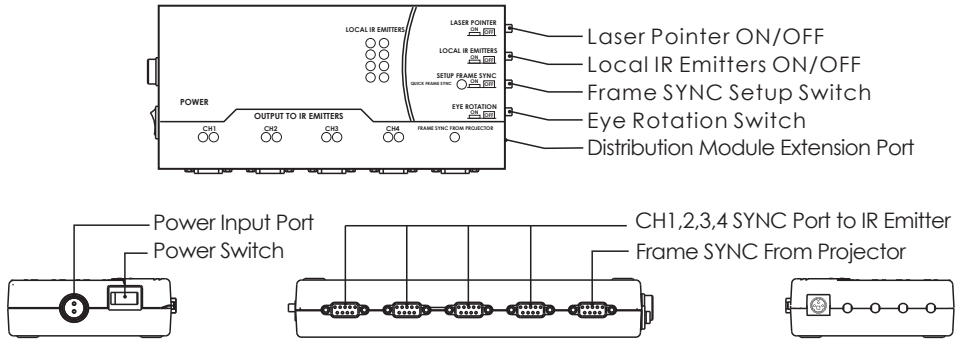

Switch Function Description

LASER POINTER: ON/OFF switch for each emitter laser.

LOCAL IR EMITTERS: ON/OFF switch for local IR emitters. Local IR emitters are very convenient to check 3D effect on screen.

SETUP FRAME SYNC: Switch on to detect frame synchronizing range.

EYE INVERSION: Switch left/right eye image.

POWER: Turn ON/OFF the power of the Distribution Module.

Indication LED status definition

POWER: LED lights come on when power is on, otherwise lights are out.

CH1: Red LED lights come on when channel 1 IR emitter is detected, Green LED lights come on if the IR emitter is activated, otherwise lights are out.

CH2: Red LED lights come on when channel 2 IR emitter is detected, Green LED lights come on if the IR emitter is activated, otherwise lights are out.

CH3: Red LED lights come on when channel 3 IR emitter is detected, Green LED lights come on if the IR emitter is activated, otherwise lights are out.

CH4: Red LED lights come on when channel 4 IR emitter is detected, Green LED lights come on if the IR emitter is activated, otherwise lights are out.

SETUP FRAME SYNC: LED always light when input frame is synchronized between 130Hz to 150Hz, otherwise LED flickers.

FRAME SYNC FROM PROJECTOR: LED light on when frame synchronizing signal is detected from projector.

Basic Specification

Power Input: 24VDC, 3A

Default Sync In: PIN9 (+) and PIN28 (-) of GPIO(DB-37)

Dimension: 106 mm x 36 mm x 23 mm

WALL FASTENER

Before installing the emitter in the front of the screen, make sure you have all the needed tools and the instruction manual. This wall fixing part is provided with all the screws and wall anchors you might need. Follow the instructions to fasten this kit.

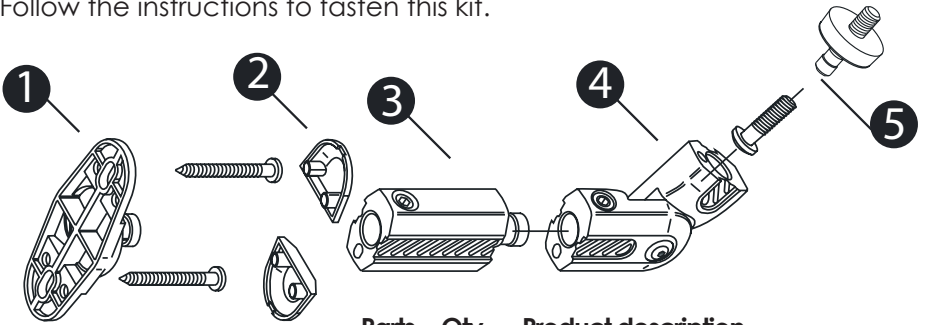

Parts	Qty	Product description
1	2	Mounting plate
2	2	Screw covers
3	1	Extension
4	1	Adjusting Knuckle
5	1	Emitter plate

WALL TYPES & HOLES SIZES

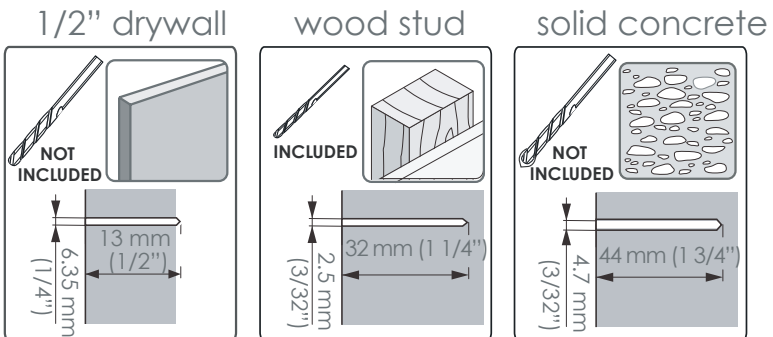

III. 3D KIT FASTENING

INSTALLATION

STEP 1

use the wall base to mark each hole to drill with a pencil.

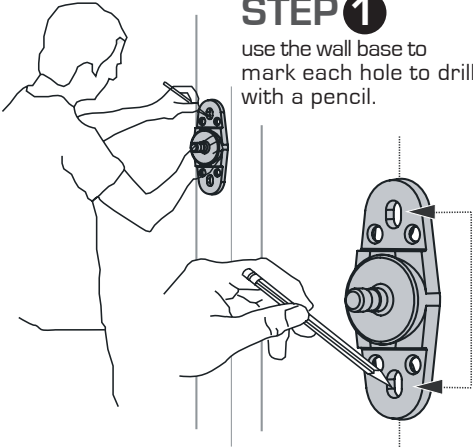

STEP 2

drill the holes with the given bit (for wood surface only)

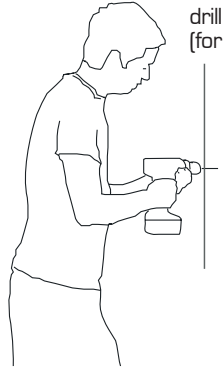

STEP 3

Insert wall anchors

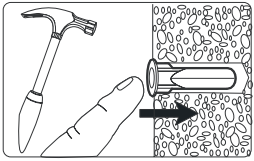

(For solid concrete and drywall only)

STEP 4

tightly screw the base to the wall

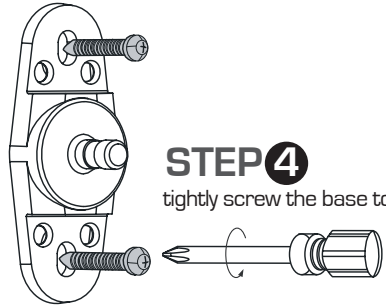

STEP 5

assemble the arm to the base and then screw the emitter on it

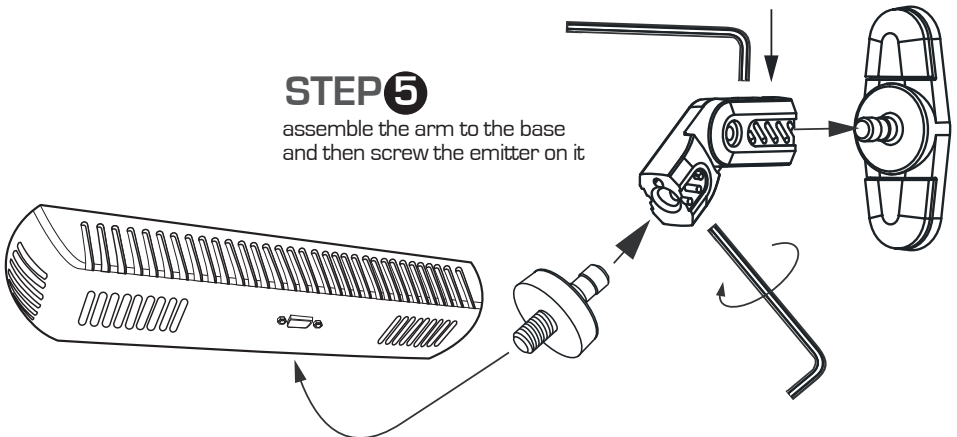

IV

Digital Projector

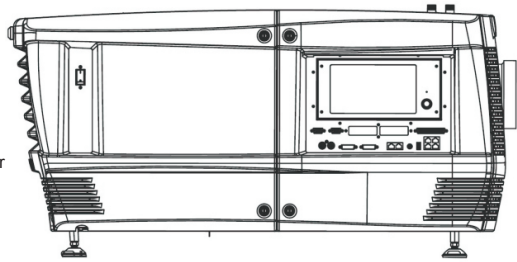

GPI/O(DB37-F) GPI/O Extension (DB37-M)

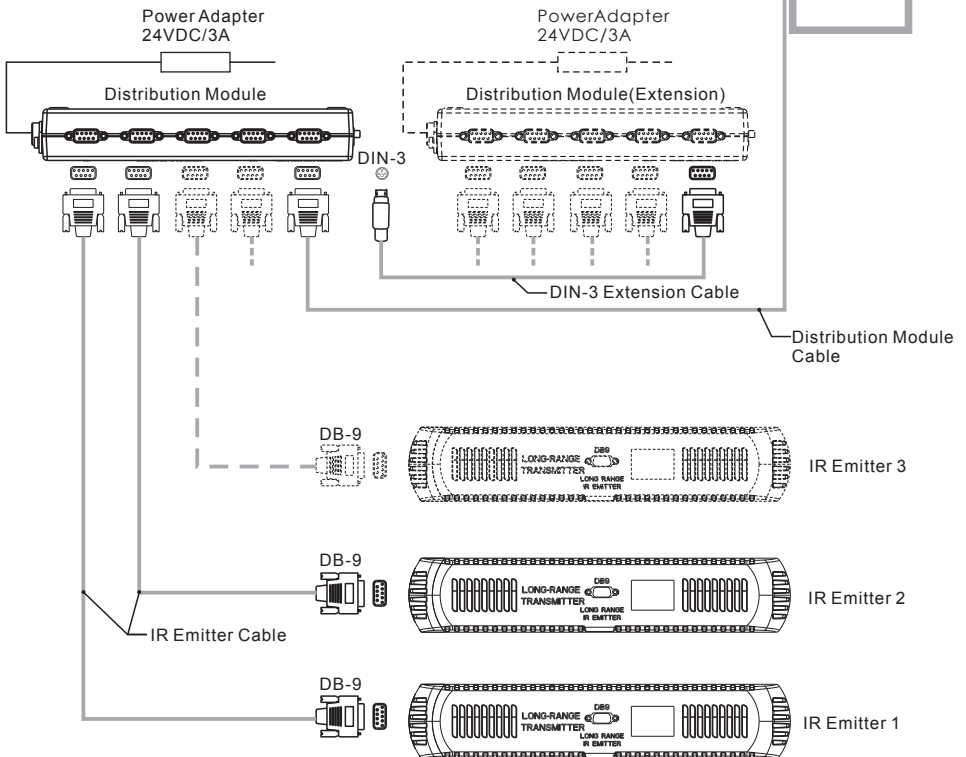
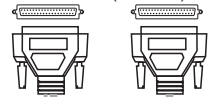

IV. CONNECTION & SYNCHRONIZATION

Please refer to the following technical board for the digital projector. These parameters are for information purpose only. They may be adapted if necessary.

TECHNICAL SPECIFICATIONS

Fall time	500µs
Rise time	1.5 ms
Contrast	> 200 (no ghosting)
Transmission in the clear state	33%
Chromaticity <i>Standard parameters</i>	Color correction not mandatory
EDGE™1.2	
Double flash (4.2)	Darktime: 500 Delay: -320
Triple flash (6.2)	Darktime: 800 Delay: -320
Weight	56 grs (less than 2 ounces)
Battery	Disposable
Autonomy	800 hrs

Warning: Depending on your equipment and the room configuration, you may have to adjust these parameters. We recommend that you confine the setup of 3D parameters and color adjustments directly to integrators.

For further information please visit our website www.volfoni.com, or send us an email to support@volfoni.com.

VOLFONI SAS

29, Rue JJ Rousseau
75001 Paris
France

VOLFONI GmbH

Erzgießereistraße 38
80335 München
Germany

VOLFONI Ltd

21, Tower one
Lippo center 89,
Queensway
Hong-Kong

VOLFONI Inc

3450, Cahuenga Bd West.
UNIT 504
Los Angeles, CA, 90068
USA

VOLFONI Ltd.

90 Long Acre
Covent Garden
London
WC2E 9RZ
UK

VOLFONI Iberia

Ronda Guglielmo Marconi, 4
46980 Paterna (Valencia)
Spain

support@volfoni.com
contact@volfoni.com

www.volfoni.com