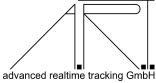

System user manual

SMARTTRACK & DTrack®

Trademarks

The following overview shows the registered trademarks of A.R.T. GmbH (Advanced Realtime Tracking GmbH):

trademarks	illustrated as	in Germany	in the EU	in the USA
A.R.T.[®]	<i>ART</i>	×	×	×
ARTtrack[®]	<i>ARTTRACK</i>	×	×	×
DTrack[®]	<i>DTrack2</i>	×		
smARTtrack[®]	<i>SMARTTRACK</i>	×	×	×
		×	×	×

Microsoft[®] and Windows[®] are trademarks registered in the United States and other countries by the Microsoft Corporation.

The company names and product names written in this manual are trademarks or registered trademarks of the respective companies.

Warranty regarding further use of the open source software

A.R.T. GmbH provides no warranty for the open source software programs contained in this product, if such programs are used in any manner other than the program execution intended by A.R.T. GmbH. The licenses define the warranty, if any, from the authors or licensors of the open source software.

A.R.T. GmbH specifically disclaims any warranties for defects caused by altering any open source software program or the product's configuration. You have no warranty claims against A.R.T. GmbH in the event that the open source software infringes the intellectual property rights of a third party. Technical support, if any, will only be provided for unmodified software. The full license text can be obtained from A.R.T. GmbH directly.

Disclaimer

In no event shall A.R.T. GmbH be liable for any incidental, indirect, or consequential damages whatsoever (including, without limitation, damages for loss of business profits, business interruption, loss of business information, or any other pecuniary loss) arising out of the use of or inability to use the software or hardware.

©1999 - 2018 by A.R.T. GmbH

ART

Advanced Realtime Tracking

Am Öferl 6

D-82362 Weilheim i. OB

Germany

 +49 (0)881-92530-00

 +49 (0)881-92530-01

 <http://www.ar-tracking.de>

What's new in version v2.14?

Following, a short overview of the main new features in *DTrack2* version v2.14:

- Integration of optical-inertial hybrid tracking (sensor fusion)
- Minor features (e.g. display IP address using DHCP, display ATC's CPU temperature)

What's new in version v2.13?

Following, a short overview of the main new features in *DTrack2* version v2.13:

- Improved stability of ethernet connection to LAN
- Enhanced usability of update procedure
- Detailed export functionality of system-configuration and event-log for tech support

What's new in version v2.12?

Following, a short overview of the main new features in *DTrack2* version v2.12:

- Integration of 'COOTrans', our co-ordinate adjustment utility. This means that the room adjustment can now be used to transform the tracking coordinate system into the coordinate system of specific 3rd party objects, provided that the reference points are known and can be measured (license-based)
- Support of bodies with up to 30 markers each
- Support of bodies with visibility restrictions including display of emission cones within 'Body Adjustment'
- Additional information dialog regarding cylindrical markers within 'Body Calibration Result Dialog'
- New function to remove unused markers from a rigid body within 'Body Adjustment'
- Radio channel settings are saved persistently when choosing a specific channel number

What's new in version v2.11?

Following, a short overview of the main new features in *DTrack2* version v2.11:

- No major changes

What's new in version v2.10?

Following, a short overview of the main new features in *DTrack2* version v2.10:

- **SMARTTRACK** now supports:
- calibration and measurement using a measurement tool&reference,
- calibration of more than four targets (license upgrade required)
- export and import of configurations (chapter 7.4.2 on page 87)
- new license model

Contents

Terms and definitions	11
1 Safety	12
1.1 Symbols and their meaning	12
1.2 Safety warnings	12
2 Introduction	15
3 Markers and targets (rigid bodies)	18
3.1 Passive markers	18
3.2 Active markers	19
3.3 Standard targets	22
4 System setup	26
4.1 Installation of the <i>SMARTTRACK</i>	26
4.1.1 Ports & Plugs on the <i>SMARTTRACK</i>	26
4.1.2 External synchronization	27
4.1.3 Mounting	28
4.1.4 Camera orientation	29
4.1.5 Localizing and removing of disturbing reflections	30
4.1.6 Room Calibration overview	31
4.2 The integrated controller inside the <i>SMARTTRACK</i>	33
4.2.1 Connection to local network LAN	34
5 Interaction devices	36
5.1 Flystick2	36
5.1.1 Control elements	36
5.1.2 Battery pack	38
5.1.3 Radio module	40
5.2 Flystick3	40
5.2.1 Control elements	41
5.2.2 Battery pack	42
5.2.3 Radio module	44
5.2.4 Wireless synchronization (active Flystick3 discontinued)	44
5.3 Flystick Installation	45
5.3.1 Radio Transceiver	45
5.3.2 Flystick Configuration	45
5.3.2.1 Flystick Calibration	46
5.3.2.2 Flystick Output settings	47

5.4	Measurement Tool	47
5.4.1	Measurement Tool Configuration	48
5.4.1.1	Measurement Tool Calibration	50
5.4.1.2	Measurement Tool Output settings	51
6	Hybrid tracking	52
6.1	Wireless hybrid targets	52
6.1.1	Connecting the wireless transceiver	52
6.1.2	Connecting the wireless inertial sensors	54
6.1.2.1	Adding wireless inertial sensors	54
6.1.3	Calibration of custom wireless hybrid targets	57
6.2	Wired hybrid targets	57
6.2.1	Connecting the wired inertial sensor	58
6.2.1.1	Adding wired inertial sensor	58
6.2.2	Assigning the wired inertial sensor	60
6.2.3	Hybrid Body Calibration	61
6.2.4	Inertial Sensor Calibration	63
6.2.4.1	Warm-up of inertial sensors	65
6.2.5	Selecting the pulse generating source	65
7	<i>DTrack2</i> frontend software	67
7.1	Getting started	67
7.1.1	Installation guide (Windows)	67
7.1.2	Installation guide (Linux)	69
7.1.3	Software update	69
7.1.4	Start <i>DTrack2</i> frontend software	69
7.1.5	<i>DTrack2</i> command line parameters	69
7.2	Connecting to the SMARTTRACK	70
7.2.1	Other Controller (1st run after installation)	71
7.2.2	Setting a static IP address inside <i>DTrack2</i>	71
7.2.3	Wake On LAN	72
7.2.4	Configuring your controller without the <i>DTrack2</i> frontend	73
7.2.4.1	The information file	74
7.2.4.2	The setup file	74
7.2.5	Remote command strings	76
7.3	Main GUI	78
7.3.1	Menu bar overview	78
7.3.2	Toolbar	80
7.3.3	Docking Displays	81
7.3.3.1	Monitor 2DOF display	81
7.3.3.2	Data Display	83
7.3.3.3	Flystick	84
7.3.3.4	Measurement Tool	84
7.3.3.5	Event display	85
7.4	Menu <i>DTrack2</i>	86
7.4.1	License management	86

7.4.2	Configuration management	87
7.4.2.1	Backup of Configurations	88
7.4.2.2	Export System Information	88
7.4.3	Start/Stop	89
7.4.4	Controller standby	89
7.4.5	Quit	89
7.5	Menu Settings	90
7.5.1	Cameras Settings	90
7.5.2	Synccard Settings	91
7.5.2.1	Synccard Modes	92
7.5.2.2	Direct Settings	92
7.5.3	Inertial Sensor Settings	93
7.5.4	ART Radio Info	93
7.5.5	Tracking Settings	94
7.5.6	Body administration	95
7.5.6.1	Filtering options for 6DOF tracking data	97
7.5.7	Output Settings	100
7.5.8	Flystick Settings	101
7.5.9	Measurement Tool Settings	101
7.5.10	Advanced Controller Settings	101
7.5.10.1	Network Configuration	102
7.5.10.2	NTP Configuration	103
7.6	Menu Calibration	104
7.6.1	Static reflex suppression	104
7.6.2	Inertial Sensor Calibration	105
7.6.3	Room calibration	105
7.6.3.1	Room Calibration Progress	108
7.6.3.2	Room Calibration Results	109
7.6.3.3	Room re-calibration	109
7.6.4	Room adjustment	110
7.6.4.1	Transform the room coordinate system	113
7.6.5	Body calibration	114
7.6.5.1	Body calibration overview	114
7.6.5.2	Body calibration procedure	116
7.6.5.3	Body calibration result	117
7.6.5.4	Selecting the coordinate system for 6DOF targets	117
7.6.5.5	Selecting the coordinate system for 5DOF targets	118
7.6.5.6	Calibration with a calibration file	119
7.6.5.7	Body re-calibration	121
7.6.5.8	Target Library	121
7.6.6	Body adjustment	122
7.6.6.1	Graphic View	123
7.6.6.2	Changing of body geometry	124
7.6.7	Hybrid Body Calibration	125
7.6.8	Measurement Tool Calibration	125
7.7	Menu Display	125

7.8	Menu Tools	126
7.8.1	Controller Update	127
7.8.2	Measurement Tool Demo	127
7.9	Menu About	128
8	Frequently asked questions (FAQ)	130
8.1	Backup	130
8.2	Cameras	130
8.3	Controller	131
8.4	<i>DTrack2</i> and shutter glasses	131
8.5	<i>DTrack2</i> and interfaces	132
8.6	Software <i>DTrack2</i>	133
8.7	Calibration	136
8.8	Tracking	140
8.9	Flystick	142
8.10	Measurement Tool	143
8.11	Active Targets	144
8.12	<i>ART</i> tracking and 3D TVs	144
8.13	Radio transceivers used in <i>ART</i> products	144
9	General Information	145
9.1	Service	145
9.2	Cleaning of the equipment	145
9.3	Warranty and liability	145
9.4	Declaration of conformity	147
A	Technical specifications	151
A.1	<i>SMARTTRACK</i>	151
A.2	Flysticks	152
A.3	Overall system	153
A.4	System latency	154
B	Technical Appendix	155
B.1	Definition of Coordinates and Rotations	155
B.1.1	Room Calibration	155
B.1.1.1	Room Adjustment	155
B.1.2	Body Calibration	156
B.1.2.1	Definition of the Coordinates by the Body itself	156
B.1.2.2	Definition of the Coordinates by the Room Coordinate System, with Origin in the Center of the Markers	156
B.1.2.3	Definition of the Coordinates by the Room Coordinate System, with Origin in a Marker	156
B.1.2.4	Coordinate System Definition for 5DOF Targets (with and without cylinder markers)	157
B.1.2.5	Coordinate System Definition for two 5DOF Targets with cylinder markers	157

B.1.3	6DOF Results	157
B.1.4	3DOF Data	158
B.1.5	Flystick devices	158
	B.1.5.1 Flystick2	159
	B.1.5.2 Flystick3	159
B.1.6	Measurement Tools	160
	B.1.6.1 Orientation of a Measurement Tool	160
	B.1.6.2 Using a reference body	160
	B.1.6.3 Covariance of Measurement Tool tip	161
B.2	Output of Measurement Data via Ethernet	161
B.2.1	Frame Counter	162
B.2.2	Timestamp	162
B.2.3	Standard 6DOF Bodies	162
B.2.4	Standard 6DOF Bodies (extended format)	163
B.2.5	Flysticks	164
B.2.6	Flysticks (Old Format)	165
B.2.7	Measurement Tools with sphere tip	166
B.2.8	Measurement Tool references	167
B.2.9	Measurement Tools (Old Format)	168
B.2.10	Additional 3DOF Markers	168
B.2.11	Additional Informations	169
	List of Figures	170
	List of Tables	172
	Index	173

Terms and definitions

term	definition
3DOF	three degrees of freedom (i.e. only position)
6DOF	six degrees of freedom (i.e. position and orientation)
5DOF	five degrees of freedom (i.e. one degree less in orientation)
base	imaginary connecting line between the two integrated cameras of the SMARTTRACK
body calibration	teach the system the geometry of a rigid body
body, rigid body	rigid arrangement of multiple markers intended for 6DOF tracking (see also "target")
calibration angle (410mm)	belongs to the room calibration set and defines origin and orientation of the room coordinate system
ceiling suspension	equipment to mount the SMARTTRACK to the ceiling
DTrack2	
backend software	software running on the SMARTTRACK doing all necessary calculations
frontend software	graphical user interface running on customer's computer to control the SMARTTRACK
Flystick	wireless interaction device for virtual reality (VR) applications
hybrid tracking	sensor fusion of optical and inertial data into one consolidated output
inertial sensor	an inertial measurement unit simultaneously measures 9 physical properties, namely angular rates, linear accelerations (unused) and magnetic field components (unused) along all 3 axes. This is achieved using solid state gyroscopes for measurement of roll, pitch and yaw and optical tracking for drift correction.
infrared optical tracking	position measurement of bodies (subjects or objects) based upon infrared light and optical measurement procedures
license code (license key)	software key to unlock certain capabilities of the SMARTTRACK
marker	object either made of retro reflective material or LED for position tracking (3DOF)
Measurement Tool	a pointing device which allows to measure the position of the tool's tip with high accuracy
measurement volume	defines the volume where optical tracking is possible
modulated flash	infrared signal which is used for wireless synchronization
motion capture	track movements of a human body
mutual blinding	SMARTTRACK sees disturbing reflections caused by the infrared flashes of another SMARTTRACK
prediction	predicts output for the specified time in the future to compensate tracking and rendering latency
Radio Transceiver (integrated)	exchange data with Flystick
room calibration	teach the system the position of each camera and define origin and orientation of the room coordinate system
room calibration set	consists of angle and wand
synccard (integrated)	unit integrated in SMARTTRACK which serves for synchronizing the cameras
target	rigid arrangement of several single markers (= rigid body)
tracking	position measurement of bodies that move in a defined space
virtual point cloud	used for calculating the relative position of the SMARTTRACK
wand	precalibrated stick carrying two markers. The wand belongs to the room calibration set and is used to generate a virtual point cloud and to scale the system

1 Safety

1.1 Symbols and their meaning

You can find the following symbols and their signification on the equipment or in the manual:





	Useful and important notes.
	Important notes, which may lead to system malfunction or to the loss of warranty by non-observance.
	Important safety warning to assure operation safety. These warnings have to be considered, otherwise user and equipment could be endangered, the equipment could be damaged or the function of the equipment is not warranted.
	Safety warning for infrared radiation. These warnings have to be considered, otherwise users eyes could be endangered.

Table 1.1: Symbols and their meaning

1.2 Safety warnings



Safe operation of the equipment is only warranted if the warnings in this manual and on the equipment are observed.

- Never use the equipment if any part looks damaged.
- Safe operation is not possible, if
 - the housing is damaged,
 - any fluid attains in the housing,
 - objects attain inside the equipment,
 - the equipment shows any visible faults (smoke, sparks, fire, smells, etc.) or
 - the power cord is damaged.

- In any of the cases mentioned above (or similar) pull the power cord out of the power socket immediately. Otherwise, users or environment are endangered. Please contact the **ART** service.
- Never change or alter the equipment, neither mechanically nor electrically. Only the components described by **ART** shall be used. The conformity and the warranty of the producer (**ART**) expire by non-compliance.
- Never open the equipment! Only personnel authorized by **ART** is allowed to open the equipment. Inside of the equipment there are various hazards like high voltage, electric shocks - even if the equipment is disconnected - which can lead to death on contact. In case of malfunction of the equipment please contact the **ART** service.
- Only peripheral devices which meet the safety requirements of EN/IEC 60950 for extra low voltage may be attached on Ethernet-, BNC- and the DC-circuit of the equipment.
- The **SMARTTRACK** emits infrared light. Keep a distance of min. 20 cm when operating the **SMARTTRACK**. The **SMARTTRACK** is assigned to the Exempt Group according to IEC62471-1 and therefore poses no risk or hazard to the human eye or skin at this distance.
- Be sure that the cameras are firmly mounted in the correct position.
- Do not touch the front pane of the cameras, since the acrylic pane and the lens are highly sensitive surfaces. Be careful to avoid permanent damages (e.g. scratches). Only touch the housings of the cameras.
- The ventilation holes of the **SMARTTRACK** must not be covered. Air circulation is necessary to prevent the cameras from overheating. If the air circulation is restricted overheating will damage the cameras. The minimum distance between equipment and environmental objects has to be greater than 3 cm.
- The equipment has to be attached to a power socket with grounding. If the grounding wire is defective the requirement of the safety and the electromagnetic compatibility (EMC) are not guaranteed. To check the function of the grounding wire ask your regional located electrician.
- Before switching on any device, verify that voltage and frequency of your electric installation are within the allowed ranges of the equipment. The characteristics of the equipment can be found on the appliance rating plate or in chapter A on page 151. The appliance rating plates are on the equipment's housing (**SMARTTRACK** on the backside of the housing)
- The power switch on the backside does not completely separate the devices from the electricity network. To completely separate the equipment from the electricity network the power plug must be disconnected from the power socket. The power plug has to be accessible freely. The power socket must be close to the equipment.

1 Safety

- Please install the cables such that
 - no one can stumble over the cords,
 - the cords cannot be damaged,
 - the cords cannot damage the **SMARTTRACK** due to mechanical strain,
 - the line of sight of the **SMARTTRACK** is not obstructed.



Install a strain relief!

- Only use original **ART** (or **ART** authorized) components and accessories. Using non-original components or accessories may damage the equipment, cause malfunctions or may void operation safety. The provided components and original accessories can be found in chapters 4 on page 26, 4.2 on page 33 and 5 on page 36. Only use the originally provided external power supply for operating the **SMARTTRACK**
- The equipment must not be dropped and/or knocked.
- Do not use any solvents or water to clean the cameras. For more information about cleaning the cameras please read chapter 9.2 on page 145.
- Never expose the equipment to high levels of humidity or condensating humidity. Protect the cameras against water and chemicals.
- The equipment must not be operated in environments with intensive formation of dust or hot environments where temperatures rise above 40° C (100° F).



ART explicitly denies any liability or warranty if the product is modified in any way or not used according to this manual and the specification labels on the equipment.

2 Introduction

The **SMARTTRACK** is a fully integrated stand-alone infrared optical tracking system. It is designed to be used in small volumes (approx. 2m³). In this user manual we are going to perceive "tracking" as measurement of positional and rotational information (i.e. orientation) of objects or individuals that move in a defined space.

Concept of tracking The simultaneous measurement of spatial position (X, Y, Z) and orientation (three independent angles) is called "six degrees of freedom" (6DOF) tracking. If only the spatial position (X, Y, Z) is to be measured it is called "three degrees of freedom" (3DOF) tracking.

Single markers are sufficient if only 3DOF coordinates are needed, but single markers cannot be identified. **DTrack2** will assign an ID to a tracked 3DOF marker as long as it can be followed, but after losing the tracking (e.g. due to occlusions) it will not be able to re-identify the marker and thus assign a new ID.

For 6DOF tracking, however, a target is mandatory. Targets are unique and rigid arrangements of markers (=rigid bodies) and thus can be identified by their relative marker position. Figure 2.1 on page 16 shows the concept of infrared optical tracking with a two-camera system and a standard target.

The **SMARTTRACK** makes use of the same principle.

Marker types Passive markers are covered with retro reflective material - they act as light reflectors. Active light emitters (i.e. based on infrared LEDs) are called active markers (see chapter 3 on page 18).

Tracking in detail The cameras send out synchronized IR flashes which are reflected back into the lens by retro-reflective material covering the markers of the target. The integrated tracking cameras scan a certain volume, detect the IR radiation that is reflected by the markers and create a greyscale image based on the received IR radiation. The **SMARTTRACK** then calculates the 2DOF marker positions internally with high accuracy using pattern recognition algorithms.

Based on this 2DOF data the **SMARTTRACK** calculates 3DOF or 6DOF information. The base for this calculation is that the cameras' field of views are overlapping. **DTrack2** calculates the path of the optical rays from the cameras to the markers and delivers the ray intersections in three-dimensional coordinates. These intersections are the positions of the markers.

The position and orientation of the cameras is made known to the system during 'room

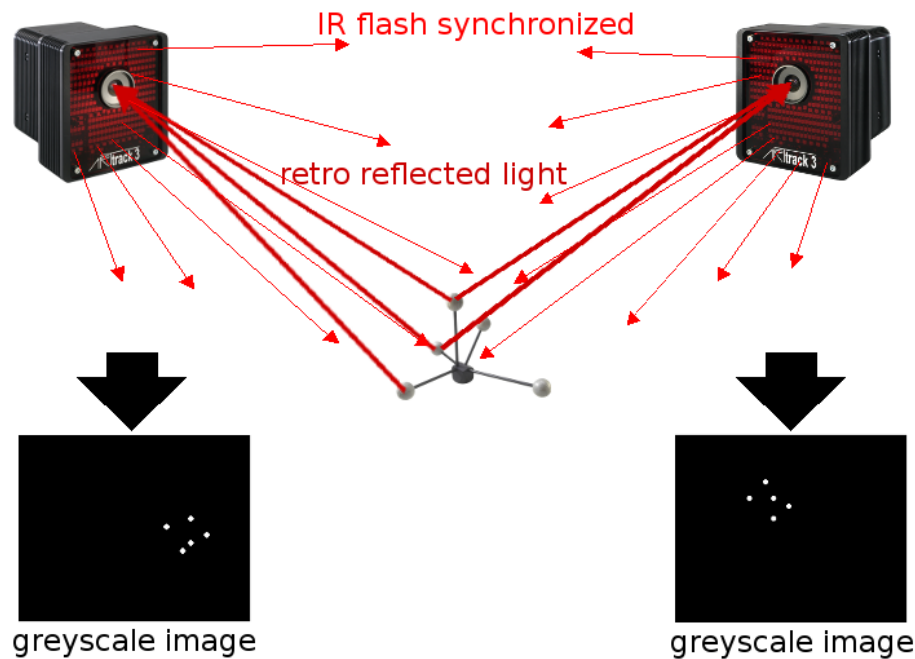

Figure 2.1: Concept of optical tracking (stereo vision)

calibration', while during 'body calibration' *DTrack2* identifies the unique arrangements of markers as targets. Based upon these two teaching steps, *DTrack2* is able to calculate 6DOF data and, finally, knows position and orientation of the target and therefore of the object or individual to be tracked.

Note: In pure optical tracking systems tracking is only possible as long as

- objects or individuals to be tracked are equipped with single markers or targets
- the target is not occluded by any other objects in the cameras' line of sight, which could even be the object itself
- the target is positioned inside the tracking range of the cameras
- at least four markers of a target are visible to at least two cameras (in more detail: to enable tracking).



The *SMARTTRACK* has a limited field-of-view and range! It is designed to be used in small volumes. Please refer to chapter 4 on page 26 for more information on the tracking volume of the *SMARTTRACK* .

Hybrid tracking In addition to tracking by a pure optical system it is possible to utilize data from inertial measurement units (IMU). These devices usually consist of several components such as gyroscopes, accelerometers and magnetometers. The underlying principle is the combination of solid-state microelectromechanical systems with integrated circuits and analog or digital outputs to achieve 6DOF rotational information.

Some of the most important advantages of hybrid tracking are:

- tracking data from IMUs offers low noise-levels while running at very high frequencies in combination with low latencies
- IMUs deliver tracking data (i.e. rotational information) even when the optical target is not inside the tracking volume or if the target cannot be tracked due to viewing limitations or occlusions
- drifting of IMUs (i.e. mostly from the 3-axis gyroscope) is compensated by fusing the inertial data with position measurements calculated from the optical tracking system

A hybrid target is basically an optical target additionally equipped with an IMU, which itself is connected to the **SMARTTRACK**. There the tracking data from both worlds (i.e. hybrid) is combined, which also leads to the term 'sensor fusion'. By nature the IMU contains an independent coordinate system which needs to be aligned to the optical tracking system axes. This additional teaching process is called hand-eye calibration or 'hybrid body calibration' in **DTrack2**.

3 Markers and targets (rigid bodies)

3.1 Passive markers

Passive markers used in *ART* tracking systems are retro-reflective, which means they reflect a high fraction of the incoming light in a small cone around the incoming light's direction (cat's eye effect). More precise: the IR radiation is reflected into a narrow range of angles around the (opposite) direction of the incoming light. Passive markers can be either

1. spherical markers:

- + excellent visibility from any perspective,
- expensive fabrication,
- sensitive surface,
- target requires larger volume → danger of mechanical damage.

2. flat markers:

- + low price,
- + flat targets possible,
- + robust surface because cover may be applied,
- the angular range of visibility is limited to approx. $\pm 45^\circ$.

3. ring markers:

- + low price,
- + cylindrically shaped targets possible,
- + robust surface,
- the angular range of visibility is limited to approx. $\pm 45^\circ$.

Passive markers are mostly spheres covered with retro reflecting foils. However, they can also be stickers made from retro reflecting material.

Retro reflecting sheets or foils available on the market can be based on two different optical principles:

1. Triple mirrors, which are arranged such that their planes form angles of 90° by pairs, are reflecting light in the described way. Mostly foils with arrangements of many very small mirrors in a plane are used.

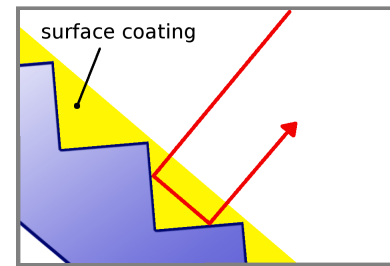

2. Glass spheres (with a proper refraction index) are focussing incoming light approximately to the opposite surface of the ball. A layer of microscopic glass spheres, carried by a reflecting material, acts as a retro reflector. These foils can be fabricated on a flexible carrier material, thus they are widely used for equipping spherical markers with retro reflecting surfaces.

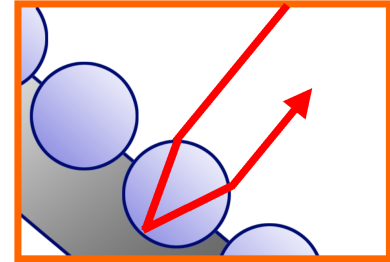

ART spherical markers are covered with retro reflecting foils, based on the glass spheres principle.



The quality of the markers decreases when they are in contact with dust, dirt, fat, liquids, glue or comparable contaminants. Please make sure that the markers are not touched or damaged.

3.2 Active markers

Basics Active markers are light (i.e. infrared light) emitting elements, usually LEDs.

In **ART** tracking systems four types of LED-based active markers may be used, depending on the application:

1. Single LEDs without diffusor sphere:

- + can be covered with acrylic protection film,
- + results in simple and robust markers providing visibility up to high distances (up to 10m),
- the angular range of visibility is limited to approx. $\pm 60^\circ$.

3 Markers and targets (rigid bodies)

2. Single LEDs with diffusor sphere:

- + for optimum angular range of visibility,
- distance between marker and tracking camera is limited to a short distance (up to 4.5m).

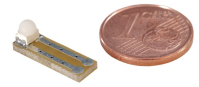

3. Big active spherical markers:

- + several single LEDs per marker, covered with light scattering spheres,
- + provide visibility from all sides and up to very high distances (approx. 20m),
- + suitable for outdoor tracking,
 - diameter: 50mm,
 - weight: 50g.

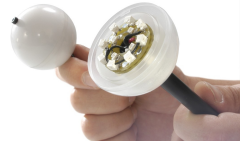

4. Big active flat markers:

- + several single LEDs per marker, covered with light scattering surface,
- + tracking up to very high distances (approx. 20m),
- + suitable for outdoor tracking,
- + magnetic base for easy positioning on metal surfaces,
 - the angular range of visibility is limited to less than 180° ,
 - diameter: 30mm.



All active markers provided by **ART** are controlled by a special PC board and need power supply.

Synchronization of active markers The easiest way to create an active marker is to have it emit IR light continuously. However, this would be inefficient in respect to energy dissipation and would yield low signal-to-noise ratios. **ART** tracking cameras have very short exposure times, i.e. narrow time slots of sensitivity. Most of the light emitted by the markers would hit the cameras sensors at times when it is inactive rendering the light useless for tracking. As a consequence, the range between cameras and marker would become significantly shorter. Additionally the active markers can be configured to emit high power intensities by flashing just like the camera flash. This also helps with energy dissipation due to an upper limit allowed for each single LED. Therefore, most active

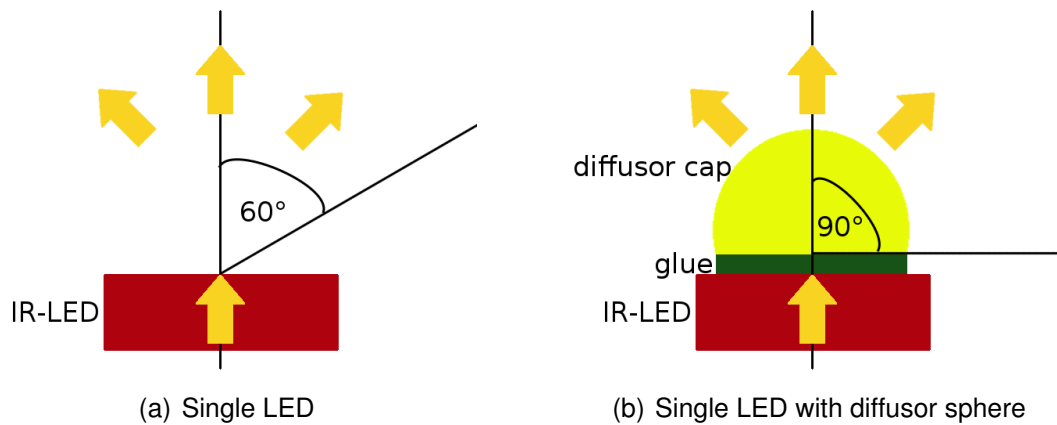







Figure 3.1: Angular range of visibility



markers supplied by **ART** are synchronized with the cameras to emit radiation only during exposure times. This allows both more robust and longer ranging targets.

Synchronization can be done either by a wired connection between the tracking system and the pc-board controlling the active markers but also in a wireless way. For wireless synchronization a coded (i.e. modulated) IR flash is being sent out by a tracking camera. The active marker's PC board recognizes the coded flash and activates the LEDs.

3.3 Standard targets

Type	Description	Weight	approx. Dimension	Marker size
Hand target 	The hand target is designed for hand tracking in usability and assembly studies respectively. It is also frequently used as a small general-purpose target. Due to the small size this target is easily occluded by the hand carrying it. Therefore, proper arrangement of tracking cameras has to be used in order to avoid occlusions.	25g / 0.9oz	(110 × 80 × 28)mm	12mm
Large hand target 	This hand target is designed for hand tracking in a two camera tracking system. Its large size allows to move the hand in almost all directions, without losing tracking.	30g / 1.1oz	(170 × 120 × 35)mm	12mm
Claw target 	The claw target looks just the same as the hand target. But it comes in a bigger size and is equipped with bigger markers.	35g / 1.2oz	(160 × 110 × 30)mm	16mm

Type	Description	Weight	approx. Dimension	Marker size
Tree target 	Originally designed for tracking HMDs, the tree target is a general-purpose target for tracking from longer distances. It is equipped with 20mm markers.	75g / 2.65oz	(195 × 170 × 120)mm	20mm
Generic glasses target 	For head tracking mostly in passive stereo systems, tracking targets must be fixed to the stereo glasses. <i>ART</i> offers several light-weight standard targets for this purpose.	min: 14g / 0.5oz max: 22g / 0.7oz	(270 × 120 × 35)mm	12mm
INFITEC PREMIUM target 	Target tailored to the INFITEC PREMIUM passive stereo glasses.	26g / 0.9oz	(225 × 85 × 80)mm	12mm

Type	Description	Weight	approx. Dimension	Marker size
CrystalEyes [®] 2/3 target 	Target tailored to the shutter glasses of the StereoGraphics active stereo system. It fits to both CrystalEyes [®] 2 and 3.	28g / 1oz	(215 × 120 × 60)mm	12mm
CrystalEyes [®] 5 target 	Target tailored to the shutter glasses of the StereoGraphics active stereo system. It fits to the CrystalEyes [®] 5.	19g / 0.7oz	(195 × 105 × 40)mm	12mm
NuVision APG6000 and APG6100 target 	Target tailored to the NuVision APG6000 and APG6100 shutter glasses.	17g / 0.6 oz	(220 × 125 × 75)mm	12mm

Type	Description	Weight	approx. Dimension	Marker size
Volfoni EDGE® target 	Target tailored to the Volfoni EDGE® shutter glasses.	23g / 0.7 oz	(230 × 95 × 60)mm	12mm
NVIDIA 3D Vision® Pro target 	Target tailored to the NVidia 3D Vision Pro shutter glasses.	25g / 0.9 oz	(225 × 100 × 60)mm	12mm
NVisor SX 60 target 	Target tailored to the NVisor SX 60 head mounted display.	55g / 1.94oz	(300 × 215 × 35)mm	12mm

Table 3.3: Standard targets overview

4 System setup

4.1 Installation of the *SMARTTRACK*

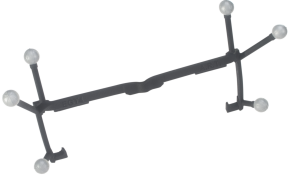
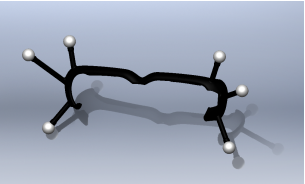
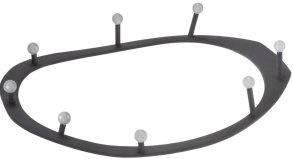

Keep a distance of min. 20 cm when operating the *SMARTTRACK* !
The *SMARTTRACK* is assigned to the Exempt Group according to IEC62471-1 and therefore poses no risk or hazard to the human eye or skin at this distance.

Description The *SMARTTRACK* is a fully integrated stand-alone infrared optical tracking system. It is designed to be used in small volumes of approx. 2m³. The typical tracking volume of the *SMARTTRACK* is illustrated in figure 4.2 on page 27.

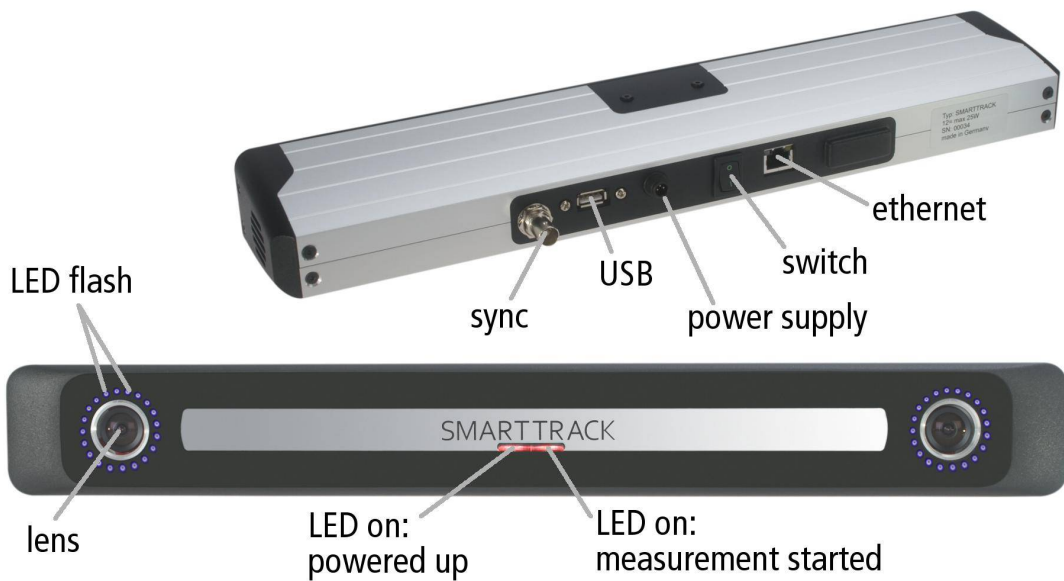

Figure 4.1: *SMARTTRACK*

4.1.1 Ports & Plugs on the *SMARTTRACK*

The following list gives a short overview of all ports accessible to the user. (see figure 4.1 on 26):

- Sync ('ExtIn'):
Please plug in the external source (TTL or video signal) for synchronization here.

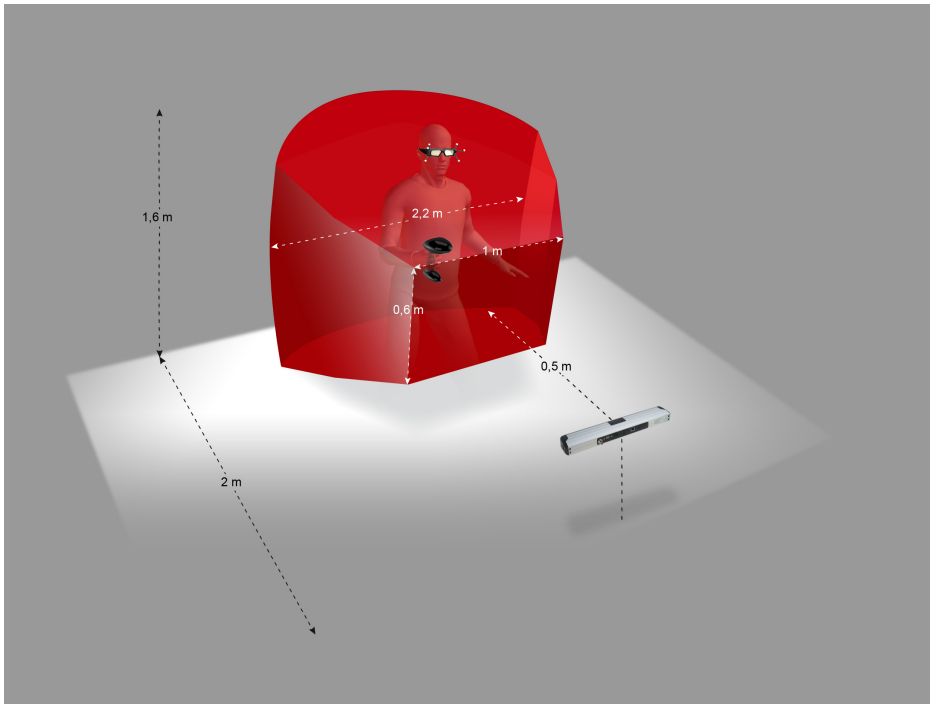

Figure 4.2: 3D Visualization of the tracking volume

- USB port:
Please plug in a USB pen drive for accessing the **SMARTTRACK** without the **DTrack2** front-end (refer to chapter 7.2.4 on page 73).
- Power supply:
Please connect the **SMARTTRACK** with the provided power supply.
- Switch:
Flip the power switch to 'I' to start the **SMARTTRACK** .
- LAN network port:
Please connect the **SMARTTRACK** to your local network using an RJ45 cable.

4.1.2 External synchronization

The **SMARTTRACK** can be synchronized with an external source. On the back of the **SMARTTRACK** there is a BNC plug 'ExtIn' which serves as input for the external synchronization signal. The sync signal may be of type TTL (5V) or video. Using TTL you can select between rising and falling edge (see also chapter 7.5.2 on page 91).

Typically, external synchronization has to be used when other systems inside the **SMARTTRACK** tracking volume are also using infrared signals for controlling their equipment (e.g. if IR-controlled shutter glasses are used). The goal is to reduce or eliminate interference. The **SMARTTRACK** follows the external synchronization signal and chooses time slots when it is safe to emit infrared radiation without causing interference. The effect is,

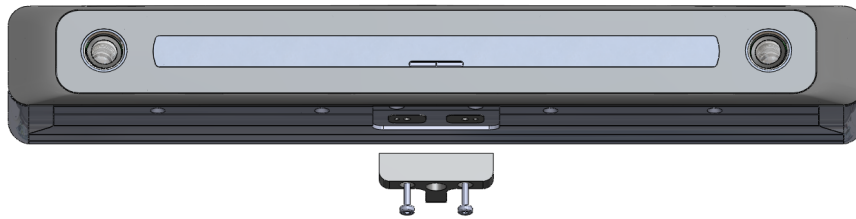

Figure 4.3: Attaching the T-piece to the **SMARTTRACK**

for example, that active shutter glasses are not flickering but offer a stable picture for the user.



The external sync input is not internally terminated. When synchronizing with a video input, a tee connector with an external 75 Ω terminating resistor should be used if the signal line ends at the SMARTTRACK. When using a TTL-signal you should not use a terminating resistor. However, you should use a shielded cable for the synchronization with a TTL-signal.

4.1.3 Mounting

The **SMARTTRACK** is optimized for a predefined measurement volume. System operation in bigger measurement volumes can lead to reduced accuracy. The measurement volume can be adjusted within certain limits simply by changing the flash intensity of the **SMARTTRACK** (see chapter 7.5.1 on page 90).



The flash intensities should not be too high. In general, a flash intensity of 4-5 might be sufficient.

Be aware that tracking is very sensitive to camera movements. Therefore the **SMARTTRACK** has to be mounted in a way that camera movements (especially vibrations) are reduced as much as possible.



Mounting on tripods may be sufficient for presentations and preliminary installations, but is not recommended as a final solution!

If you want to mount the **SMARTTRACK** on a tripod just mount the carrier on the bottom of the **SMARTTRACK** housing. Attach the carrier with the T-piece pointing to the back of the **SMARTTRACK** as seen in figure 4.3 on page 28). In general the carrier with the T-piece can be attached on both bottom and top side of the **SMARTTRACK**.

Feel free to contact **ART** in case you want to realise a more complex installation. We will assist you in your planning.



Only use screws supplied with the carrier for mounting it. Also, use all the parts supplied with the ceiling mount - especially the toothed washer is quite important.



You shall never unfasten other screws on the *SMARTTRACK* (see chapter 1.2 on page 12). Otherwise, the *SMARTTRACK* might be damaged and liability and warranty is void.



Please make sure that the ventilation holes are not covered.

It is recommended to install the power supply for the *SMARTTRACK* in a way that enables you to switch of the *SMARTTRACK* by a main switch. If this is done, the *SMARTTRACK* can be easily turned off and on without changing its position.

Make sure to install the *SMARTTRACK* in a way that you can easily access its cables. Be especially careful to mount the *SMARTTRACK* firmly so it cannot fall down. If unsecured, it may pose a serious hazard to health and safety.



Avoid hard shocks at all times! A new calibration at the ART facilities might become necessary in that case.

Please install the cables such that

- no one can stumble over the cords,
- the cords cannot be damaged,
- the cords cannot damage the *SMARTTRACK* due to mechanical strain,
- the line of sight of the *SMARTTRACK* is not obstructed.



Inappropriate cabling may pose a serious hazard to health and safety. Cable ducts or fixings should be used and a strain relief should be installed!

To avoid measurement problems, no light sources or highly reflecting areas should be visible to the *SMARTTRACK* . Especially strong point light sources like e.g. halogen lamps and direct or reflected sunlight may imply problems for the measurement (fluorescent lamps are ok).

4.1.4 Camera orientation

After mounting and connecting the *SMARTTRACK* , the next step is to adjust its orientation such that the measurement volume is covered completely by tracking volume of the *SMARTTRACK* . Mounting has to ensure that tracking is possible over the entire measurement volume. Additionally it is important to remove disturbing reflections (refer to 4.1.5 on page 30) . Therefore, as part of its GUI *DTrack2* provides the *Monitor 2DOF display* which is essentially a 2-dimensional graphical display of all markers / flashes or

4 System setup

other IR sources that can be seen inside the tracking volume of the **SMARTTRACK**. At this point, you will probably find it most useful to become acquainted with the graphical user interface and the main window of **DTrack2**. Please refer to chapter 7.3 on page 78.

4.1.5 Localizing and removing of disturbing reflections

Possible sources of disturbing reflections may be diverse. Still all of them may be detected when starting the *Monitor 2DOF display* in **DTrack2**. They are illustrated the same way as markers, i.e. with small coloured crosses or circles, depending on the distance to the **SMARTTRACK** (see figure 4.4 on page 30).

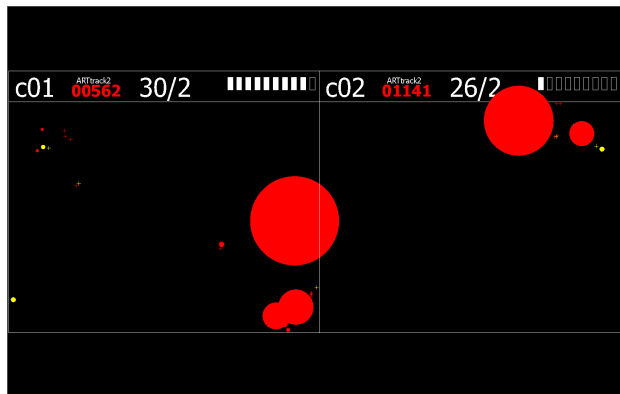

Figure 4.4: Typical situation arising from reflections through sunlight

Typically the reflections arise from one (or more) of the following points:

- active or passive targets that are inside the FoV / tracking range of the cameras,
- strong IR sources (e.g. sunlight or sunrays, halogen lamps, ...),
- any kind of reflective material on clothes or shoes (e.g. reflective tape on safety vests),
- blank metal surfaces that act as mirrors, especially curved surfaces and polished surfaces with 90° angles,
- some types of packaging foils.

For localising and removing disturbing reflections follow this simple approach:

- active targets or IR sources: reduce the flash intensity of the **SMARTTRACK** to '0'
Try to localize and remove the remaining markers / reflections which originate from infrared radiation sources (e.g. sunlight, halogen lamps, ...).
- other non-specific reflections: set the flash intensity of the **SMARTTRACK** to '4'
Try to localize the reflection by moving a target or reflective marker towards the origin of the reflection (use the *Monitor 2DOF display*) and remove it.

If, by any means, reflections cannot be eliminated completely you may use the static reflex suppression of **DTrack2** (please refer to chapter 7.6.1 on page 104).



Be aware that reflex suppression leads to decreased tracking volume by blocking the area in which the reflection originated.

Static reflex suppression You may also take advantage of the functionality of static reflex suppression, i.e. blocking individual areas of the FoV / measurement volume to eliminate disturbing reflections. **DTrack2** and the **SMARTTRACK** are able to suppress all reflections in certain areas of the image sensor. Scanning for static reflections allows searching the tracking volume for unwanted reflections. Areas are defined on top of the visible reflections, where all data on the image sensor is neglected during measurements. This is especially important for setups in the corner of a room: the cameras of the **SMARTTRACK** usually get a lot of unwanted reflections from the nearby walls. To gain good tracking results, these reflections should be suppressed. Be aware that the tracking volume will be decreased, which is why reflex suppression should always be the last option to be considered. If possible, try adjusting the **SMARTTRACK** in order to minimize reflections.

Please refer to chapter 7.6.1 on page 104 for further details.



Be aware that reflex suppression leads to decreased tracking volume by blocking the area in which the reflection originated.

4.1.6 Room Calibration overview

The **SMARTTRACK** is pre-calibrated. By default, the origin of the calibration system lies centered between the two status LEDs in the front. The orientation is as shown in figure 4.5 on page 31.

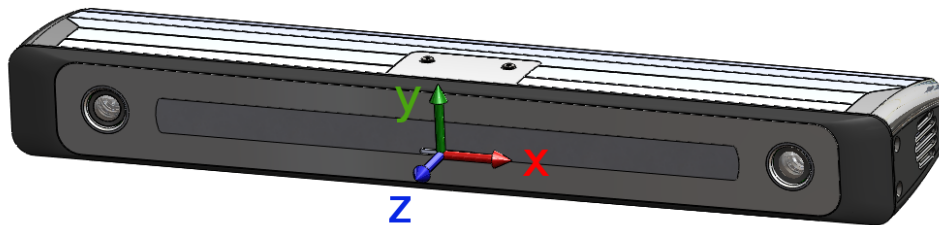



Figure 4.5: Origin of the room coordinate system (default)

4 System setup

If this default orientation and position of the coordinate system (i.e. 'Middle of cameras', see figure 4.5) is not adequate for your application, it will still be possible to perform a new room calibration with the **SMARTTRACK**. During this calibration, the system identifies the position of the **SMARTTRACK** inside the measurement volume and determines the three-dimensional coordinate system of the room relative to the calibration angle (refer to table 7.16 on page 108).

 **It is recommended to perform a room (re-)calibration on a regular basis (e.g. after a certain operating time of the SMARTTRACK) and especially if the SMARTTRACK was subject to extreme vibrations or changing environmental conditions (e.g. high or low temperatures).**

 **Example: If the SMARTTRACK is rotated by one tenth of a degree it will cause aberrations of the optical rays that are as high as 4 millimetres in 2 metres distance from the SMARTTRACK. This will result in shifts of the room coordinate system.**

In summary room calibration has to be carried out

- when the default orientation and position of the **SMARTTRACK** coordinate system is not adequate for your application
- whenever any uncertainty regarding environmental conditions occurs.

Room calibration hardware For room calibration, the calibration angle (see figure 4.6 on page 32) of the "room calibration set" is put inside the tracking volume of the **SMARTTRACK**. The position of the calibration angle defines the room coordinates. The pre-calibrated stick carrying two markers is called the "wand". Its function is to create a virtual "point cloud" in the measurement volume that is used for calculating the relative positions of the IR cameras with high accuracy. Furthermore, the wand is scaling the system. That's why damages of the wand (loose markers, bent poles, etc.) lead to miscalculations of the measurement volume.



Figure 4.6: A room calibration set consisting of angle and wand

Room calibration process Both cameras of the *SMARTTRACK* have to see all markers of the calibration angle as well as the two markers of the wand. Move the wand gently in all possible directions (up/down, left/right, back/forth) and additionally rotate it within the measurement volume (see red volume in figure 4.2 on page 27). If possible, try to walk around to generate a virtual point cloud in all dimensions (see figure 4.7 on page 33). It is used for calculation of the position of the internal cameras of the *SMARTTRACK*, so moving the wand in only a very small volume will result in reduced accuracy of calibration. Also avoid quick and jerky movements. Please refer to chapter 7.6.3 on page 105 for further details of the procedure.

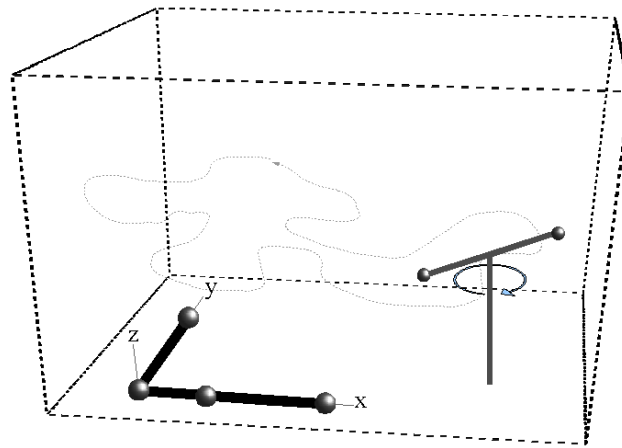

Figure 4.7: Room calibration process



The point cloud should fill at least two thirds of the measurement volume. Moving the wand in a restricted volume will result in reduced accuracy of calibration or failure.

4.2 The integrated controller inside the *SMARTTRACK*

The *SMARTTRACK* is an integrated tracking system. This means, inside the small housing we integrated not only two tracking cameras but also the Controller which performs all calculations and generates the data output stream.

Thus for the sake of readability the *SMARTTRACK* is also referred to as 'Controller' in the following sections.

The software *DTrack2* consists of frontend and backend software. The frontend software is installed on a remote PC which is connected to the controller via Ethernet. A GUI for easy handling enables the user to control the *SMARTTRACK* completely from the remote PC. The benefit is that the system becomes more flexible, i.e. different users can control the *SMARTTRACK* at any one time (but not simultaneously!) from different working places.

Furthermore, *DTrack2* provides the possibility to control its functions via Ethernet (i.e. without the *DTrack2* frontend software). This is done by establishing a TCP/IP connec-

tion with the controller and exchanging short command strings (refer to chapter 7.2.5 on page 76). Please contact **ART** if you are interested in using this feature.

The backend software runs on the integrated controller - all necessary calculations (3DOF, 6DOF data, ...) are performed there. The data and control commands are interchanged via a TCP/IP connection between the controller and the **DTrack2** frontend software on the remote PC. Data output to the application or graphics workstation is done via a UDP connection.

Interaction devices can be accessed directly via the integrated radio transceiver (refer to chapter 5 on page 36).

4.2.1 Connection to local network LAN

The integrated controller uses the 'LAN network port' (100 Base-TX) for data output to the remote PC or to any PC within the local network. Figure 4.8 on page 35 shows two possibilities of connecting the controller to a local network. You may either use the controller as a DHCP client within your network (figure 4.8(a)), i.e. the tracking data is transmitted directly via your local network. Or in case of security restrictions (e.g. company guidelines, that do not allow to connect the controller to your network), you may install two network cards in your remote PC - one is connected to the controller and the other one is connected to your local network (figure 4.8(b)). In this case, the **DTrack2** frontend will act as a router for the tracking data.

By default the controller is set up to support DHCP. Therefore, it will acquire an IP address automatically given that a DHCP server is running.

Double-check that the **SMARTTRACK** is connected to its power supply, connect the 'LAN network port' to your local network and connect the plug of the power supply to a power socket. Flip the power switch on the back of the **SMARTTRACK** to 'I'. Finally, start the **DTrack2** frontend software on the remote PC. Please refer to chapter 7 on page 67 for more details.



If the controller is not connected via an ethernet cable or no DHCP server is running, it will use its fall-back IP address (IP 192.168.0.1, subnet mask 255.255.255.0)

You may configure a static IP address the following ways:

- using **DTrack2** (refer to chapter 7.2.2 on page 71)
- without the **DTrack2** frontend (refer to chapter 7.2.4 on page 73)



Please note that these settings are not part of your personal configuration. Changes of the IP address will affect all users of your controller! Your controller may become unreachable with wrong IP settings! Refer to chapter 7.2.4 on page 73).

4.2 The integrated controller inside the SMARTTRACK

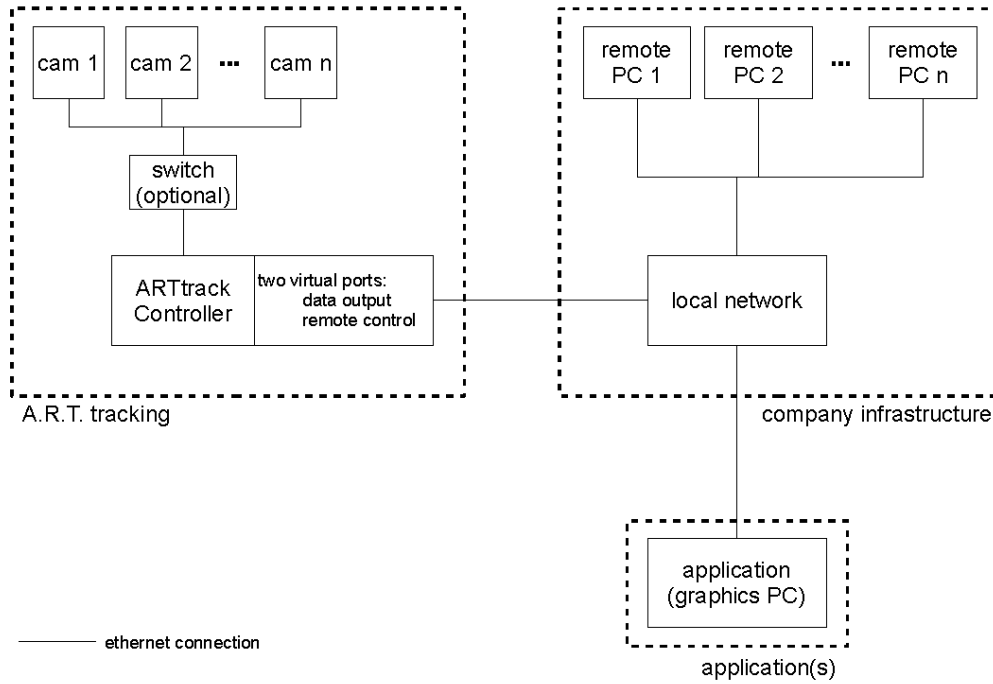

(a) standard connection

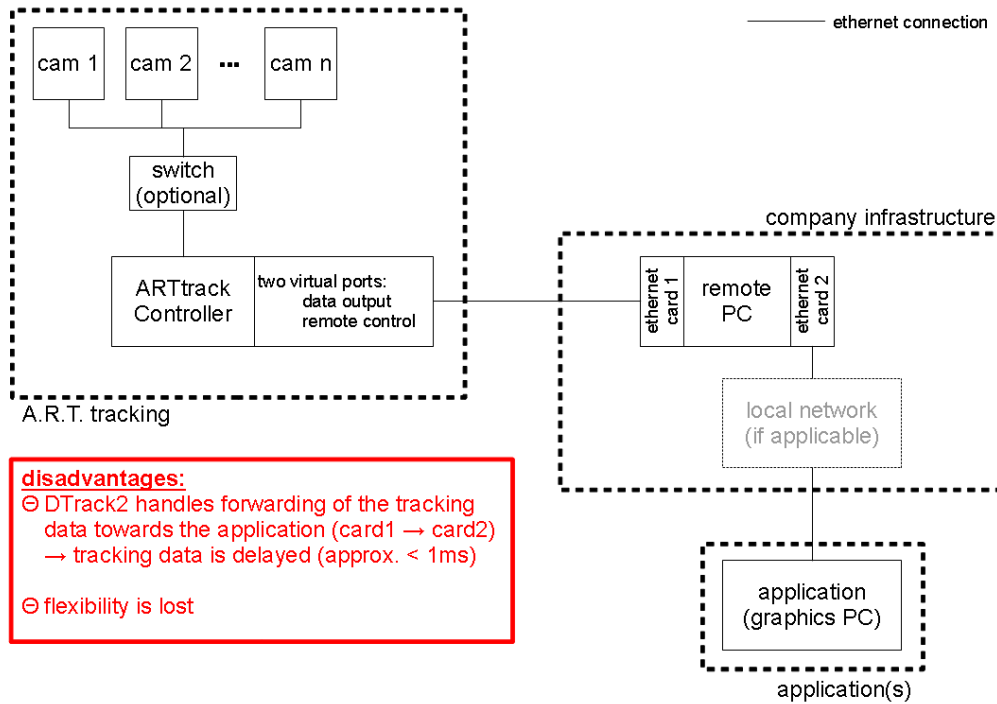

disadvantages:
 ⊖ DTrack2 handles forwarding of the tracking data towards the application (card1 → card2)
 → tracking data is delayed (approx. < 1ms)
 ⊖ flexibility is lost

(b) indirect connection

Figure 4.8: Connecting the SMARTTRACK to a local network

5 Interaction devices

5.1 Flystick2



The batteries must be removed before shipping the Flystick2, otherwise the radio transmitter could be started by shock or vibration.

Description The Flystick2 is a wireless input device for *ART* infrared optical tracking systems.



Figure 5.1: Flystick2

The Flystick2 has a trigger, four buttons and an analogue joystick with an additional button functionality. All interactions are transmitted wirelessly via a 2.4 GHz ISM radio connection. The software *DTrack2* takes up the Flystick2 button & joystick events and correlates them with the 6DOF output data. Tracking and interaction data are then transmitted to the application via Ethernet.

5.1.1 Control elements

The numbering sequence of the buttons is as follows:

- # 1 trigger
- # 2 - # 4 blue buttons, right to left
- # 5 pressing the joystick



Figure 5.2: Flystick2 control elements

Top View	Event	Description
	green pulse	button pressed or joystick position successfully transmitted
status LEDs	yellow pulse	button pressed or joystick position could not be transmitted
	yellow flickering	low battery, recharge soon
trigger, button and joystick		press the trigger or any button to invoke an interaction which can be defined in the user application (e.g. drag objects while button trigger pressed, open a menu dialogue, ...)

Table 5.1: Description of the Flystick2

In neutral position the joystick transmits $x=0$, $y=0$.

- Moving left creates negative x values, moving right positive x values.
- Moving down creates negative y values, moving up positive y values.
- Full extension into any direction creates values of 1.0 or -1.0.

The Flystick2 device provides all functions (buttons, trigger and joystick) simultaneously. In case you need to carry out a factory reset for the Flystick2 you just have to plugin the charger into the charging jack.



The Flystick2 has no power switch. It is activated automatically within a few seconds after any button event and is deactivated after several minutes without usage.

The Flystick2 is tracked via passive markers which are covered by an acrylic housing. This means that 6DOF tracking is still valid when the Flystick2 electronics is off.

Data output The output data consists of:

- position and orientation of the Flystick,
- status of buttons and joystick,
- number of used Flysticks.

Please refer to chapter B on page 155 for more information about the format of the output data.

5.1.2 Battery pack

The battery compartment is at the lower end of the handle. It is fixed with a single screw which can be opened with the supplied 2mm hexagon key. Remove the screw and take off the cover of the battery compartment.

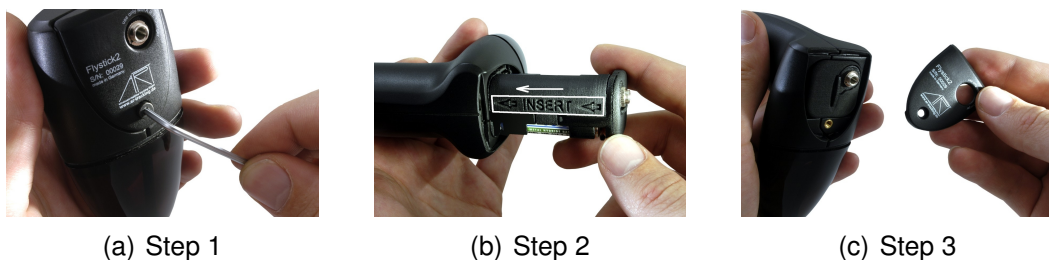

Figure 5.3: Flystick2 - inserting the battery pack

Insert the battery pack taking care of the polarity - also note the imprinting "<<INSERT<<" on the battery pack. Apply the cover of the battery compartment again and fix the screw.



The battery pack includes 3 standard AAA rechargeable batteries.



The polarity of the batteries is indicated inside the battery pack. The rechargeable batteries must be inserted into the battery pack in the indicated polarity.

Dispose used batteries according to governmental regulations (life cycle approximately 2 years).



Risk of explosion if battery is replaced by an incorrect type!

Charging jack The charging jack is at the bottom of the handle and has to be connected with the supplied battery charger.



Figure 5.4: Charging the battery of the Flystick2

By connecting the battery charger the Flystick2 electronics are disconnected to prevent damage. Thus the Flystick2 cannot be used during the the charging process.



The rechargeable batteries may only be charged with the supplied charger. To ensure long battery life, do not let the batteries become discharged completely. Recharge whenever convenient. Do not charge for > 24 h.

Battery charger A battery charger is supplied with the delivered Flystick2 and must be used for charging the batteries. For your convenience, the battery pack may remain inside the Flystick2 for charging. However, during the charging process the Flystick2 cannot be used.

As soon as the battery pack is connected to the charger the initialisation starts (status LED: Yellow). After a few seconds the charger switches to the fast-charge mode (status LED: Orange).

Once the battery pack is fully charged (approx. 1 h) the charger balances the cells inside the battery pack ('top-off charge mode', status LED: Green with intermittent yellow flash) to help extend battery life. Hereafter the charger goes into trickle charge mode automatically (status LED: Green). Now, the battery pack may be used again.

Please also refer to table 5.2 on page 40 for an overview of the status LEDs on the battery charger.

status LED colour	Description
Yellow	No battery pack connected or initialisation
Orange	Fast charge
Green with Yellow flash	Top-off charge (balancing)
Green	Trickle charge (charging completed)
Flickering Orange - Green	Error (disconnect !)

Table 5.2: Status LEDs quick reference

5.1.3 Radio module

The Flystick2 uses a radio module in the 2.4GHz band. This band is standardized internationally and can be used without a license. Range with line of sight is more than 7m but can be reduced when passing material, e.g. projection screens.

5.2 Flystick3



The batteries must be removed before shipping the Flystick3, otherwise the radio transmitter could be started by shock or vibration.

Description The Flystick3 is a lightweight input device for **ART** infrared optical tracking systems.



(a) active target (discontinued)



(b) passive target (standard)

Figure 5.5: Flystick3

It is equipped with an active¹ or passive target, a trigger, three buttons and an analogue joystick for wireless interaction in a virtual environment. All interactions are transmitted wirelessly via a 2.4 GHz ISM radio connection. Synchronization of the active Flystick3 (discontinued) is provided wirelessly with a modulated flash by one camera.

¹discontinued in December 2011

The software *DTrack2* takes up the Flystick3 button and joystick events and correlates them with the 6DOF output data. Tracking and interaction data are then transmitted to the application via Ethernet.

 **The radio transmission and the active target are switched off after 15 minutes without usage. Press any button to reactivate the Flystick3 and, therefore, tracking.**

5.2.1 Control elements

The numbering sequence of the buttons is as follows:

- # 1 trigger
- # 2 - # 4 blue buttons, right to left

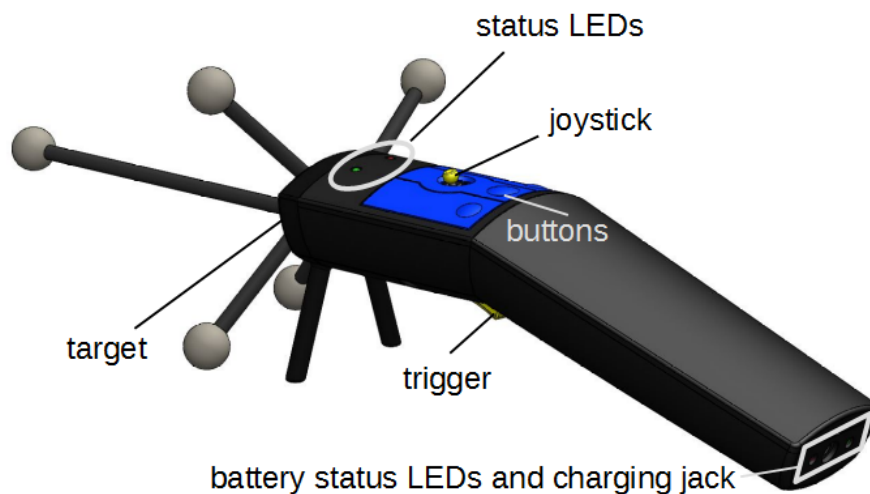

Figure 5.6: Flystick3 control elements

Top View	Event	Description
	green pulse	button pressed or joystick position successfully transmitted
status LEDs	yellow pulse	button pressed or joystick position could not be transmitted
	yellow (and green) flickering	low battery, recharge soon
trigger, button and joystick		press the trigger or any button to invoke an interaction which can be defined in the user application (e.g. drag objects while button trigger pressed, open a menu dialogue, ...)

Table 5.3: Description of the Flystick3

In neutral position the joystick transmits $x=0$, $y=0$.

5 Interaction devices

- Moving left creates negative x values, moving right positive x values.
- Moving down creates negative y values, moving up positive y values.
- Full extension into any direction creates values of 1.0 or -1.0.

The Flystick3 device provides all functions (buttons, trigger and joystick) simultaneously.

In case you need to carry out a factory reset for the Flystick3 you will find the reset button just on top of the charging jack. You may use a paper clip to press the reset button.

Data output The output data consists of:

- position and orientation of the Flystick,
- status of buttons and joystick,
- number of used Flysticks.

Please refer to chapter B on page 155 for more information about the format of the output data.

5.2.2 Battery pack

Inserting the battery For inserting the battery into the Flystick3, you have to take off the back cover completely.

Therefore, loosen the four screws using the 2.5mm hexagon key and remove the back cover.

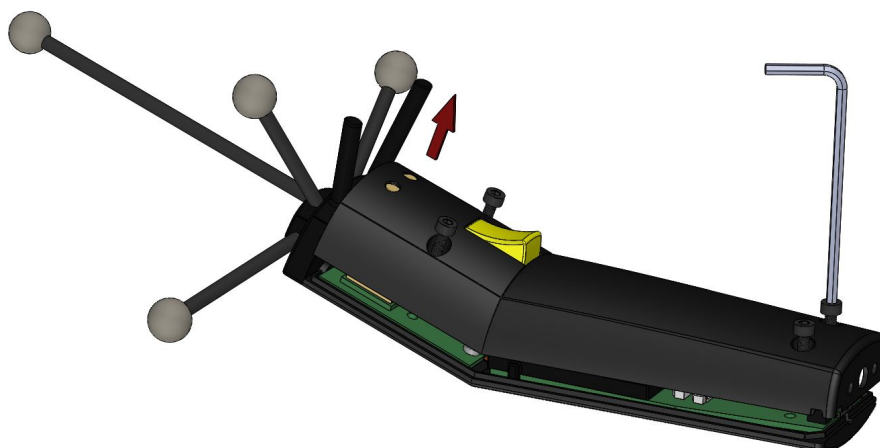

Figure 5.7: Open the battery compartment of Flystick3

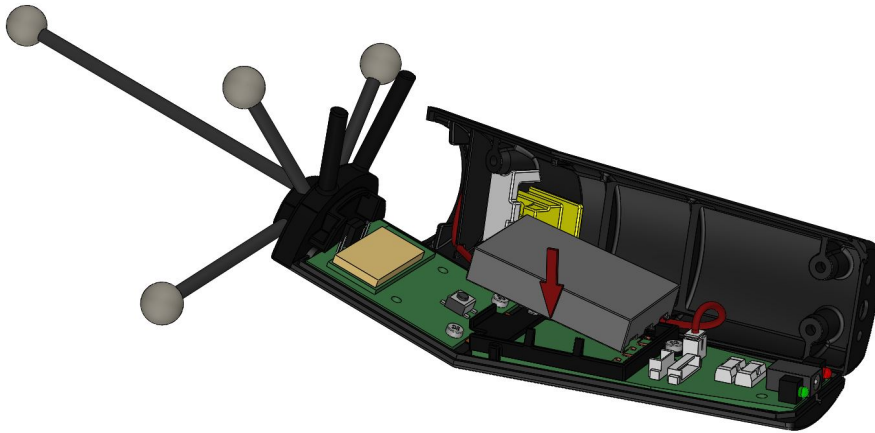

Figure 5.8: Insert new battery in Flystick3

Place the battery correctly within the cut-out.



Risk of explosion if battery is replaced by an incorrect type!



Dispose of used batteries according to governmental regulations.

Apply the back cover again and tighten the screws carefully.

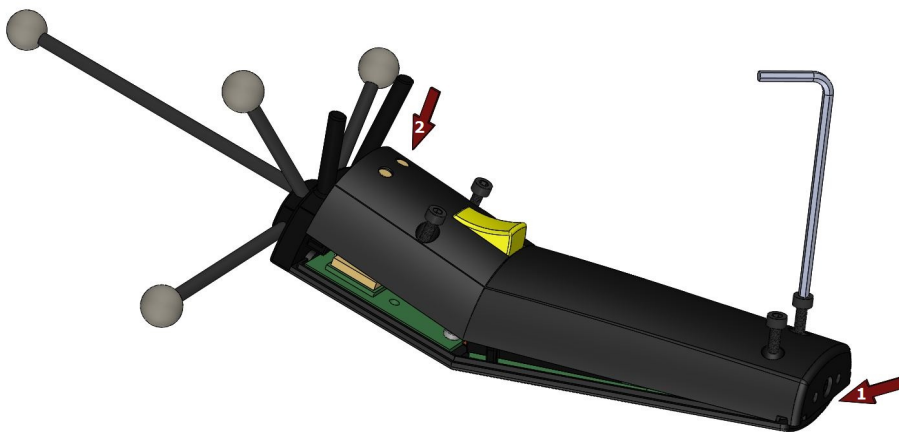

Figure 5.9: Close the battery compartment of Flystick3

Battery charger A battery charger is supplied with the delivered Flystick3 and must be used for charging the batteries. For your convenience, the battery pack may remain inside the Flystick3 for charging. During the charging process you may continue using your Flystick3.

As soon as the battery pack is connected to the charger, the red LED ("Charge") is switched on. Once the battery pack is fully charged the charger switches off the "Charge" LED, the green "Ready" LED is switched on. Now, the battery pack may be used again.



The rechargeable batteries may only be charged with the supplied charger.

If the green LED is switched on permanently and the red LED is flashing at the same time an error occurred during charging. The battery may be defective or it has been wrongly inserted.

5.2.3 Radio module

The Flystick3 uses a radio module in the 2.4GHz band. This band is standardized internationally and can be used without a license. Range with line of sight is more than 7m but can be reduced when passing material, e.g. projection screens.

5.2.4 Wireless synchronization (active Flystick3 discontinued)

The receiver for the modulated infrared signal which is used for synchronization is located in the middle of the joint between transparent target and handpiece.

Active targets need synchronization in order to make sure that the IR LEDs are flashing at the proper time. To ensure wireless synchronization the following points should be observed:



- **Note that the synchronization will not work near plasma screens.**
- **If two or more tracking systems using wireless synchronization are in the same room, then external synchronization of the systems might be necessary (e.g. at tradeshow).**

The modulated flash is adjustable in *Settings* → *Cameras*. Just tick the checkbox 'modulated flash'. Press *OK* to apply the changed settings.

5.3 Flystick Installation

5.3.1 Radio Transceiver



The **SMARTTRACK** comes with an integrated radio transceiver. There is no need to plug in an additional USB Radio Transceiver (RT3)

The Radio Transceiver is configured automatically. In case you need to change settings manually please refer to chapter 7.5.4 on page 93.

5.3.2 Flystick Configuration

Next configure the number of Flysticks you are using: Select *Settings* → *Flystick* and configure the *number of Flysticks* (see figure 5.10 on page 45).

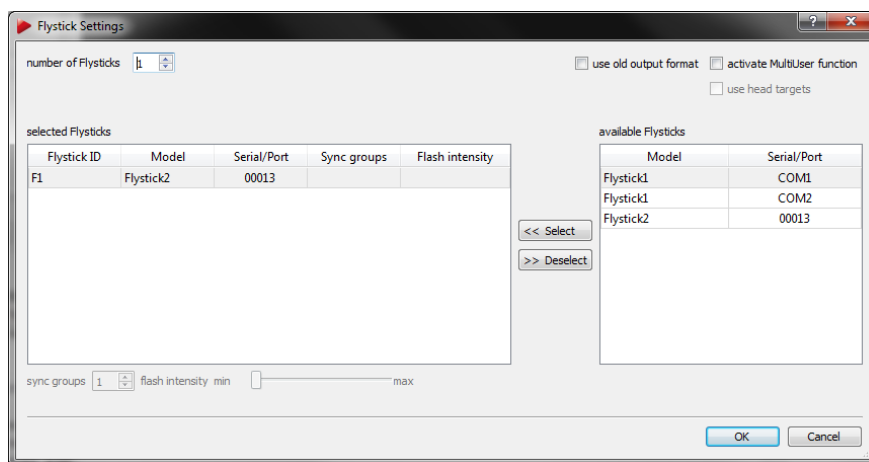

Figure 5.10: Flystick Settings

As soon as you change the *number of Flysticks* entries in the *selected Flysticks* field will pop up. The fields *Model*, *Serial* and *Port* are empty by default.

Make sure that your Flystick is in the *available Flysticks* list - if necessary, compare the serial number listed here to the one printed on the battery compartment of the Flystick2 or on the back cover of the Flystick3.

Now, you have to assign your Flystick to a '*Flystick ID*'. Therefore,

- mark the respective Flystick ID, e.g. '*F1*', by selecting it from the '*available Flysticks*' list
- mark the desired available Flystick and
- press *Select* to finalize the assignment.



If the '*available Flysticks*' list doesn't contain your Flystick although it is already present, just press any button of the Flystick to register it at the radio transceiver.

Repeat these steps if you want to use another Flystick.



There are two predefined entries for Flystick1 in the list *available Flysticks*, even if no Flystick1 is present in the volume. This is due to the fact that the Flystick1 connects via serial COMport which cannot be polled automatically. If you are using a Flystick1 please refer to the Flystick1 manual.

Inside the dialogue you can also configure the following settings for your Flystick:

Checkbox	Description
<i>use old output format</i>	Use the output format of the Flystick1 (see chapter B on page 155)
<i>activate MultiUser function</i>	Refer to page 46 in chapter 5.1 on page 36 for more information.
<i>use head targets</i>	The data pair (Flystick and head target) of one user is made available as output data (if MultiUser function is activated).
Option (active Flystick3 only)	Description
<i>sync groups</i>	Configure your active Flystick3 (discontinued) to send out IR flashes for one or more syncgroups (syncgroup #1, syncgroups #1 and #2, ...; default = syncgroup #1).
<i>flash intensity</i>	Change the flash intensity of the active target (discontinued) of the Flystick3 (default = 3) by moving the slider.

Table 5.4: Flystick settings - Description of the checkboxes and options

MultiUser option The MultiUser option is an enhancement especially for VR/AR applications when working with more than one Flystick. Up to ten users can be equipped with a Flystick and a head target (usually mounted on glasses). The software **DTrack2** is able to track them all but only the data pair (Flystick and head target) of one user is available as output data. Switching between the single users can be done by just pressing one of the Flystick buttons.

Depending on how many Flysticks you are using, you have to configure the *number of Flysticks* (max. 20) in *Settings* → *Flystick*. Tick the checkbox '*activate MultiUser function*'. If you want to use a Flystick2 and a head target as data pair then you have to tick the checkbox '*use head targets*' as well. Please refer to chapter B on page 155 for more details on the output format.

5.3.2.1 Flystick Calibration

After assigning the Flystick to the ART radio transceiver, close the *Flystick Settings* dialogue and select *Calibration* → *Body calibration*.

In the appearing dialogue the body to be selected is named '*Flystick body 01*'. Please

define the orientation of the body coordinate system relative to the body (default setting is 'due to body'). Make sure that all markers of the Flystick2 are seen by the cameras using the *Monitor 2DOF display* which appears in the background.

Press *Calibrate* and the calibration starts within 5 seconds. Please refer to chapter 7.6.5.2 on page 116 for more information concerning body calibration procedure.

5.3.2.2 Flystick Output settings

The last step is to define where the Flystick data has to be sent to. In *DTrack2* frontend software, select *Settings* → *Output*. You can either select *this computer* (= remote PC) or enter an IP address of another computer you want to send data to. By ticking the checkbox '6df2' you can define the Flystick data to be transmitted.

Please refer to chapter 7.5.7 on page 100 for more details.

Press *Start* to start the measurement. In order to see the tracking data you have to enable the Flystick display by clicking *Display* → *Flystick*. Please refer to chapter 7.3.3 on page 81 for details.

5.4 Measurement Tool

Introduction The *ART* Measurement Tool is a pointing device for measurement or medical applications. In this specialized field it is very important to measure positions of points in high accuracy. For that reason the Measurement Tool is equipped with a measurement tip. The position of the tip can be measured with the optical tracking system.



Figure 5.11: Measurement Tool

Description The Measurement Tool is an add-on to the **ART** tracking system and is integrated into **DTrack2** by entering a license code, which can be purchased from **ART**. Please refer to chapter 7.4.1 on page 86 for details how to upgrade your system.

The pointing device carries a target that was developed to get optimal tracking quality for the use with two IR cameras. You will get the best measurement results, when the pointing device is facing the cameras as shown in figure 5.11 on page 47 (i.e. markers have to be oriented towards the cameras). Typically, the position of the tool's tip is measured in the **DTrack2** room coordinate system which was fixed during room calibration.

Optionally, the **ART** Measurement Tool can calculate the position relative to a "reference body". Then, the Measurement Tool is measuring distances to the origin of the reference body coordinate system, and not to the origin which was defined during room calibration.

Data output The output data consists of:

- position and orientation of the tool's tip,
- number of the Measurement Tool ,
- rotation matrix of the target.

Please refer to chapter B on page 155 for more information about the format of the output data.

5.4.1 Measurement Tool Configuration

First, you have to define how many Measurement Tools you want to use. Therefore, please go to *Settings* → *Measurement Tool* (see figure 5.12 on page 49).

In this dialogue you can define the '*number of Measurement Tools*' as well as '*number of references*'. Additionally several other parameters can be changed to suit your application.

References If you are working with a reference body you may assign it to a specific '*Measurement Tool ID*':

- mark the respective Measurement Tool ,
- mark the reference body and
- press *Select*.

Repeat these steps if you want to assign references to other Measurement Tools .

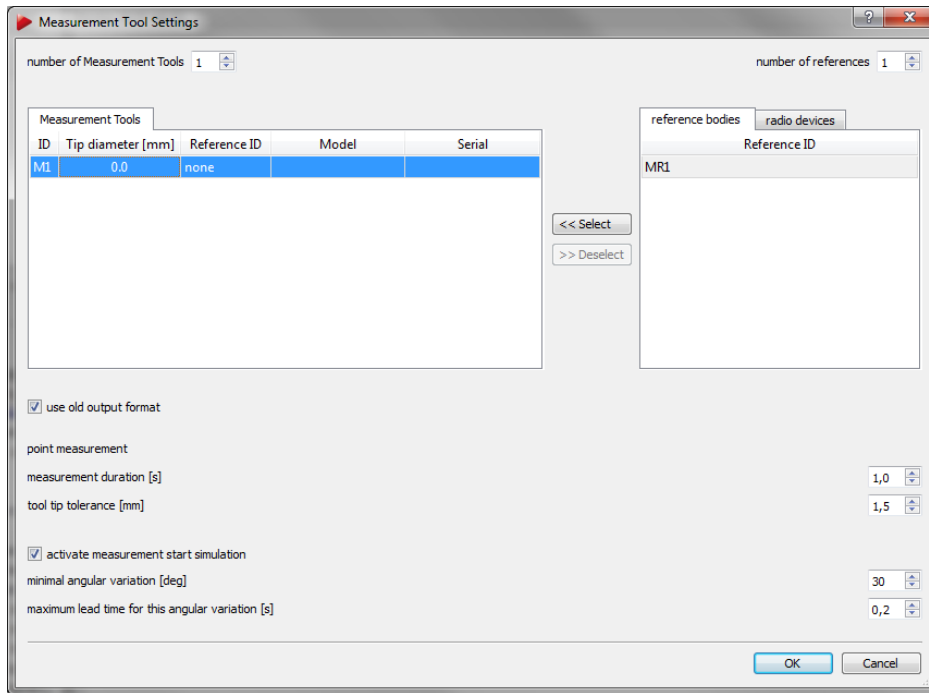

Figure 5.12: Measurement Tool Settings

Control	Description
<i>number of Measurement Tools</i>	configure the number of devices to be used
<i>number of references</i>	configure the number of reference bodies to be used
<i>use old output format</i>	configure legacy output format (refer to chapter B.2.9 on page 168)
<i>measurement duration [s]</i>	configure the time to perform a measurement with the Measurement Tool (valid range: 0.2 - 10.0 sec)
<i>tool tip tolerance [mm]</i>	specify the range within which the tip is assumed to be static (valid range: 0.1 - 5.0 mm)
<i>activate measurement start simulation</i>	activate the gesture detection and enable the respective controls
<i>minimal angular variation [deg]</i>	specify the minimum angle that the Measurement Tool has to be tilted over to start a measurement (valid range: 10° - 120°)
<i>maximum lead time for this angular variation [s]</i>	waiting time before the measurement start after gesture detection

Table 5.5: Measurement Tool settings

Measurement Duration It is possible to define the duration of a point measurement. A compromise has to be found between the amount of data collected and the convenience of holding the measurement tool. Enter the value in seconds in the field *measurement duration [s]*.

Tool Tip Tolerance The tracking system will take measurements up to a defined jitter in millimeter around the tool tip. Configure this tolerance to suit your application. Enter the value in millimeters in *tool tip tolerance [mm]*.

Start Simulation In certain applications and use cases it might be more convenient to start the measurement by a gesture rather than pressing a button on your PC. Tick the checkbox *activate measurement start simulation* to enable the gesture detection. The gesture is simply tilting the the Measurement Tool along the tip axis similar to waving. You can configure the minimum angle of tilt that is necessary to detect the gesture. Enter the value in °[deg] in the field *minimal angular variation [deg]*. Additionally you can specify a waiting time until the measurement starts after detection of the gesture. Specify the time in seconds in the field *maximum lead time for this angular variation [s]*.

5.4.1.1 Measurement Tool Calibration

The calibration of the Measurement Tool is separated into two steps:

1. body calibration of the Measurement Tool and
2. calibration of the tip.

Body Calibration First, please calibrate the Measurement Tool with a standard body calibration (see chapter 7.6.5.2 on page 116) by selecting *Calibration → Body*. In the upcoming dialogue the body to be selected is named '*Measurement Tool body 01*'. Please define the orientation of the body coordinate system relative to the body (default setting is due to body). Make sure that all markers of the Measurement Tool are seen by the cameras using the Monitor 2DOF display which appears in the background.

If you are working with a reference body you would have to calibrate it as well. This is also done by a standard body calibration. Just select the body named '*Measurement Tool reference body 01*'.

Press "Calibrate" and the calibration starts within 5 seconds.

Tip calibration After a successful body calibration, you have to calibrate the tip of the Measurement Tool by selecting *Calibration → Measurement Tool* (see figure 5.13 on page 50) .

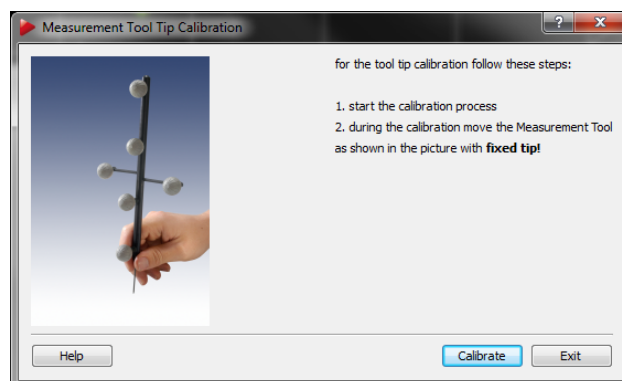

Figure 5.13: Measurement Tool Tip Calibration

Place the Measurement Tool in front of the cameras with the tip fixed at exactly one position (e.g. on a hard surface). Press *Calibrate* to start the calibration process. Gently move the Measurement Tool while tilting it around its tip in all axes (Note: Keep it positioned at exactly one point, i.e. do not lift it from the surface).

DTrack2 will calculate the position of the tip relative to the markers of the Measurement Tool, i.e. the origin of the body coordinate system is transformed into the Measurement Tool's tip.



Note that the progress bar will stop if the pointing device is not moved sufficiently.

If the tip calibration has been successful the result is presented in the dialogue *Measurement Tool Tip Calibration Result*. Please check the information displayed and either 'Accept' or 'Cancel' the tip calibration.

5.4.1.2 Measurement Tool Output settings

Please define where the Measurement Tool data has to be sent to. In *DTrack2* frontend software, select *Settings* → *Output*. You can either select *this computer* (= remote PC) or enter an IP address of another computer you want to send data to. By ticking the checkboxes '6dmt' and '6dmtr' you can define the Measurement Tool data to be transmitted. Please refer to chapter 7.5.7 on page 100 for more details.

Press *Start* to start the measurement. In order to see the tracking data you have to enable the Measurement Tool display by clicking *Display* → *Measurement Tool*. Please refer to chapter 7.3.3 on page 81 for details.

6 Hybrid tracking

With introduction of v2.14.0 *DTrack2* supports advanced sensor fusion of optical and inertial tracking data.

Compatible hybrid targets available from *ART* are communicating with the *DTrack2* system either via wireless 2.4 GHz ISM radio connection or via wired USB connection.

6.1 Wireless hybrid targets

Wireless hybrid targets are distributed together with a wireless transceiver ('Dongle') for communication with the inertial sensors.

6.1.1 Connecting the wireless transceiver

First connect the USB plug of the master dongle to the free USB port of the *SMART-TRACK* using the supplied extension cable. The dongle is activated after rebooting the *SMARTTRACK* or calling *DTrack2* → *Search hardware*.

Now within *DTrack2* go to the menu *Settings* → *Inertial Sensor* and open the *Settings* sub-dialogue (see figure 6.1 on page 52) to check that all attached dongles have been found showing the following

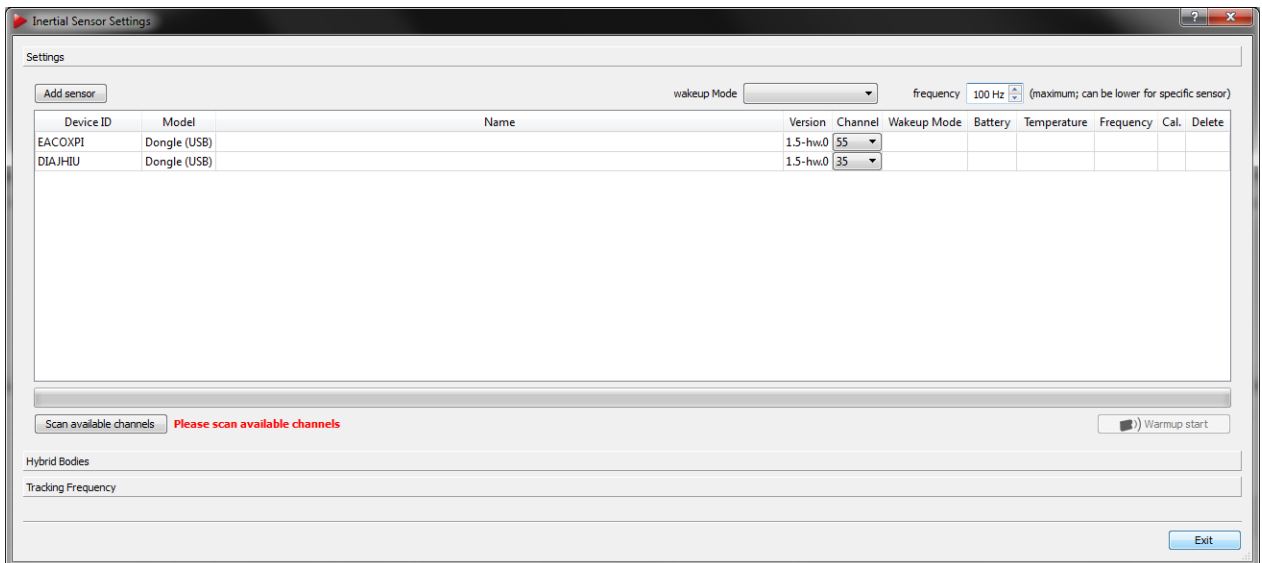

Figure 6.1: Inertial Sensor Settings - Connecting wireless transceivers

Dongle properties:

- Device ID dongle
- Model (Dongle USB)
- Name (n/a)
- Firmware Version
- Currently used radio channel (default: 35 / 55); use the drop-down menu to change the radio channel
- Wake-up mode (n/a)
- Battery level (n/a)
- Temperature (n/a)
- Frequency (n/a)
- Calibration Status (n/a)
- Delete function (n/a)

At this point only dongles should be listed, otherwise check that all previously added sensors show up together with their corresponding dongle. Please refer to figure 6.4 on page 56.

Next scan the available radio channels by pressing *Scan available channels*. After completion the drop-down menu in the column *Channel* will show a list of all available channels for each dongle (see figure 6.2 on page 53). The currently used channel is marked in bold digits, while all channels that are not recommended are greyed out. Additionally *DTrack2* shows recommended channels (marked green).

	2	3	4	5	6	7	8	9	10
11	12	13	14	15	16	17	18	19	20
21	22	23	24	25	26	27	28	29	30
31	32	33	34	35	36	37	38	39	40
41	42	43	44	45	46	47	48	49	50
51	52	53	54	55	56	57	58	59	60
61	62	63	64	65	66	67	68	69	70
71	72	73	74	75	76	77	78	79	80
81									

Figure 6.2: Dongle Configuration - Selection of a radio channel

Please select an appropriate channel for each dongle now. The selected dongle will change its channel accordingly and likewise all assigned sensors. Do not set both dongles to the same channel or on occupied frequencies from other devices in range.



The default channels for all dongles and sensors are 35 and 55 (out of 80). In case these frequencies are already occupied by other devices in range (e.g. WLAN), connection problems may occur. **ART** recommends to scan for available channels and to select free channels accordingly. A minimum distance of 10 channels is mandatory between dongles, and recommended from otherwise unavailable channels for optimum connectivity.

6.1.2 Connecting the wireless inertial sensors

This needs to be done initially - in case the sensors are already connected please skip this step.

All **ART** pre-calibrated targets are delivered with their corresponding optical target geometries stored inside the inertial sensor. Thus when adding the recognized inertial sensors, all corresponding target geometries are automatically added to the tab 'standard bodies' in the menu *Body Administration* (Shortcut:F8) and the sub-dialogue *Hybrid Bodies* of the menu *Inertial Sensor Settings* respectively.



Please ensure that all sensors have been charged or alternatively attach the sensors to the supplied charging hub prior to the following steps.

Turning on/off wireless inertial sensors Turn on all sensors by pressing their corresponding buttons. The status LED will turn green.

All inertial sensors are turned to stand-by mode after a pre-defined idle time, which corresponds to the selected wake-up mode.

via: radio (idle time: 1 min.), i.e. the sensors are switched on as soon as they are addressed by the **SMARTTRACK**.

via: tapping (idle time: 3 min., older sensors only), i.e. the sensors are switched on by tapping on the sensors with your fingertip or tapping the sensors on a hard surface (e.g. table).

via: USB/button (idle time: 10 min.), i.e. the sensors are switched on by pressing the button on the sensor for 3-4 seconds or by connecting them to the supplied charging hub.



For optimal battery life, **ART** recommends to switch all sensors to wake-up mode "USB/button" when not in use for a longer period of time.

6.1.2.1 Adding wireless inertial sensors

In the menu *Settings* → *Inertial Sensor*, press *Add sensor* to identify and connect all inertial sensors in range (see figure 6.1 on page 52).

In the upcoming dialogue (see figure 6.3 on page 55) you should find the *Scan mode* being 'USB'. Please change the mode to 'default channels' using the adjacent selection box.

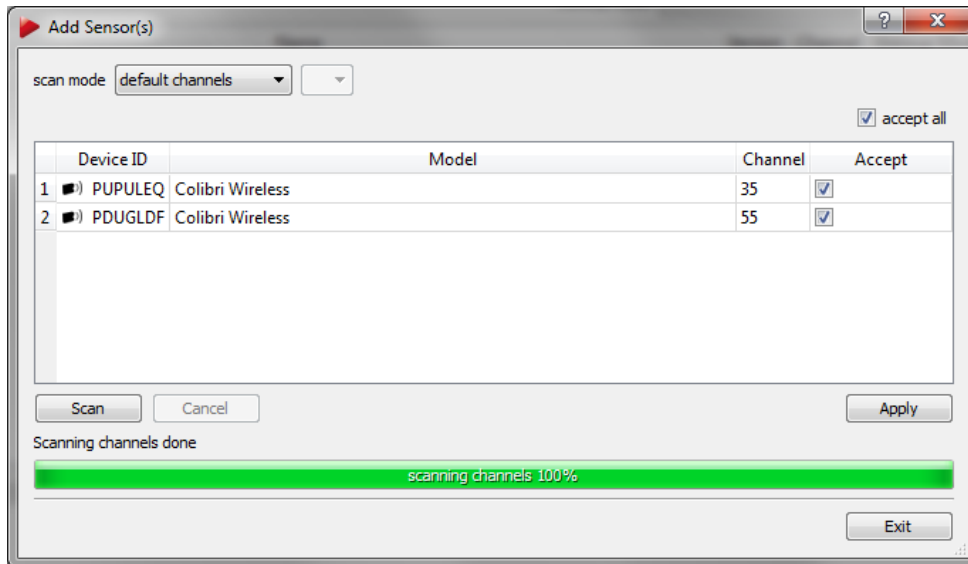

Figure 6.3: Adding wireless inertial sensors

In this mode *DTrack2* will search for the sensors on default channels 35 and 55, even if the current channel of dongles / sensors has been set differently. In case the dongles / sensor channels have been set manually, please change the scan mode to '*single*' and select the corresponding channels in the adjacent selection box.

Press *Scan* and the system will identify all sensors in range running on the specified channels. Tick the checkboxes of all sensors to be added to the configuration in the column *Accept* or add all sensors by ticking '*accept all*'. Then press *Apply* and exit this dialogue.



If you cannot remember the current radio channel of your sensors, you can either choose '*all*' to scan all channels (from 1 to 80, note: this takes some time) or identify the sensors via wired connection. To this end connect all sensors to the *SMARTTRACK* via a USB charging cable and select the scan mode '*USB*'. All attached sensors will be listed together with their corresponding channel.



Take care that all inertial sensors are assigned to the radio channel of the attached dongle; otherwise such a sensor cannot be used during measurement. Also take care that max. 10 sensors are assigned to the dongle.

After adding the sensors the dialogue *Inertial Sensor Settings* (see figure 6.4 on 56) now shows the available dongle and its assigned sensors with the following

sensor properties:

- Device ID sensor + wireless icon (e.g. PUPULEQ)
- Model (e.g. Colibri Wireless)
- Name (target name pre-calibrated or user-defined)
- Firmware Version

6 Hybrid tracking

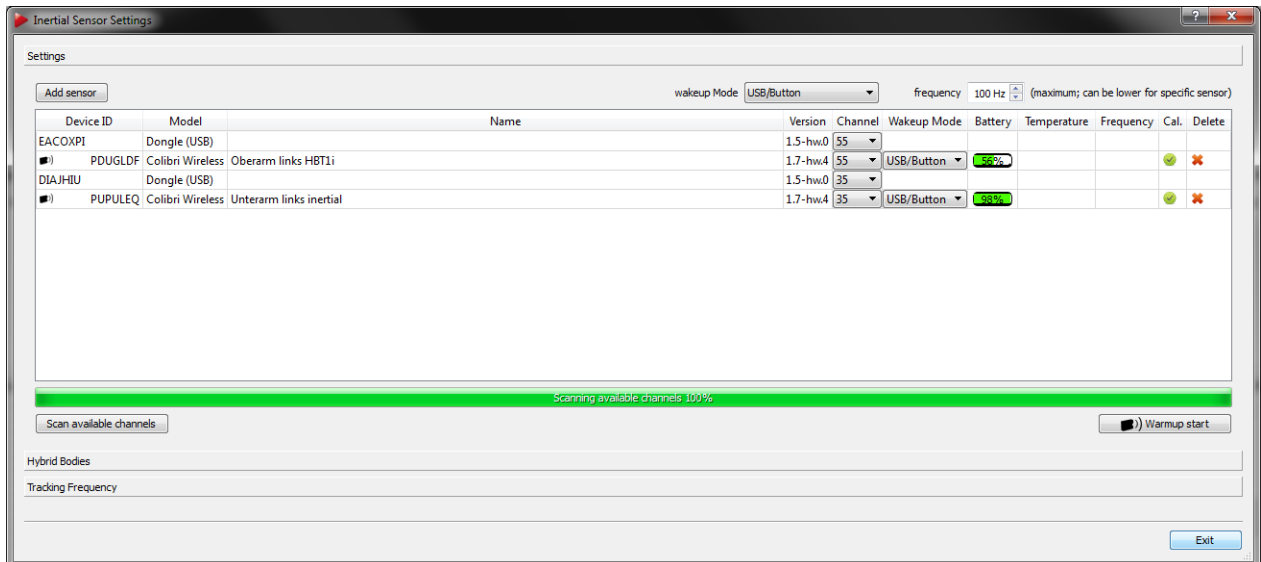

Figure 6.4: Inertial Sensor Settings - Wireless transceivers and sensors added

- Currently used radio channel (default: 35 / 55); use the drop-down menu to change the radio channel of the corresponding dongle
- Wake-up mode (radio, tapping, USB/button)
- Battery level (%)
- Temperature (°C, only after measurement)
- Current tracking frequency (Hz, only after measurement)
- Calibration Status (*not calibrated, optical only, fully calibrated*)
- Delete function



The temperature values between single inertial sensors may vary. The operating temperature is reached as soon as there are no more temperature changes inside the sensors indicated by a green status bar. It is not dependent on the absolute temperature value.

Tracking frequency Finally please check the maximum tracking frequency the inertial sensors are operating at (default for wireless sensors: 100 Hz). Use the spinbox in the upper right corner of the window to select a different value, if necessary.

Selecting the pulse generating source Please refer to chapter 6.2.5 on page 65 for further details.



It is NOT recommended to select a wireless inertial sensor as pulse generator due to the nature of the connection (i.e. high latencies and timing jitter). Therefore change the default settings in the menu *Settings* → *Tracking only when necessary*.

6.1.3 Calibration of custom wireless hybrid targets

Custom wireless hybrid targets will show up as 'not calibrated' in the column *Calibration* under the tab 'standard bodies' in the menu *Body Administration* (Shortcut:F8) or in the sub-dialogue *Hybrid Bodies* of the menu *Inertial Sensor Settings*. Therefore a multi-step calibration procedure for each body has to be performed analogue to wired hybrid targets. Please refer to chapter 6.2 on page 57.



ART delivers pre-calibrated wireless targets, i.e. both the optical target geometry as well as the hybrid body calibration are stored directly on the sensor. Unless the hybrid targets are disassembled or become damaged, it is sufficient to identify and add all sensors using the menu *Settings* → *Inertial Sensor* → *Add Sensors*. There is no need to (re-)assign the inertial sensors on pre-calibrated targets or to calibrate the targets manually.



Reassignment or disassociation of inertial sensors and pre-calibrated optical targets will render the corresponding bodies useless. Therefore enter the sub-dialogue *Inertial Sensor Settings* → *Hybrid Bodies* only when necessary.

6.2 Wired hybrid targets

Within *DTrack2* go to the menu *Settings* → *Inertial Sensor* → *Hybrid Bodies* (see figure 6.8 on 60) and activate the desired amount of bodies. Next assign suitable names by double-clicking the corresponding field *Name* from row '1...n' under *selected body*. Now a multi-step calibration procedure for each body has to be performed:

1. A standard optical body calibration needs to be carried out. Alternatively load a body calibration from a file. Start by pressing the button *Calibration*. Please refer to 7.6.5.2 on 116 for more details.
2. An inertial sensor has to be added and then assigned to an optical target. Please refer to chapters 6.2.1 on page 58 and 6.2.2 on page 60 respectively for further information.
3. A hybrid body calibration has to be performed to align the inertial sensor with its corresponding optical target by pressing the button *Hybrid Body Calibration*. During this hand-eye calibration process the relative orientation of the two coordinate systems is determined. Please refer to chapter 6.2.3 on page 61.
4. An inertial sensor calibration needs to be applied to compensate drift from the inertial sensor. Start by pressing the button *Inertial Sensor Calibration*. Please refer to chapter 6.2.4 on page 63.

Repeat all steps for each hybrid target and finally set the pulse generating source that drives the tracking frequency according to your application's requirements. Please refer to chapter 6.2.5 on page 65.



Wired hybrid targets for use with e.g. HMDs are not delivered pre-calibrated, simply due to the fact that mechanical changes during assembly on top of the customer's gear would render any pre-calibration useless.

6.2.1 Connecting the wired inertial sensor

This needs to be done initially - in case the sensor is already available please skip this step.

Within *DTrack2* go to the menu *Settings* → *Inertial Sensor* and open the *Settings* sub-dialogue (see figure 6.5 on page 58).



Never attempt to connect 3-Space wired sensors / hybrid targets to a personal computer or try to access the sensor using software provided by the original manufacturer *Yost Labs*. This may result in irreversible damage of the sensor.



Be sure to use an active (USB 2.0) hub to connect the wired sensor / hybrid target to a *SMARTTRACK*. Otherwise proper function of the sensor cannot be guaranteed.

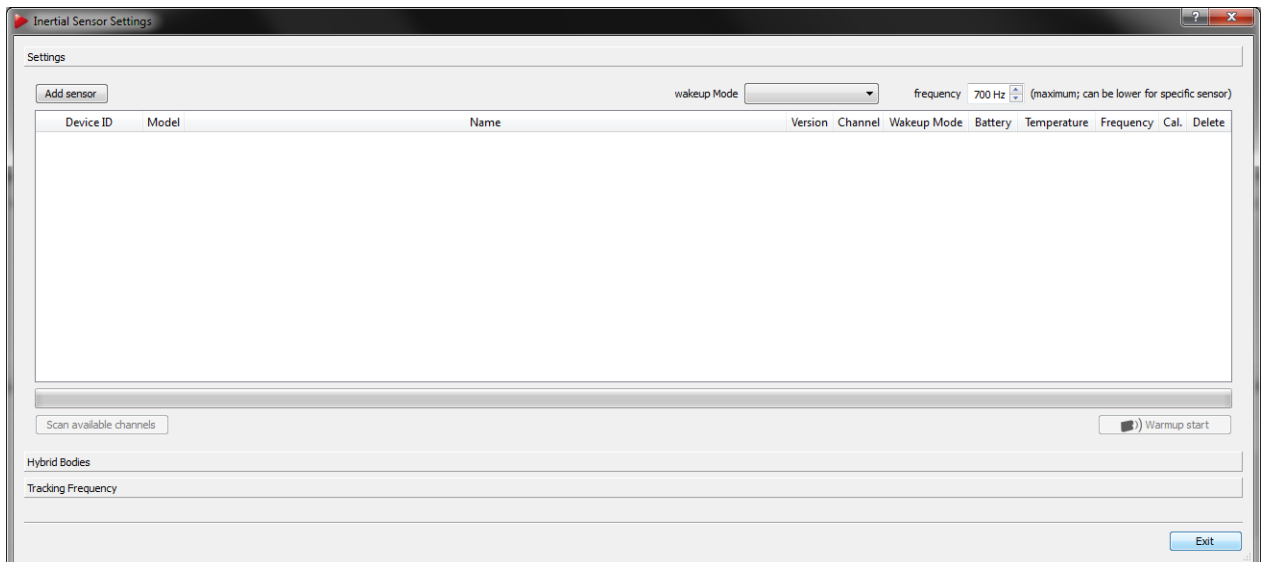

Figure 6.5: Inertial Sensor Settings - No wired inertial sensor connected

6.2.1.1 Adding wired inertial sensor

Please ensure that the sensor has been connected to the *SMARTTRACK*. Then press the button *Add sensor*.

In the upcoming dialogue (see figure 6.6 on page 59) you should find the *Scan mode* being 'USB'.

Press *Scan* and the system will identify all attached sensors. Tick the checkbox of the sensors to be added to the configuration in the column *Accept* or add all sensors by ticking 'accept all'. Then press *Apply* and exit this dialogue.

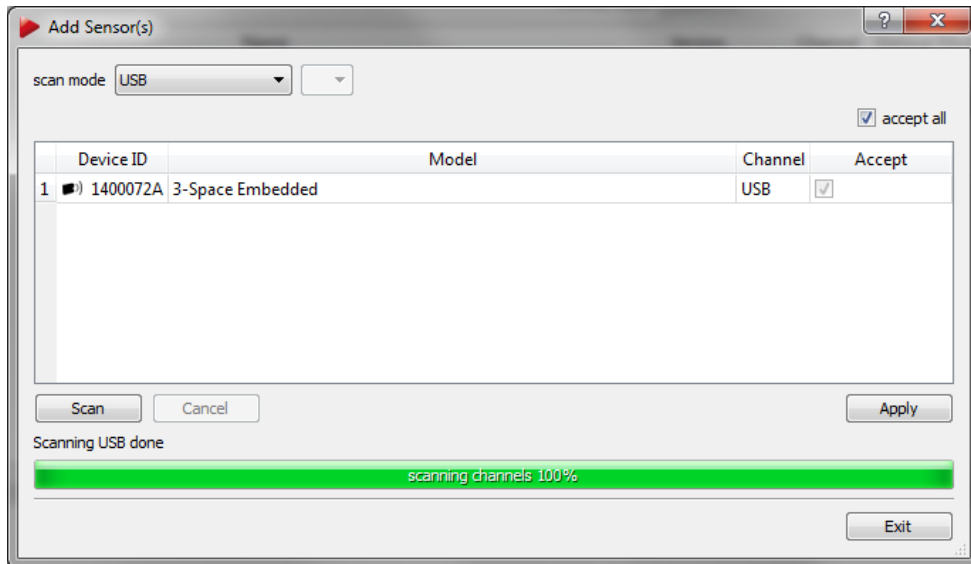

Figure 6.6: Adding wired inertial sensor

The dialogue *Inertial Sensor Settings* (see figure 6.7 on page 59) now shows all available sensors with the following properties:

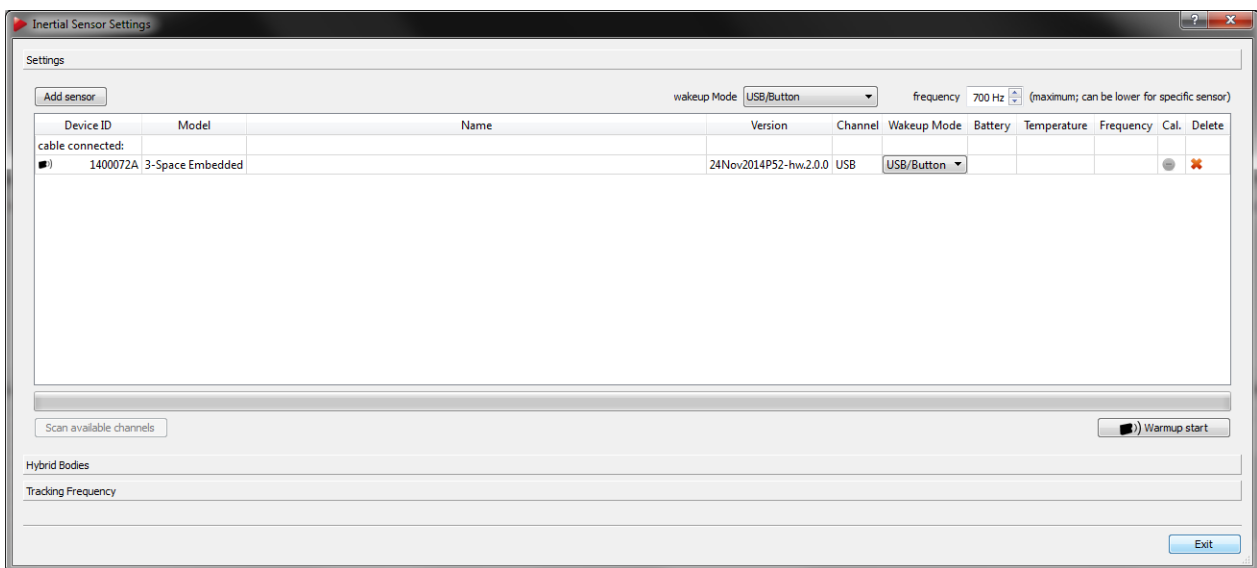

Figure 6.7: Inertial Sensor Settings - Wired inertial sensor added

- Device ID
- Model (e.g. 3-Space wired)
- Name (empty unless user-defined)
- Firmware Version
- Currently used channel (USB)

6 Hybrid tracking

- Wake-up mode (n/a)
- Battery level (n/a)
- Temperature (°C, only after measurement)
- Current tracking frequency (Hz, only after measurement)
- Calibration Status (*not calibrated, optical only, fully calibrated*)
- Delete function

Tracking frequency Finally please check the tracking frequency the sensors are operating at (default for wired sensors: 700 Hz). Use the spinbox in the upper right corner of the window to select a different value, if necessary.

6.2.2 Assigning the wired inertial sensor

After adding the inertial sensor it needs to be assigned to an optical target, which has been calibrated beforehand. Change to the sub-dialogue *Hybrid bodies* inside the dialogue *Inertial Sensor Settings* (see figure 6.8 on 60).

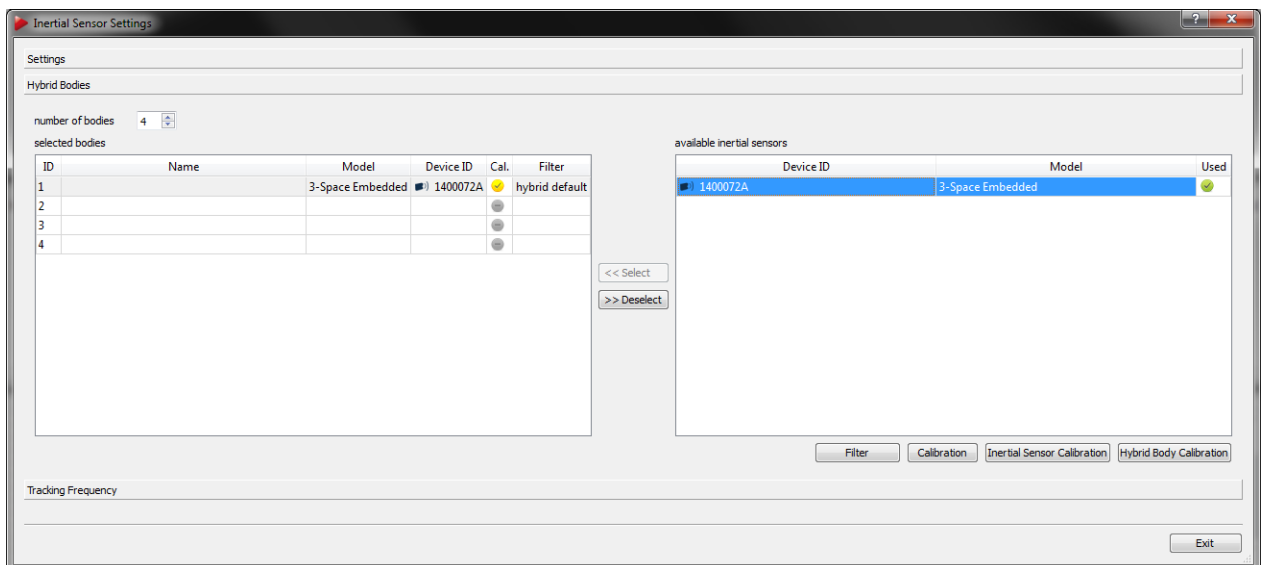

Figure 6.8: Inertial Sensor Settings - Hybrid Bodies sub-dialogue

In order to assign an inertial sensor to an optical target follow these steps:

- mark the respective *Body ID* under *selected bodies* by left-clicking
- mark the appropriate entry '*Device ID*' under *available inertial sensors* by left-clicking and
- press *Select*.

You can always delete the assignment by pressing the button *Deselect*. The inertial sensor will be available again for assignment.



If the inertial sensor is already in use a green tick is shown in the column *Used* on the right side of the window.



For each uncalibrated body the 'Name' entry will be empty, while the column *Cal.* will show a *No Entry* sign. Body IDs without corresponding hybrid body calibration are marked with a yellow tick on the corresponding *Body ID* row in the column *Cal.*. A fully calibrated *Body ID* is marked with a green tick.

After assignment the corresponding body is shown on the left side of the window with the following properties (see figure 6.8 on 60):

- Body ID
- Name (empty unless user-defined)
- Model (e.g. 3-Space wired)
- Device ID (of the assigned inertial sensor)
- Calibration Status (*not calibrated*, *optical only*, *fully calibrated*)
- Filter Status (please refer to chapter 7.5.6.1 on page 97)

Additionally all attached inertial sensors are listed on the right side together with:

- Device ID
- Model (e.g. 3-Space wired)
- Assignment Status (*not used*, *Used*)



In order to identify the inertial sensor and to assign it to the corresponding *Body ID* please double-check the serial number on top of the sensor and compare it to the entry in column *Device ID*.

6.2.3 Hybrid Body Calibration

After assigning an inertial sensor, select the respective *Body ID* under *selected bodies* and press the button *Hybrid Body Calibration* (see figure 6.8 on 60).

In the appearing window (see figure 6.9 on page 62) verify the target by its corresponding 'name' and 'bodyID' from the adjacent drop-down menu. Also double-check the 'Device ID' of the inertial sensor for correspondence with the selected optical target. Then press *Calibrate*. During the following calibration process the target has to be tilted with moderate speed around all axes of the inertial sensor (please refer to the animation in the dialogue see figure 6.9 on page 62). After the countdown disappears the upcoming dialogue will show the status of the calibration via a progress bar (see figure 6.10 on page 62.)

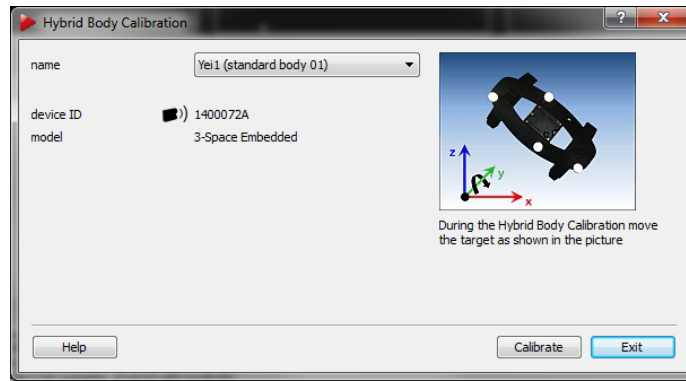

Figure 6.9: Hybrid Body Calibration

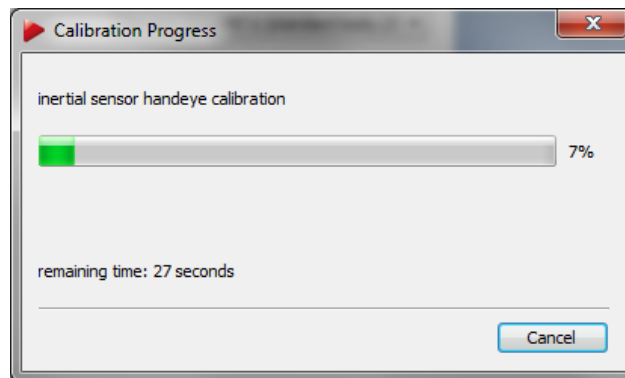

Figure 6.10: Hybrid Body Calibration - Progress Bar

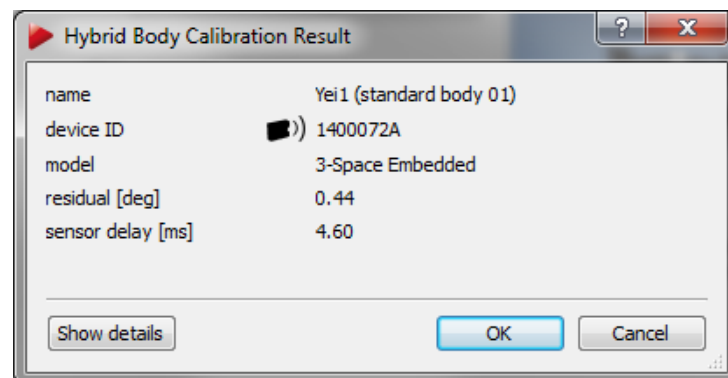

Figure 6.11: Hybrid Body Calibration Result

In the upcoming result window (see figure 6.11 on page 62) the residual of the calibration and the sensor delay of the inertial tracking data is displayed.



The residual specifies how well the rotational data from the inertial sensor matches the optical tracking data. Thus it is a measure of the accuracy of the hybrid body calibration. Values up to 1° are ideal, while anything less than 3° is still acceptable.



The sensor delay specifies the latency of the inertial data compared to real-time. This is sensor specific and dependent on the type of connection (wired / wireless). Values up to 5 ms are ideal for HMD applications.

You can accept the calibration by pressing *OK* to return to the *Hybrid Body Calibration*. Press *Exit* to return to the *Hybrid Bodies* sub-dialogue. Now, the sensor should show a green tick in the column *Calibration* under *selected bodies* on the left side of the window.

Show details You can display the result of the hybrid body calibration as a rotation matrix by pressing the button *Show details*.

6.2.4 Inertial Sensor Calibration

After successful calibration of all hybrid bodies, a drift correction for all inertial sensors should be measured and applied. To this end, all sensors have to be warmed-up beforehand. Please refer to chapter 6.2.4.1 on page 65 for more details.

To start the inertial sensor calibration, select *Inertial Sensor Calibration* from the sub-dialogue *Hybrid bodies* inside the dialogue *Inertial Sensor Settings* (see figure 6.8 on 60). The upcoming window shows a list of all available hybrid targets, i.e. bodies with successful optical calibration and assigned inertial sensor (see figure 6.12 on page 63).

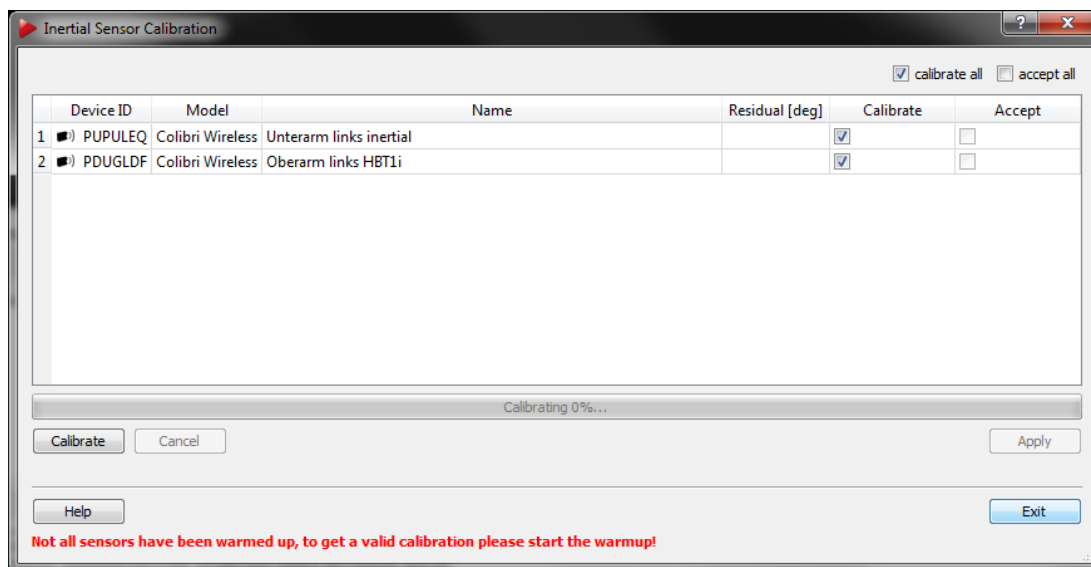

Figure 6.12: Inertial Sensor Calibration

Put the respective sensor inside the tracking volume on a level surface (pre-condition: a successful Hybrid Body Calibration for each inertial sensor). Tick the checkboxes in the column *Calibrate* of all sensors to be calibrated and press *Calibrate*. Do not move or touch it during the following calibration !

In the upcoming result window (see figure 6.13 on page 64 the residual of the drift correction is displayed.

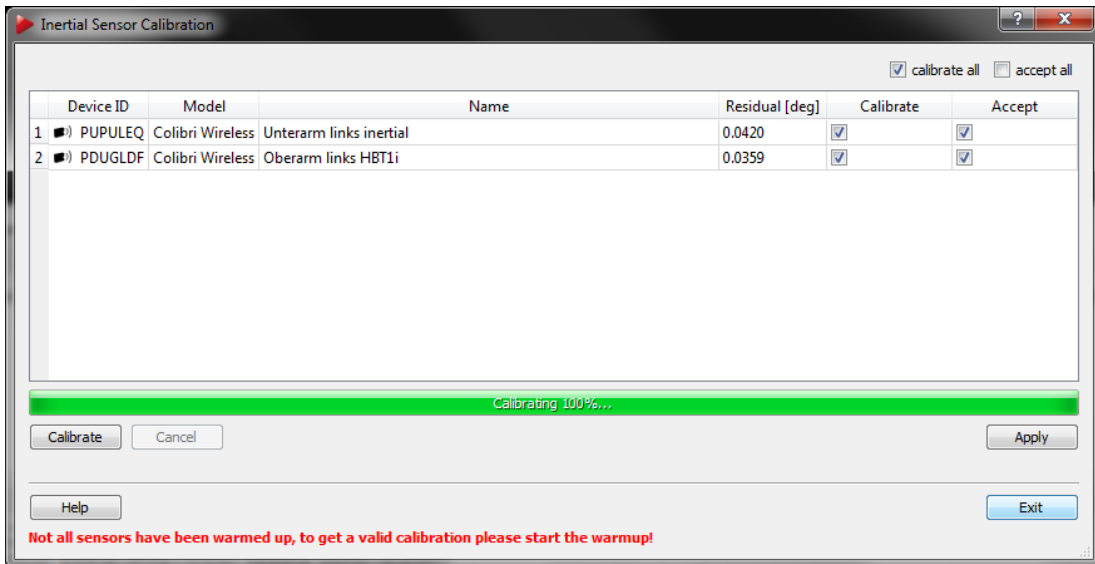

Figure 6.13: Inertial Sensor Calibration - Result Window



The residual specifies the drift correction for the inertial sensor. Values below 0.1° are ideal, while still being acceptable up to 0.2° . Higher values indicate possible movement during the calibration.

When the calibration is done, you can apply the drift correction either to a single sensor by ticking the appropriate checkbox in the column *Accept* or by ticking 'accept all' for all sensors in range. Press *Apply* and exit the dialogue. A list of all successfully calibrated sensors appears (see figure 6.14 on page 64). Press *Exit* to return to the *Inertial Sensor Calibration* window. Return to the *Inertial Sensor Settings* → *Hybrid Bodies* subdialogue by pressing *Exit* once again.

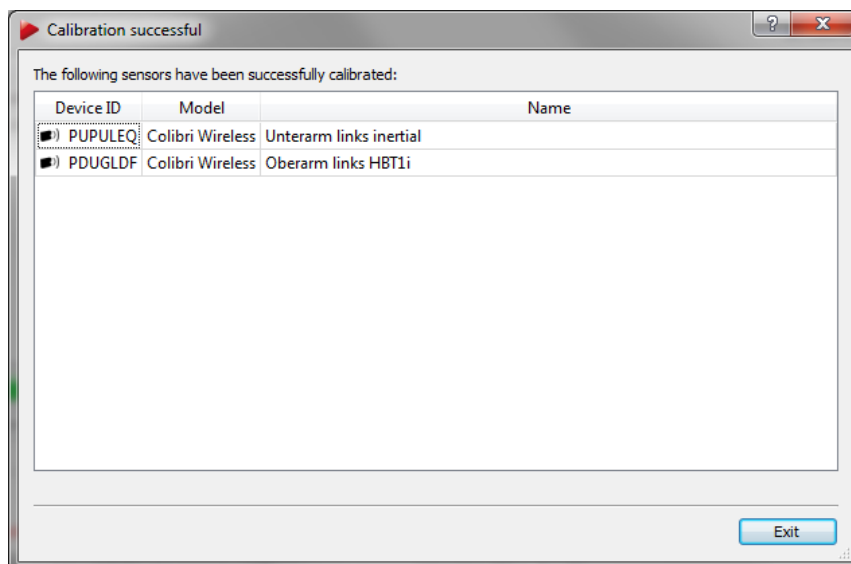



Figure 6.14: Inertial Sensor Calibration - Result Window Successful



After the Inertial Sensor Calibration has been performed and applied its result is stored directly on the sensor for future use.

6.2.4.1 Warm-up of inertial sensors

To start up the procedure simply press the button *Warmup start* in the dialogue *Inertial Sensor Settings* (see figure 6.7 on page 59) or in the toolbar of **DTrack2** frontend (refer to chapter 7.3.2 on page 80) and leave the process running for about 5-10 minutes. The progress bar will stop at 100% (progress bar turns green) even though the warming up of the sensors continues. This shall guarantee that the sensors work continuously and do not cool down until the calibration takes place.

-  **Please ensure that all sensors have been charged prior to any calibration process.**
-  **Please perform inertial sensor calibrations with warmed-up sensors at constant ambient temperature prior and during the calibration for optimum tracking performance.**

6.2.5 Selecting the pulse generating source

There are several independent pulse generating sources available in a hybrid tracking setup (i.e. combined optical & inertial tracking). Therefore it is necessary to select the appropriate one that drives the tracking frequency.

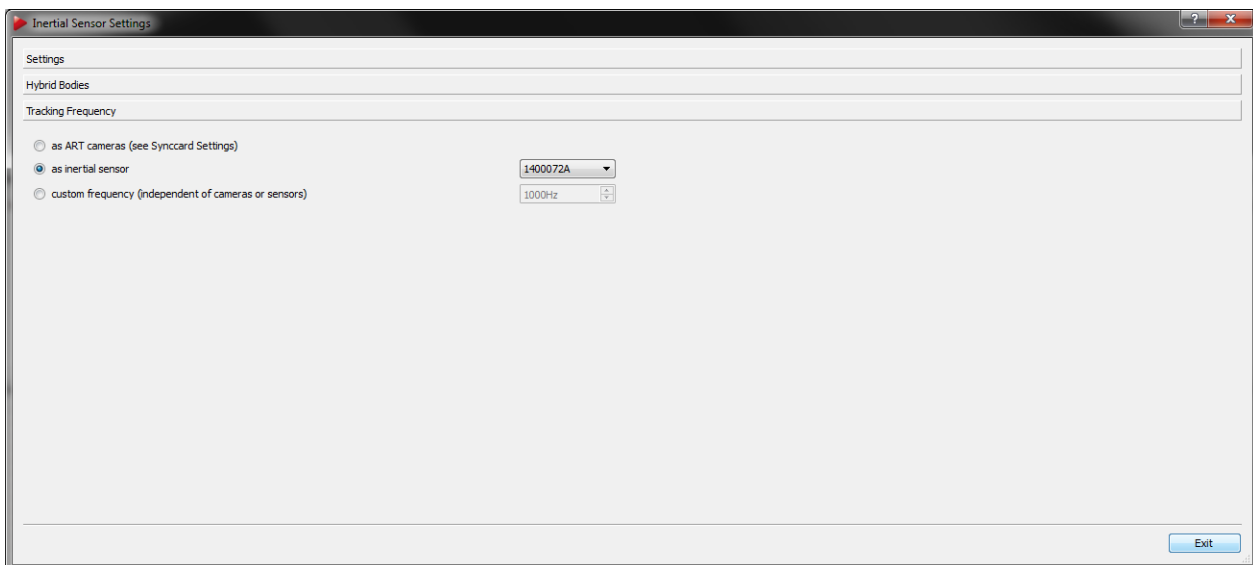

Figure 6.15: Hybrid Tracking Settings - Inertial Sensors available (license necessary)

You can switch between the following sources by ticking the corresponding radio button in the subdialogue *Inertial Sensor Setting Tracking frequency*:

- 'as ART cameras': The **SMARTTRACK** synccard is used. The tracking frequency is set according to the *Synccard Settings* menu. Please refer to the corresponding chapters 7.5.2 on page 91.
- 'as inertial sensor': An inertial sensor is used (only available, if attached). If using multiple inertial sensors use the adjacent drop-down menu to select the appropriate

6 Hybrid tracking

one. The tracking frequency is set according to the *Inertial Sensor Settings* menu. Please refer to the corresponding chapter 6.2.1.1 on page 58.

- '*custom frequency*': An internal source is used providing a custom frequency (only available with inertial license). Use the adjacent spinbox in a range from 10 to 400 Hz.



Selecting a custom frequency higher than the tracking frequency provided by the inertial sensors (e.g. 700 Hz for 3-Space wired inertial sensors) could lead to minor tracking quality.



Keep in mind that '*send data divisor*' in menu *Output Settings* is also affecting the resulting data output frequency. Please refer to chapter 7.5.7 on page 100 for further information.



It is NOT recommended to select a wireless inertial sensor as pulse generator due to the nature of the connection (i.e. high latencies and timing jitter). Therefore enter the menu *Settings* → *Tracking* only if necessary.

7 DTrack2 frontend software

The **SMARTTRACK** is an integrated tracking system. Thus for the sake of readability the **SMARTTRACK** is referred to as 'Controller' in the following sections.

The software **DTrack2** is intended to access any **ART** controller via ethernet and runs on a remote PC (Windows or Linux). **DTrack2** itself is delivered via USB pen-drive. The latest version can be downloaded from our Download Center at <http://www.ar-tracking.com/support/>

 **DTrack2 supports the SMARTTRACK starting with version v2.7.0. Please do not use it with older versions of the DTrack2 frontend software.**

7.1 Getting started

Please refer to chapter A.3 on page 153 for more information on supported operating systems.

7.1.1 Installation guide (Windows)

Run the installation executable "**DTrack2_v2.x.x_win32_install.exe**" and the installation wizard of **DTrack2** starts.

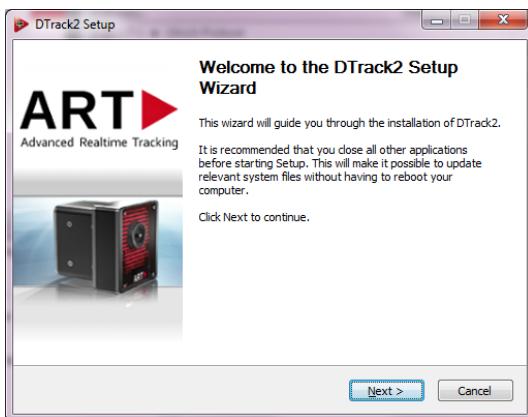

Click *Next* to continue and to start the installation process for **ART DTrack2** software. Administrator rights are not necessary.

7 *DTrack2* frontend software

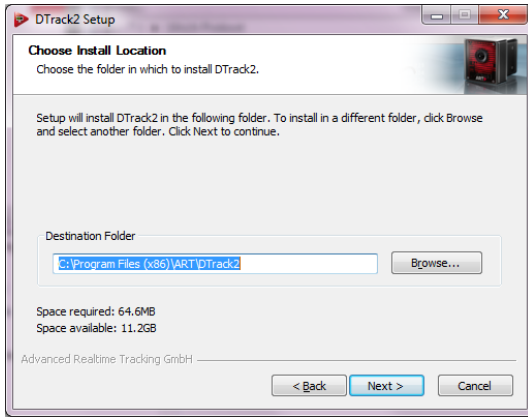

Now, please choose the destination folder in which you want to install *DTrack2* .

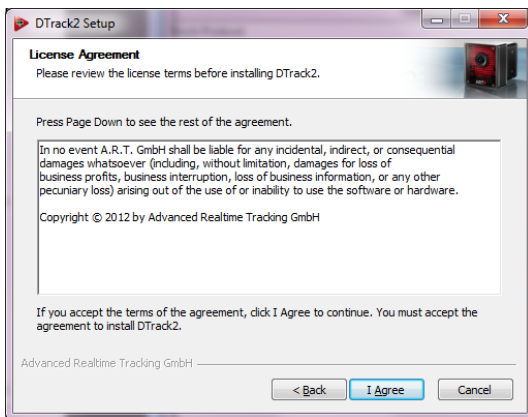

Please read the license terms carefully and press *I Agree* if you agree indeed. A new window shows the installation progress.

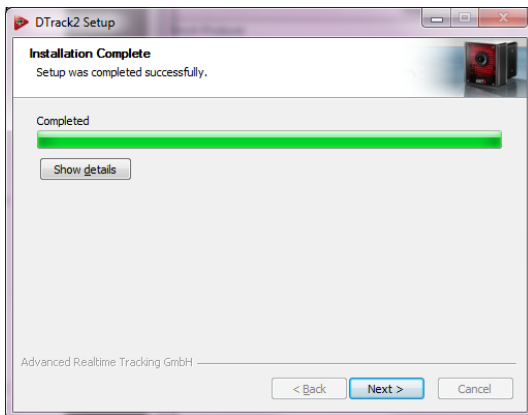

The installation of the *DTrack2* software is complete now. *DTrack2* has been installed on your computer. Click *Next*.

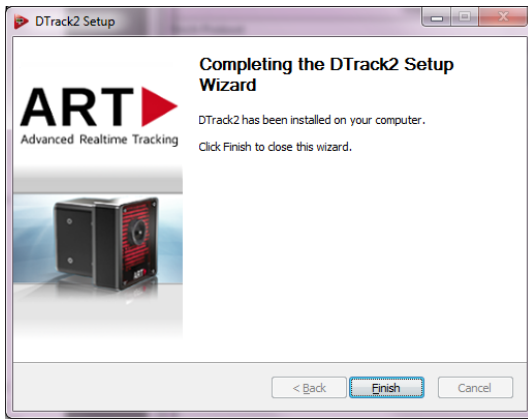

Press *Finish* to complete the *DTrack2* setup wizard. Now, you can use *DTrack2* .

7.1.2 Installation guide (Linux)

The software (32-bit and 64-bit package available) is packed in an archive. (*DTrack2_v2.x.x_linux32.tar.gz*) You do not need to have administrator rights to extract all files to a user-defined folder. In a shell, change to the user-defined folder and type in the command `tar xvf DTrack2_v2.x.x_linux32.tar.gz` in order to extract the files. For ease of use, you may create a shortcut on the desktop.

DTrack2 can be started with the command `./DTrack2`.

7.1.3 Software update

The latest *DTrack2* software is always available from our Download Center at <http://www.ar-tracking.com/support/>. For the installation of the frontend update, please proceed as mentioned before in chapters 7.1.1 and 7.1.2.

After installing *DTrack2* on the host PC the controller can be updated after establishing a connection with the new frontend. Please refer to chapter 7.8.1 on page 127.

7.1.4 Start *DTrack2* frontend software

When you start up *DTrack2* on the remote PC you will see the following splash screen (see figure 7.1 on page 70).

Using the mouse or shortcuts (2 = down, 4 = left, 6 = right, 8 = up) you can move around the splash screen window, e.g. to a secondary screen. The position of the window is then saved and will be used at the next start-up.

7.1.5 *DTrack2* command line parameters

The following parameters (refer to table 7.1 on page 70 may be added to the command line (i.e. *DTrack2* icon → properties → shortcut → target) when starting the *DTrack2* frontend.

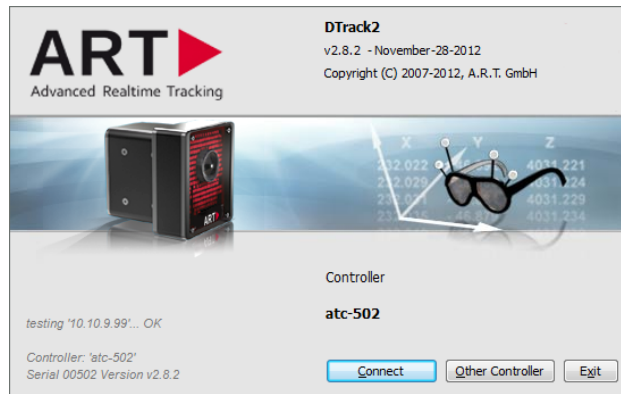

Figure 7.1: Welcome screen of *DTrack2*

Command line parameter	Description
-directstart	Connect with the last used controller (can be combined with -measure)
-help	Shows a window with these command line parameters and additional examples
-host <name or IP>	Connect with given controller (by name or IP number) (can be combined with -measure)
-measure	After connecting, start measurement
-wakeup	Wake up the last connected controller (can be combined with -directstart and -measure)
-wakeup <MAC>	Wake up controller with given MAC address (can be combined with -host and -measure)

Table 7.1: Command line parameters

7.2 Connecting to the *SMARTTRACK*

When you start up *DTrack2* for the first time, you will need to specify the default controller. Please jump to chapter 7.2.1 on page 71.

After the first run of *DTrack2* your controller is still known by the frontend and it will automatically search for it. The welcome screen will show the host-name, the last known IP-address and the status of your controller (i.e. 'testing IP-address OK' and 'resolving host-name OK', see figure 7.1 on page 70). If you would like to connect to the controller shown at this point, just press *Connect*. The main window will open (refer to 7.3 on page 78). In case you would like to choose a different controller, press *Other Controller*.

To wake up your controller from standby-mode (Wake on LAN), please refer to 7.2.3 on page 72.

In any other case (i.e. 'testing IP-address unsuccessful' and 'resolving host-name unsuccessful' and Wake on LAN unsuccessful), please refer to chapter 8 on page 130.

7.2.1 Other Controller (1st run after installation)

Whenever you would like to select a different controller than the default or last known (done automatically after installation and first run of **DTrack2**) the splash screen is skipped and a separate window will be opened (see figure 7.2 a on page 71). The radio button will be ticked at position *Specific Controller*. Depending on your type of connection (see 4.8 on page 35) you can now either scan your LAN (DHCP-service necessary) for available controllers or specify the IP-address or host-name of your controller directly.

Specific controller In case of LANs without a DHCP server or via direct connection to your remote PC (see 4.8 on page 35) you may specify the IP-address of your controller by entering it in line *hostname or IP address*. To connect press *Connect*. In order to find out the IP address of your controller please refer to chapter 7.2.4 on page 73.

Scan LAN To scan your LAN simply select *Scan* followed by pressing *Update list*. You will see a list of all controllers in your network. Controllers set in grey are used by other remote PCs in your network (→ IP address listed at the bottom of the welcome screen), whereas available controllers for connection are set in black. If not, please refer to chapter 8 on page 130. You can easily identify your controller by comparing the serial number (e.g. smarttrack-0432 listed in column *Serial*) with the corresponding one on its label (back of the **SMARTTRACK**, refer to 4.1 on page 26). You can also sort the list by host-name *Name* or IP-addresses *IP*. Select the appropriate entry of your controller and press *Connect*.



If the Controller is not connected via an ethernet cable or no DHCP server is running, it will use its fall-back IP address (IP 192.168.0.1, subnet mask 255.255.255.0)

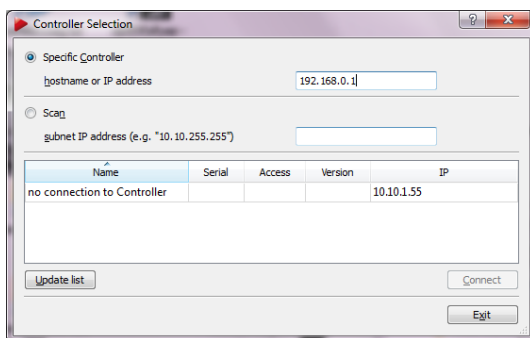

(a) specific controller

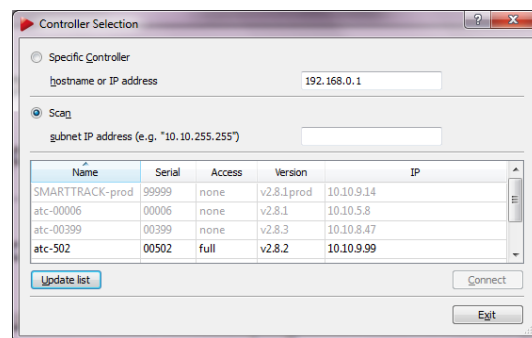

(b) scan the network

Figure 7.2: Controller Selection

7.2.2 Setting a static IP address inside **DTrack2**

If necessary you can set your controller to a static IP address using the following steps:

7 *DTrack2* frontend software

- start up *DTrack2* and connect to your controller by pressing *Connect*
- select the menu *Settings* → *Controller* (see figure 7.19 on page 102)
- untick the checkbox *DHCP client*
- enter *IP address* and *subnet mask*
- optionally, enter *gateway* and *nameserver*
- reboot the controller for the changes to take effect



Please note that these settings are not part of your personal configuration. Changes in this menu will affect all users of your controller! Your controller may become unreachable with wrong IP settings! Refer to chapter 7.2.4 on page 73).

In case you need to specify a static IP address without using the frontend (e.g. installation on network without DHCP service available) please refer to chapter 7.2.4 on page 73 instead.

7.2.3 Wake On LAN

The controller is capable of Wake On LAN (WOL) when powered down in standby mode by the user (*DTrack2* → *Controller standby*).

There are two options for waking up the controller remotely:

1. you may use *DTrack2* or
2. use a separate tool (Windows: WOL program; Linux: console-based command).

Option 1 - WOL via *DTrack2* Start the *DTrack2* frontend software as usual. It will search for the controller but the '*Connect*' button will change its name into '*Wake On LAN*' after a few seconds (see figure 7.3 on page 73).



Please make sure that the controller is still connected to the local network! *DTrack2* cannot wake up the controller if no physical connection between remote PC and controller is established!

Press the '*Wake On LAN*' button and *DTrack2* will try to wake up the controller - this may take up to two minutes as the controller has to boot up (see figure 7.4 on page 73).

If Wake On LAN is successful *DTrack2* will automatically establish the connection with this controller and start the frontend software.

Option 2 - WOL via separate tool You will need the hostname of the controller as well as its MAC address. To get this information, either refer to 7.2.4 on page 73 or en-

Figure 7.3: Welcome screen of *DTrack2* with Wake On LAN option

Figure 7.4: Wake On LAN progress bar

ter *DTrack2* and go to *Settings* → *Controller*. Copy the '*hostname*' and MAC address ('*ethernet-MAC LAN*').

If you are a Windows user you need a separate WOL program to use this feature. Please refer to the manual of the WOL program you are using to find out how to configure the WOL function.

When using Linux you only need to switch to the console and type in the following command and your controller restarts:

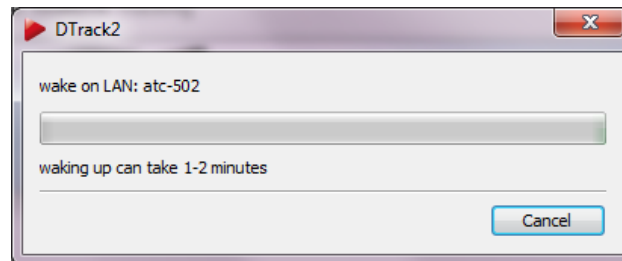
for Linux openSUSE:

```
$ wol <MAC address of your Controller>
e.g.: $ wol 00:1D:92:3A:58:5F
```

for Ubuntu:

```
$ wakeonlan <MAC address of your Controller>
e.g.: $ wakeonlan 00:1D:92:3A:58:5F
```

7.2.4 Configuring your controller without the *DTrack2* frontend

It is possible to retrieve ('information file') and to configure ('setup file') the current settings of the controller without the *DTrack2* frontend software. You only need a standard USB pen drive (FAT32 formatted).

 **Please note that these settings are not part of your personal configuration. Changes will affect all users of your controller! Your controller may become unreachable with wrong IP settings!**

- Plug the USB pen drive in any available USB port of the controller. Controller can be powered up or off
- If necessary start up the controller
- Wait some time for the controller to write two files onto the USB pen drive (approx. 20-30 seconds, signalled by two (2) consecutive beeps)
- Unplug the USB pen drive
- Now view the information file 7.2.4.1 on page 74 or edit the setup file 7.2.4.2 on page 74 with any editor
- When changing the setup file please plug the USB pen drive in the controller again afterwards
- Wait some time for the controller to read the setup file (approx. 20-30 seconds, signalled by three (3) consecutive beeps)
- Unplug the USB pen drive
- Reboot the controller for the changes to take effect

Now, your controller is configured according to your requirements.

7.2.4.1 The information file

This file contains the current settings of the controller. Following, a description of the file format (e.g. ART_Controller_0007_info.txt):

ART Controller Information:

```
Name           : smarttrack-0007
Serial Number   : 0007

Ethernet (LAN)  : dhcp
Ethernet IP (LAN) : 10.10.99.196 255.255.0.0
Ethernet MAC (LAN): 00:03:1d:0b:0f:36

Gateway (LAN)   : 10.10.0.3

Domain Name     : xyz.site
Domain Name Server: 10.10.0.1
```

7.2.4.2 The setup file

This file is used to:

- configure the controller to be a DHCP client,
- set a static IP address and
- to carry out a factory reset.



You can find your current license codes in the file 'ART_Controller_XXXX_licenses.txt' (will be written to USB pen drive during factory reset)



Carrying out a factory reset will result in the loss of all your settings including your license codes! Backup your configurations or export your systems configuration log file beforehand (please refer to 7.4.2.1 and 7.4.2.2 on page 88).

Following, a description of the file (e.g. ART_Controller_00117_setup.txt) format:

```
# ART Controller Setup:

# ethernet settings:
# - uncomment just one of the lines starting with 'SETNET'

# ethernet settings: DHCP
# - uncomment the following line to activate DHCP
#SETNET="dhcp"

# ethernet settings: fix IP address and subnet mask
# - uncomment the following line to set a fix IP address and subnet mask
#SETNET="ip 192.168.0.1 255.255.255.0"

# ethernet and routing settings: fix IP address, subnet mask and corresponding gateway
# - only use if destination for tracking data or DTrack2 frontend is in a different network than ATC
# - note: gateway must be an IP number in same network/netmask as ATC!
# - uncomment the following line to set a fix IP address, subnet mask and gateway IP address
#SETNET="ip 192.168.0.1 255.255.255.0 192.168.0.253"

# name settings: host name
# - uncomment the following line to set the host name
#SETHOSTNAME="atc"

# name settings: domain name
# - uncomment the following line to set the domain name
#SETDOMAINNAME="art.site"

# name settings: domain name server
# - uncomment one of the following lines to set (or clear) a domain name server
#SETNAMESERVER="192.168.0.254" # set DNS (IP or hostname)
#SETNAMESERVER="-" # clear DNS

# factory reset of all other settings:
# - CAUTION: use with care, all your settings will be lost!
# - uncomment the following line to reset all other Controller settings
```

7 DTrack2 frontend software

```
# - additionally your ethernet settings will be set to DHCP if no fix IP is set above
# - CAUTION: also all license settings will be reset!
#   - export 'system informations' (DTrack2->Configuration) to save your license codes;
#     or see 'ART_Controller_X_licenses.txt' (will be written to USB stick during factory reset)
#   - re-enter all license codes after factory reset under DTrack2->Licenses
#RESETSETTINGS="yes"
```

Example:

If you would like to set a static IP you have to remove the '#' sign and enter the desired IP address (here e.g.: 123.123.0.1)

before:

```
#SETNET="ip 192.168.0.1 255.255.255.0"
```

after:

```
SETNET="ip 123.123.0.1 255.255.255.0"
```

7.2.5 Remote command strings

The following commands may be used in combination with DTrackSDK to control the tracking system remotely (e.g. with your media control) and without the *DTrack2* frontend.

Command string	Description
dtrack2 tracking start	Start tracking
dtrack2 tracking stop	Stop tracking
dtrack2 system shutdown	Shut down <i>SMARTTRACK</i> (WOL active)
dtrack2 get config active_config	Get currently active config ID, e.g. 'config20160808102933552'
dtrack2 set config active_config <ID>	Select an existing configuration. Warning: Must use <ID>, not name of configuration, except for default configuration (see next entry). Find under <i>Edit</i> button, e.g. 'config20160808102933552'
dtrack2 set config active_config standard	Set back to default configuration
dtrack2 get status active	Check whether tracking is currently measuring: none (stopped), mea (measuring), cal (running a calibration), wait (waiting for external sync input) or err (error in starting measurement)
dtrack2 get system access <i>supported on 2nd connection</i>	Check whether control connection can be established: full if accessible, none if not. none usually means another front-end is connected
dtrack2 get system accessed_by <i>supported on 2nd connection</i>	Ask who is currently connected with full access, e.g. to find front-end blocking shutdown from Crestron/AMX

Table 7.2: Remote command strings

To send a command, a TCP connection to port 50105 of the server has to be opened and the commands (see table 7.2 on page 76) can be sent. The controller replies with either "dtrack2 ok" or with an error message for commands and set requests, or with result

strings in case of a get request.



Please ensure that the commands are sent exactly in the given way, with exactly one blank (0x20) between the elements and no trailing blanks, CR or LF characters, but including a trailing NUL (0x00) character.

Multiple remote connections *DTrack2* allows multiple clients to connect to the controller, but only the first connection is allowed to send commands except for those listed for secondary connections above. Therefore, scripts can test whether another client is connected to the controller. To do this, the command `dtrack2 get system access` checks the availability. It must return **full**; if it returns **none**, another process is already connected to the command port. In this case, the request `dtrack2 get system accessed_by` can be used to find the host of the connection.

It is recommended to use *DTrackSDK* (available under C++ and Java) to implement command support into own software and to use the *DTrack2* CLI software to send commands from scripts. Both *DTrackSDK* and *DTrack2* CLI are available for Windows and Linux, and can be downloaded after registering on the support part of the *ART* web page at <http://www.ar-tracking.com/support/>

When using the *DTrack2* CLI tool, please make sure to send commands and parameters as one argument by using quotes:

```
DTrack2CLI myATC -set "config active_config" "config20170724121806418"
```

```
DTrack2CLI myATC -get "config active_config"
config20170724121806418
```

```
DTrack2CLI atc-301604025 -cmd "dtrack2 set config active_config config20160808102933552"
```

```
DTrack2CLI atc-301604025 -get "config active_config"
config20160808102933552
```

To switch back to the default configuration use the following command:

```
DTrack2CLI atc-301604025 -set "config active_config standard"
```

```
DTrack2CLI atc-301604025 -get "config active_config"
standard
```

Linux For Linux shell scripts, additionally the 'nc' command can be used, e.g:

```
\$ echo -n "dtrack2 system shutdown" | nc 10.10.9.44 50105
dtrack2 ok
```

7.3 Main GUI

The graphical user interface of *DTrack2* can be divided into the following parts (see figure 7.5 on page 78):

- the menu bar with access to all settings (please refer to chapter 7.3.1 on page 78)
- the toolbar with graphical elements regarding the status of the tracking system (please refer to chapter 7.3.2 on page 80)
- the docking displays with graphical information (see chapter 7.3.3.1 on page 81) and measurement results (please refer to chapter 7.3.3 on page 81).

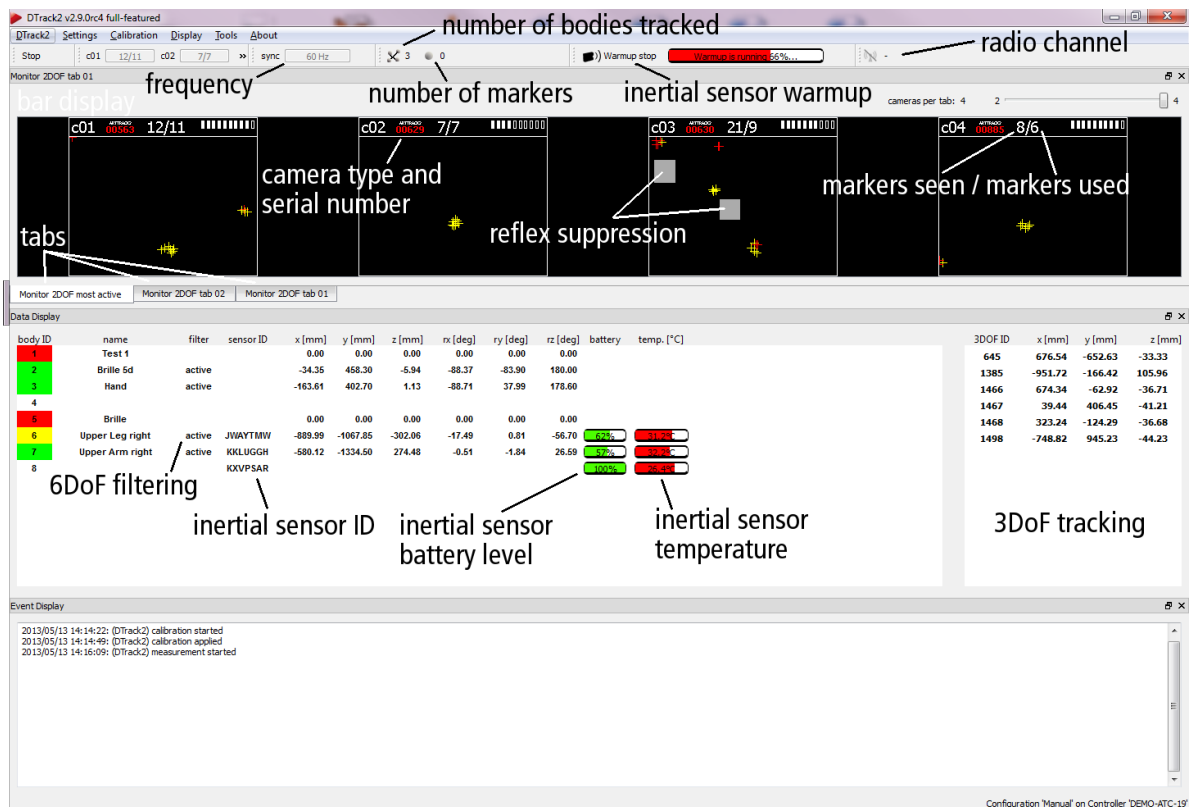

Figure 7.5: Graphical user interface of *DTrack2*

7.3.1 Menu bar overview

DTrack2	<i>Shortcut</i>	page 86
<i>Licenses</i>		License overview → Adding licenses (e.g. Measurement Tool)
<i>Configurations</i>		Select, create new and save different configurations, lock the current configuration, backup all settings or export system information
<i>Start/Stop</i>	M	Start/Stop measurement

<i>Controller standby</i>		Force the controller to go into standby mode
<i>Quit</i>	Q	Quit <i>DTrack2</i>

Settings	<i>Shortcut</i>	page 90
<i>Cameras</i>	F7	Camera settings (e.g. flash intensities, syncgroup assignment)
<i>Synccard</i>		Synccard settings (e.g. tracking frequency, external synchronisation)
<i>Inertial Sensor</i>		Settings for inertial sensors
<i>ART Radio Info</i>		Settings for ART radio transceivers and devices within your setup
<i>Tracking</i>		Activate 3DOF calculation, automatic start of measurement
<i>Body Administration</i>	F8	General settings for all targets and interaction devices
<i>Output</i>	F9	Set output channels and configure the data to be transmitted
<i>Flystick</i>		Configure your Flystick
<i>Measurement Tool</i>		Configure your Measurement Tool
<i>Controller</i>		Configure the IP and NTP settings of your controller

Calibration	<i>Shortcut</i>	page 104
<i>Start static reflex scan for all enabled cameras</i>		Starts the static reflex scan
<i>Inertial Sensor Calibration</i>		Re-calibrate the drift correction of the inertial sensor
<i>Room</i>	F5	Room calibration
<i>Room adjustment</i>	Shift + F5	Adjust / transform the room coordinate system
<i>Body</i>	F6	Body calibration
<i>Body adjustment</i>	Shift + F6	Adjust / transform the body coordinate system
<i>Hybrid Body</i>		Determine the relative rotation between optical and inertial sensor (i.e. run hand-eye calibration)
<i>Measurement Tool</i>		Start tip calibration process for the Measurement Tool

Display	<i>Shortcut</i>	page 125
<i>Monitor 2DOF</i>		Graphical display of markers recognized by the cameras
<i>Data</i>	F10	Display measurement results (6DOF and / or 3DOF)
<i>Flystick</i>		Display Flystick measurement data
<i>Measurement Tool</i>		Display Measurement Tool data
<i>Events</i>		Display event messages generated by <i>DTrack2</i>
<i>Set to default</i>		Reset the shown displays to default

Tools	<i>Shortcut</i>	page 126
<i>Controller Update</i>		Start the assistant for the controller update
<i>Measurement Tool demo</i>		Provides simple measurement acquisition for use with the Measurement Tool

About	Shortcut	page 128
<i>DTrack2</i>		Software version of frontend & backend
<i>About Qt</i>		Qt toolkit version
<i>What's new?</i>		Overview of the new features
<i>What's this?</i>	Shift + F1	Help

Table 7.3: *DTrack2* menu structure overview

7.3.2 Toolbar

By default, the toolbar (see figure 7.5 on page 78 consists of the following elements (from left to right):

Toolbar element	Description
<i>Start/Stop button</i>	Starts and stops the measurement
<i>Camera Status</i>	Shows the number of markers seen / tracked for each camera (2DOF)
<i>Sync Status</i>	Displays the current tracking frequency
<i>Tracking Status</i>	Shows the number of tracked targets (6DOF) / single markers (3DOF)
<i>ART Radio Status</i>	Displays the currently selected channel of the ART radio transceiver (greyed out, if not installed)
<i>ART InertialSensor Status</i>	Displays the currently selected channel of the inertial dongles (wireless only) and the status of the sensor's warm up process (greyed out, if not installed)

To change or activate elements right-click anywhere on the toolbar. Drag & drop the elements for re-arrangement by left-clicking.

The *Sync status* field is changing its colour from grey to yellow, then orange and finally red in case the effective frequency is decreasing due to processing overload (see figure 7.6 on page 80):

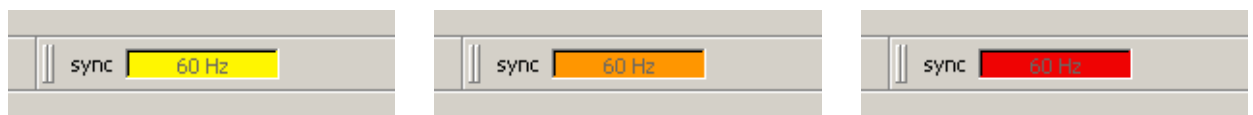

(a) yellow: 5 - 10 frames per minute lost

(b) orange: 10 - 15 frames per minute lost

(c) red: > 15 frames per minute lost

Figure 7.6: Visualization of the synchronization frequency decrease

- grey: max. 5 frames per minute lost (i.e. 3600 frames per minute are transmitted, not shown)

- yellow: 5 - 10 frames per minute lost
- orange: 10 - 15 frames per minute lost
- red: > 15 frames per minute lost

7.3.3 Docking Displays

By default the first three of the following docking displays are activated (see figure 7.5 on page 78).

Docking Display	Description
<i>Monitor 2DOF</i>	Graphical display of all markers seen / tracked by the cameras. Colour and shape represent the circularity and size of the markers, respectively.
<i>Data Display</i>	Displays measurement results (6DOF and / or 3DOF)
<i>Event Display</i>	Displays DTrack2 events (e.g. "no valid room calibration")
<i>Flystick</i>	Shows the measurement results (6DOF) of the Flystick and the operation of buttons and joystick
<i>Measurement Tool</i>	Shows the measurement results of the Measurement Tool and its reference body, if assigned

To change or activate the docking displays right-click anywhere on the toolbar or use the menu *Display* (refer to chapter 7.7 on page 125). Drag & drop the display windows for re-arrangement by left-clicking.

7.3.3.1 Monitor 2DOF display

The *Monitor 2DOF display* essentially is a 2-dimensional graphical display of all markers / flashes or other IR sources that can be seen inside the FoV of the cameras. It is particularly useful for the adjustment (especially orientation) of the **SMARTTRACK** (refer to chapter 4.1.4 on page 29).

The *Monitor 2DOF display* shows a black window for each camera (equivalent to the field of view) with a schematic display of positions, size and shape of all recognized markers.

Cameras per tab The special tab '*most active cameras*' contains only those cameras which see the markers / targets most of the time.

Marker display Each marker is either displayed as a circle or as a cross. This indicates the projected size of the marker on the camera sensor and depends strongly on the distance to the camera. A simple color code represents the quality (i.e. circularity) of the markers.

green markers	...	very good tracking quality
yellow markers	...	good tracking quality
red markers	...	bad circularity, unreasonable size of marker and / or low intensity; may result in poor tracking quality
circles	...	big marker (e.g. close to camera)
cross	...	small marker

Recommendation Increase the flash intensity until all markers are yellow or green. Additionally the intensity of the brightest pixel in the field of view is shown using a simulated LED bar display (refer to figure 7.5 on page 78).

As a rule of thumb: for measurement applications with high accuracy requirements the markers should be displayed in green with intensities of min. 4 bars; for VR applications yellow markers with intensities down to 2 bars are sufficient.

Additional *Monitor 2DOF display settings* In the *Monitor 2DOF display* additional functions are assigned to mouse interactions.

- left mouse button
Drag & drop to move the camera monitors' position within the *Monitor 2DOF view*.

- middle mouse button
Click to hide all camera monitors but the one you selected. Click again and all camera monitors will be displayed.

- right mouse button
Click on a camera monitor to open a menu for the respective camera settings; see table 7.4 on page 83 and figure 7.7 on page 82 for more details.

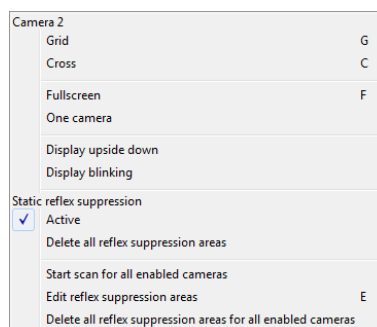

Figure 7.7: Monitor 2DOF view menu (e.g. camera 2)

Function	Shortcut	
<i>Grid</i>	G	Shows a grid in the camera display.
<i>Cross</i>	C	Shows a cross in the camera display.
<i>Fullscreen</i>	F	Resizes <i>Monitor 2DOF view</i> to full screen and back.
<i>One Camera</i>		Only show the view of the selected camera.
<i>Display upside down</i>		Switch display orientation by 180°. 'UD' is displayed in the camera display.
<i>Display blinking</i>		ARTTRACK5 only : Activates / deactivates blinking of 2-digit LED matrix and status LEDs on the camera for easy identification.
<i>Static Reflex Suppression Active</i>		Enable static reflex suppression functionality for this camera. 'SR' is displayed in the camera display.
<i>Delete all reflex suppression areas</i>		Deletes the defined reflection areas for the selected camera only.
<i>Start scan for all enabled cameras</i>		Initiates a scan for static reflections. Enabled only if <i>Active</i> is ticked.
<i>Edit reflex suppression areas</i>	E	Enter the reflex suppression area edit mode in order to manually suppress unwanted reflections.
<i>Delete all reflex suppression areas for all enabled cameras</i>		Deletes the defined reflection areas for all enabled cameras at once.

Table 7.4: Features of the *Monitor 2DOF view*

7.3.3.2 Data Display

On the left hand side, the *Data Display* shows the respective 6DOF measurement results (i.e. the position and orientation relative to the room coordinate system) of all calibrated bodies. The rotation angles are rotations around the X, Y and Z axis. The mathematical definition can be found in chapter B on page 155. The bodies are sorted by increasing *body ID*. A simple colour code indicates the tracking status of the body:

green	...	body is being tracked; tracking data is displayed
yellow	...	body is being tracked only by the means of the inertial sensors (rotational data only!)
red	...	body is not being tracked; instead of tracking data zeros are displayed
white	...	body is not calibrated; columns are left blank

Filtering of 6DOF measurement results Next to the *body ID* the filtering status (i.e. active or empty) is shown. The *Filter Settings* menu opens by right-clicking on the column *filter* for the corresponding target. For more information about filtering options please refer to chapter 7.5.6.1 on page 97.

Additional information for inertial sensors In the *Data display* additional information is provided for inertial sensors:

- sensor ID
- battery level
- temperature in °C



The temperature values between single inertial sensors may vary. The operating temperature is reached as soon as there are no more temperature changes inside the sensors indicated by a green status bar. It is not dependent on the absolute temperature value.

3DOF measurement results On the right hand side, the *Data display* shows the 3DOF measurement results. All recognized markers that have not been assigned to a calibrated 6DOF body (i.e. uncalibrated targets) and single markers are shown here.

Note: The *calculation of 3DOF markers* has to be activated in *Settings* → *Tracking* by ticking the checkbox. By default, the calculation is deactivated.

7.3.3.3 Flystick

The *Flystick* display shows the measurement results of the position and orientation of the *Flystick*. Additionally, the operation of the *Flystick* buttons and of the joystick are shown. A simple colour code indicates the status of the *Flystick*:

green	...	Flystick is being tracked; tracking data is displayed
red	...	Flystick is not being tracked (e.g. Flystick has not been assigned to ART radio transceiver); instead of tracking data dashes are displayed
blue	...	button is being pressed
white	...	Flystick is not calibrated; columns are left blank

7.3.3.4 Measurement Tool

The *Measurement Tool* display is split into two parts:

1. position and orientation of the Measurement Tool 's tip and the respective reference body
2. position and orientation of the reference body

A simple colour code indicates the status of the Measurement Tool and the reference body, respectively:

green	...	tool is being tracked; tracking data is displayed
red	...	tool is not being tracked (e.g. tip calibration is missing); instead of tracking data dashes are displayed
blue	...	measurement is being performed
white	...	tool is not calibrated; columns are left blank



A Measurement Tool with an assigned reference body can only be tracked when the reference body is tracked as well.

7.3.3.5 Event display

The *Event display* presents the status of the tracking system. It offers feedback of the operational state concerning errors or warnings. Furthermore, it informs the user about successful room or body calibrations. Each entry is associated with a timestamp and date.

7.4 Menu *DTrack2*

<i>DTrack2</i>	<i>Shortcut</i>
<i>Licenses</i>	
<i>Configurations</i>	
<i>Start/Stop</i>	M
<i>Controller standby</i>	
<i>Quit</i>	Q

Table 7.5: Menu *DTrack2*

7.4.1 License management

The capability of the tracking system is defined by licenses which can be managed here. Up to *DTrack2* v2.10 only one specific type of license was available for the SMART-TRACK. Starting with *DTrack2* version v2.10 a new license model has been established:

Feature	Values	Possible license status
<i>Inertial Sensors</i>		supported / not supported
<i>Measurement Tool</i>		supported / not supported
<i>DTrack2 max. B bodies</i>	B = 4, 10, 30	supported
<i>DTrack2 all bodies</i>		supported

Table 7.6: Licenses overview



The maximum number of bodies that may be used with a SMART-TRACK includes all calibrated interaction devices (Flystick and Measurement Tool)!

You can upgrade to any functionality by simply entering a license code. Ask your **ART** representative for pricing (see figure 7.8 on page 87).

Example If you want to add the Measurement Tool , go ahead as follows:

- Select the feature *Measurement Tool* .
- Click on *Hardware Info*.
- Contact **ART** and communicate your version of *DTrack2* together with the serial number of the synccard or the MAC address of the Ethernet port (= *Identification*) in order to receive a valid license code.
- Exit the window *Hardware Info* and enter a valid license code in the field *new license code*.

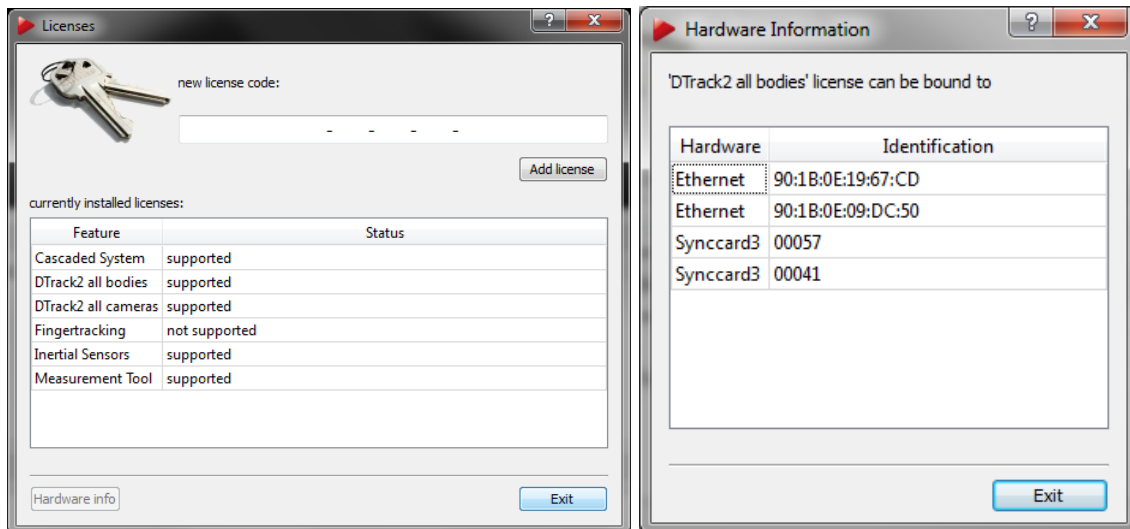

(a) Licenses overview

(b) Hardware information

Figure 7.8: Managing the licenses

- Click on *Add license*.

The process is the same for other modules.

7.4.2 Configuration management

It is possible to create personalised configurations, e.g. with different targets or flash settings. You can assign a user name and, if necessary, lock the settings by password-protection. Press *New* to create a new personal configuration (see also figure 7.9 a on page 88).

Assign a meaningful description (→ '*description*') and enter your user name (→ '*owner*') (see figure 7.9 b on page 88). Unless the configuration is password protected, it may be changed later on with *Edit*.

Your personal configuration is created using the settings / values of the currently active configuration (→ '*clone current configuration*') or by applying default values (→ '*create with default values*'), respectively:

- '*clone current configuration*'
all existing calibrations (room and body calibration) and flash settings are inherited from the currently active configuration.
- '*create with default values*'
the system will start from scratch - i.e. as manufactured. The system will not have a valid room calibration or any body calibrations.

Just press *Create* and the configuration is saved on the controller.

It is possible to protect the settings of any configuration with a password by pressing the button *Lock*. You will be asked to enter a new password to lock your configuration.

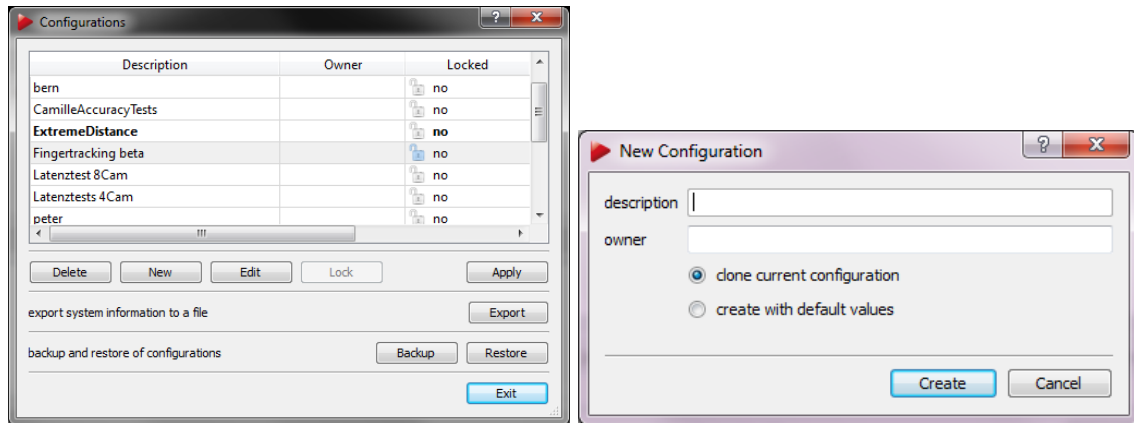

(a) Select a configuration

(b) Create a new configuration

Figure 7.9: Managing the configurations



Locking the configuration does not provide access-control! Only changes in settings / calibrations are disabled.



In case you forget the password please call *ART* for assistance

Any existing configuration may be activated by selecting the corresponding entry and clicking *Apply*. Quit this dialogue by pressing *Exit* - the configuration is loaded. Only existing configurations without password-protection can be deleted. Select the entry to be deleted and click *Delete*.

7.4.2.1 Backup of Configurations

It is possible to export and re-import single configurations or to backup all settings at once. 'Load' imports previously saved configurations. The imported configuration will be activated automatically. It is possible to import multiple configurations at the same time. 'Save' will open a window for selecting the configuration(s) to export. Either (de-)select individual configurations by left-clicking or *select all*. Tick the checkbox *all settings and configurations (backup)* to save a complete backup of your system's settings. Press 'Save' to select a destination directory on a remote PC. Please also refer to chapter 8.1 on page 130 for further information.



When exporting single or multiple configurations please assign meaningful filenames (e.g. exporting date 'Standard 07122012'). Configurations using the standard filename (e.g. "Standard") will be overwritten !

7.4.2.2 Export System Information

The export function is intended for saving an information file (i.e. number and types of camera, validity of room calibration, number and types of targets, current settings, event display logs, etc.) in case you need to contact tech support at *ART*. *Export* opens a new

window (see figure 7.10 on page 89 where a list of all event logs from the past 30 days is shown. Select the appropriate *File* by left-clicking or by moving the slider below the table to the left or right respectively. You can also enter the number of *last days* manually. Pressing *Export* saves the selected event logs together with a system information file in (ASCII-)TXT format on any remote PC in your local network.

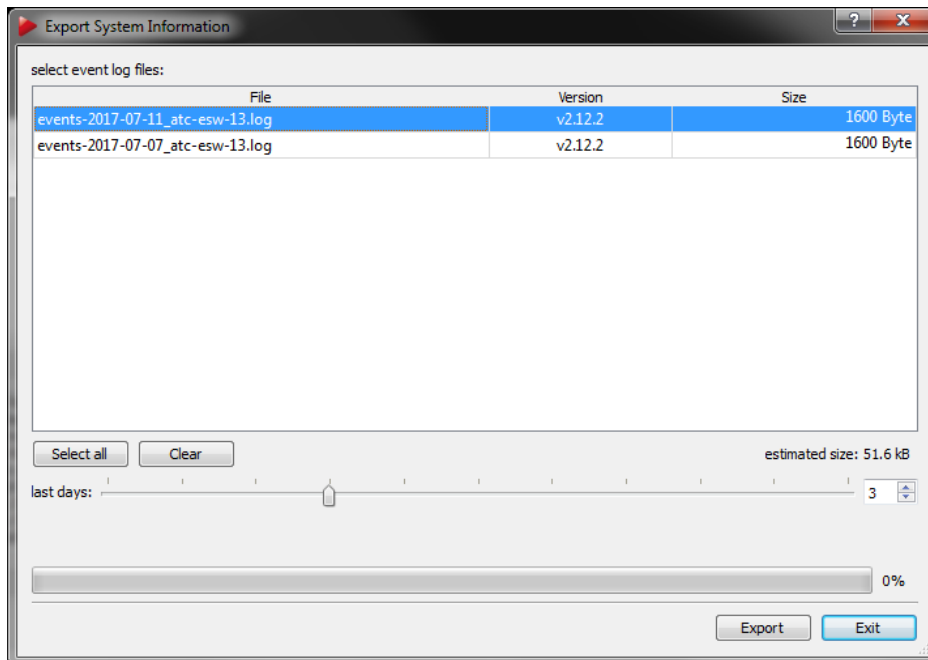

Figure 7.10: Export System Information

7.4.3 Start/Stop

Start/Stop measurement by pressing the button *Start / Stop* or by using the keyboard shortcut 'M'.

7.4.4 Controller standby

Force the controller to go into standby mode with this command. You can restart the controller manually or by using Wake On LAN. Please refer to chapter 7.2.3 on page 72 for more details.

7.4.5 Quit

Quit *DTrack2* frontend software. In case the system is still in measurement mode, a confirmation window will show up. You may leave the active measurement running, the frontend software will quit anyway.

7.5 Menu Settings

Settings	Shortcut
Cameras	F7
Synccard	
Inertial Sensor	
ART Radio Info	
Tracking	
Body Administration	F8
Output	F9
Flystick	
Measurement Tool	
Controller	

Table 7.7: Menu *Settings*

7.5.1 Cameras Settings

This dialogue (see figure 7.11 on page 90) offers the possibility to adjust the 'flash intensity', to activate the 'Static reflex suppression' and the 'modulated flash'.

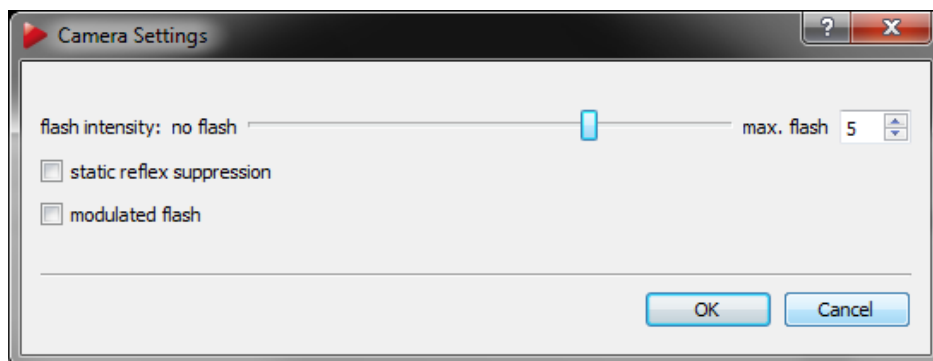

Figure 7.11: Camera Settings

Flash settings The flash intensity may be changed within an interval from 0 .. 7. This setting strongly depends on the working area and range. If you are working in a small area, where you are close to the **SMARTTRACK**, lower flash intensities may be sufficient. Otherwise, if your typical working distance is further away from the **SMARTTRACK** (but still within its tracking range), higher flash intensities may be necessary. Adjust the flash intensity that tracking quality is suitable using the *Monitor 2DOF display*. Please refer to chapter 7.3.3.1 on page 81 for instructions.



Keep a distance of min. 20 cm when operating the SMARTTRACK ! It is assigned to the Exempt Group according to IEC62471-1 and therefore poses no risk or hazard to the human eye or skin at this distance.

Static reflex suppr. Tick the corresponding checkbox to activate the support of static reflex suppression. Please refer to chapter 7.6.1 on page 104 for further information.

Modulated flash The *SMARTTRACK* can be used with active markers, i.e. markers consisting of infrared LEDs instead of retro reflective material (see chapter 3.2 on page 19). Tick the checkbox *modulated flash* to activate the synchronization signal (i.e. coded IR flash) that triggers active targets.



Due to the modulation the effective flash intensity is reduced when it is used in combination with low flash intensities. The influence is neglectible at higher flash intensity settings. Simply increase the flash intensity, if necessary.



The range of the modulated flash is significantly higher than the tracking distance of the *SMARTTRACK*

7.5.2 Synccard Settings

This dialogue shows the model and the serial number of the synccard. Furthermore, it offers a dropdown list to select the mode of synchronization.

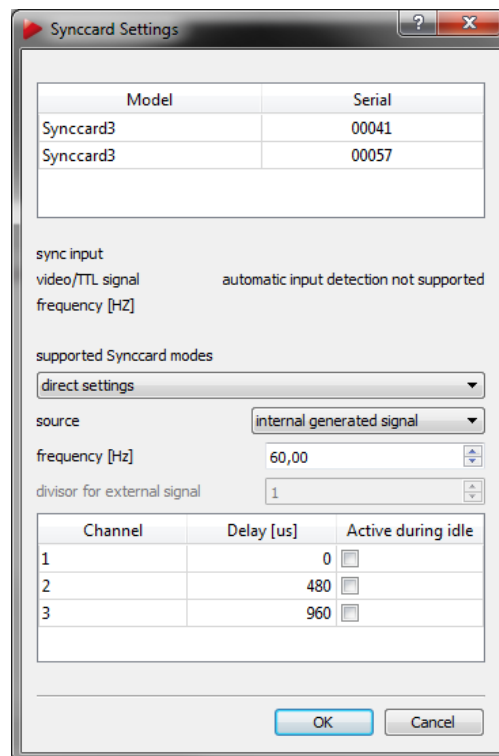

Figure 7.12: Synccard Settings

7.5.2.1 Synccard Modes

The available modes for synchronization are shown in table 7.8 on page 92.

Supported synccard mode	field of application
<i>internal generated signal (values dependent on camera model)</i>	run the controller without external synchronization
<i>external video signal</i> <i>external video signal, for validated shutter glasses ¹</i> <i>external video signal, for validated shutter glasses, divisor 2 ²</i>	active-stereo projection with an analogue video sync signal (=VGA)
<i>external TTL signal</i> <i>external TTL signal, for validated shutter glasses ¹</i>	active-stereo projection with a TTL sync signal, triggers on rising edge
<i>direct settings</i>	advanced custom settings

¹ predefined settings that should be used with the shutter glasses described in table 7.9 on page 92

² use this mode if the frequency of the external synchronization signal is 2x higher than the max. framerate of the **SMARTTRACK**

Table 7.8: Overview of the supported synccard modes

Brand	Type
RealD	CrystalEyes 1, 2, 3, 5
NuVision	APG6000, APG6100
XPand	X101, X103 (with NuVision Long-Range Emitter), X104LX
NVidia	3D Vision Pro (RF sync'ed)
Volfoni	EDGE (with Volfoni or NuVision LR Emitter)
Virtalis	ActiveWorks 500

Table 7.9: Overview of validated shutter glasses

7.5.2.2 Direct Settings

If you select '*direct settings*' you may use advanced options for configuring the synccard:

Option	Description
<i>source</i> <i>frequency [Hz]</i>	configure the type of synchronization to be used enter the tracking frequency manually (10 - max. framerate of SMARTTRACK)
<i>divisor for external signal</i>	reduce the tracking frequency by a factor 1 - 10 (only for external synchronization)
<i>Delay [us]</i>	configure the delay between the external synchronisation signal and SMARTTRACK exposure (only <i>Channel 1</i>)

Source The available options '*internal*', '*video*' and '*ttl*' are equivalent to the aforementioned supported synccard modes (see table 7.8 on page 92). Additionally the option '*ttlinv*' is available, which inverts the external synchronization signal (i.e. switches TTL high / low states to trigger on falling edge instead of rising).

Frequency [Hz] The tracking frequency can be set between 10 Hz and the max. frame-rate of the **SMARTTRACK** in steps of 1 Hz.

Divisor for external signal If the frequency of the external synchronisation source is higher than the max. frame rate of the **SMARTTRACK**, a divisor can be set to reduce the frequency accordingly.

Delay [us] When working with external synchronisation a time delay can be set between the trigger signal and the actual exposure time of the **SMARTTRACK** (only *Channel 1*). If necessary, the default value ($0\mu\text{s}$) can be increased individually. Note: The max. delay is $4000\mu\text{s}$.

7.5.3 Inertial Sensor Settings

This dialogue is the center for configuration and calibration of inertial sensors (license for **DTrack2** necessary !). Please refer to chapter 6 on page 52 for more information how to install inertial sensors. When using inertial sensors you can additionally select the pulse generating source for the tracking frequency here. Please refer to chapter 6.2.5 on page 65 for more information.

7.5.4 ART Radio Info

Here you can configure the settings of the **ART** radio transceiver. Additionally you will get information about all attached interaction devices (e.g. Flystick).

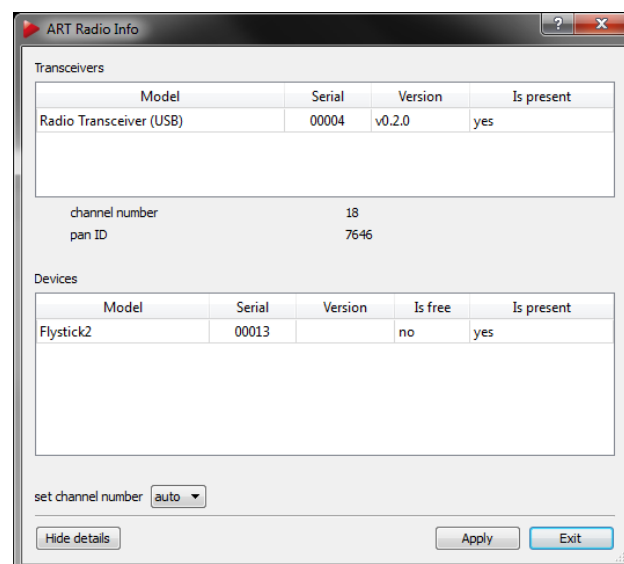

Figure 7.13: ART Radio Info Settings



The SMARTTRACK comes with an integrated radio transceiver. There is no need to plug in an additional USB Radio Transceiver (RT3)

The following information is offered:

Info	Description
<i>Model</i>	Shows the model of the transceiver or the device respectively
<i>Serial</i>	Shows the serial number of the transceiver or device respectively
<i>Version</i>	Shows the firmware version of the transceiver
<i>Is present</i>	('yes'): The transceiver is connected, the device is in range
<i>Is free (only for Devices)</i>	('yes'): The device is available for communication and has not been assigned yet, 'no'): The device is already assigned to a transceiver

Show details By clicking the button *Show details* the drop-down menu for selecting the radio channel of the radio transceiver is shown.

Set channel number By default the radio transceiver is automatically selecting a radio channel during booting, the drop-down menu is set to ('*auto*'). You may also select a specific channel manually. The selected setting is saved persistently.

7.5.5 Tracking Settings

In this dialogue you can enable / disable the calculation of 3DOF markers as well as the automatic start of measurement after booting. Here you can also define the central axis for all 5DOF targets globally.

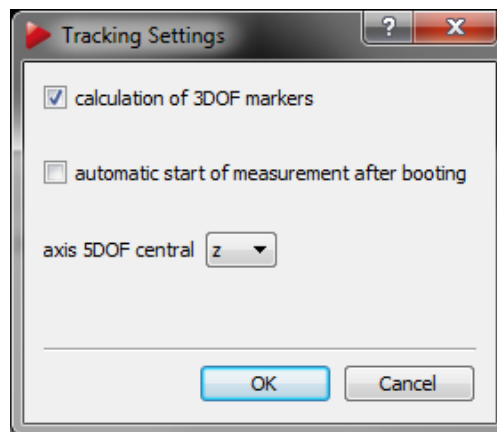

Figure 7.14: Tracking Settings

3DOF single markers The calculation of single markers is disabled by default. By enabling '*calculation of 3DOF markers*' the tracking data appears on the right hand side of the data display (refer to chapter 7.3.3 on page 81).

Automatic start of measurement By activating the feature '*automatic start of measurement after booting*' the tracking system starts measuring as soon as the controller has booted up. This is useful to run systems without the *DTrack2* frontend.

Axis 5DOF central Select the axis using the drop-down menu '*axis 5DOF central*'. Please refer to chapter 7.6.5.5 on page 118 for details.

7.5.6 Body administration

This dialogue (see figure 7.15 on page 95) allows for managing all targets (e.g. Standard, Flystick, Measurement Tool, etc.) in the system. The number and types of bodies to be tracked may be configured in here. You can also assign names, delete or reset target calibrations, activate filtering of 6DOF tracking data or change the order in which the targets appear in the data display (refer to chapter 7.3.3 on page 81).

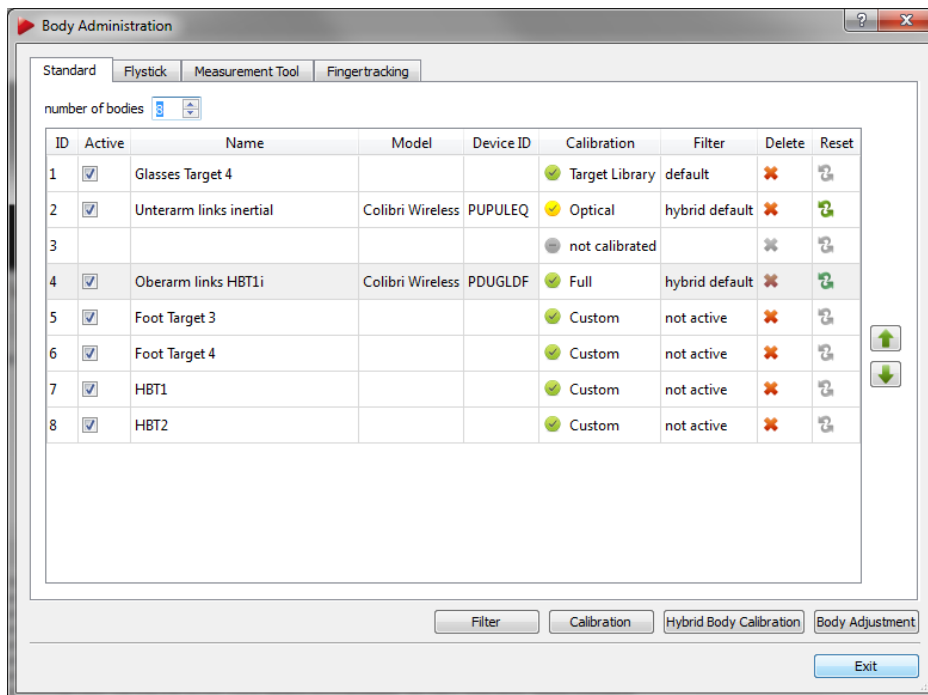

Figure 7.15: Body Administration (from *DTrack2* v2.9.0)

Using the different tabs on the top you can configure standard bodies or interaction devices. Please use the tabs *Flystick* or *Measurement Tool* accordingly.

In the bottom right of the dialogue (see figure 7.15 on page 95) you will find four buttons for direct access to other functionalities:

The following table (7.11 on page 96) shows a detailed description of the functions in the dialogue:

Button	Description
<i>Filter</i>	Deactivate the filtering of tracking data for each target, filtering is activated by default. A detailed description of the filtering options can be found in chapter 7.5.6.1 on page 97.
<i>Calibration</i>	Switch to the Body Calibration dialogue and perform the optical calibration for the selected target. A detailed description for body calibration can be found in chapter 7.6.5.2 on page 116.
<i>Hybrid Body Calibration</i>	Access the Hybrid Body Calibration dialogue and perform the calibration for the selected hybrid target. A detailed description for hybrid body calibration can be found in chapter 6.2.3 on page 61.
<i>Body Adjustment</i>	Go to the Body Adjustment dialogue and perform the necessary adjustment for the selected target. A detailed description for body adjustment can be found in chapter 7.6.6 on page 122.

Table 7.10: Body Administration - Detailed description of the Controls

Info / Action	Description
<i>number of bodies</i>	Increase / Decrease the number of accessible slots (i.e. body IDs) for calibration of targets.
<i>ID</i>	The targets are sorted in ascending order (i.e. increasing body ID).
<i>Active</i>	Activate or deactivate a target by ticking. Data of deactivated targets will not be transmitted in the data stream. The target sequence will not be affected.
<i>Name</i>	Change the name of a target by clicking. The target sequence will not be affected.
<i>Model</i>	Additional info about the model of an optionally assigned inertial sensor.
<i>Device ID</i>	The device ID of an optionally assigned inertial sensor.
<i>Calibration</i>	Provides information about the target calibration status.
<i>Filter</i>	Deactivate the filtering of tracking data for each target, filtering is activated by default. A detailed description of the filtering options can be found in chapter 7.5.6.1 on page 97.
<i>Delete</i>	Delete the calibration data of a target - effective immediately after confirming the query. The target sequence will not be affected.
<i>Reset</i>	Reset the calibration to predefined ' <i>Target Library</i> ' values, in case the geometry has been re-calibrated by the user manually after initial calibration via the ' <i>Target Library</i> ' function.
<i>Change order</i>	With the arrows on the right-hand side of the window you may rearrange the order of the targets. The data output will change accordingly.

Table 7.11: Body Administration - Detailed description



The maximum number of bodies depends on your license and includes ALL calibrated interaction devices (e.g. 4 body license: 2 standard bodies + 1 Flystick + 1 Measurement Tool). Hybrid targets are listed as standard bodies, with additional info about the model of the inertial sensor and its device ID.

The column *Calibration* (see figure 7.15 on page 95) provides information about the target calibration status:

- '*not calibrated*' means that a customized target has not been calibrated yet.
- '*Target Library*' means that the predefined calibration file from the system is being used.
- '*Target Library, re-calibrated*' means that the predefined calibration file has been used, but the geometry has been re-calibrated manually.
- '*Custom*' means that a manual body calibration has been performed.
- '*Optical*' means that an inertial sensor has been disassociated from a fully calibrated hybrid body .
- '*Full*' means that a hybrid body calibration has been performed or that predefined calibration data stored inside the hybrid inertial sensors is being used.

7.5.6.1 Filtering options for 6DOF tracking data

DTrack2 incorporates advanced filtering options for enhanced 6DOF tracking performance. One can choose between recommended presets or customize filtering options in order to optimize tracking behaviour individually for each target. For example in applications where reference targets are used to calculate the position of a seating buck it is possible to apply a strong filter for these targets which results in practically noise-free tracking data. On the contrary tracking (e.g. of HMD units) oftentimes calls for a compensation of system intrinsic latencies. Here **DTrack2** is able to deliver tracking data that incorporates probabilistic prediction up to tens of milliseconds ahead in time.

Either by using the menu *Body Administration* or directly through the main GUI docking window *Data Display* one can set the filtering options for each target. Please refer to table 7.10 on page 96 and 7.3.3.2 on page 83 to open the menu *Filter Settings*.

Filter Settings Filtering of 6DOF tracking data is activated by default. Untick the checkbox '*active*' to deactivate filtering for the respective target or choose from several recommended presets shown in the following table:

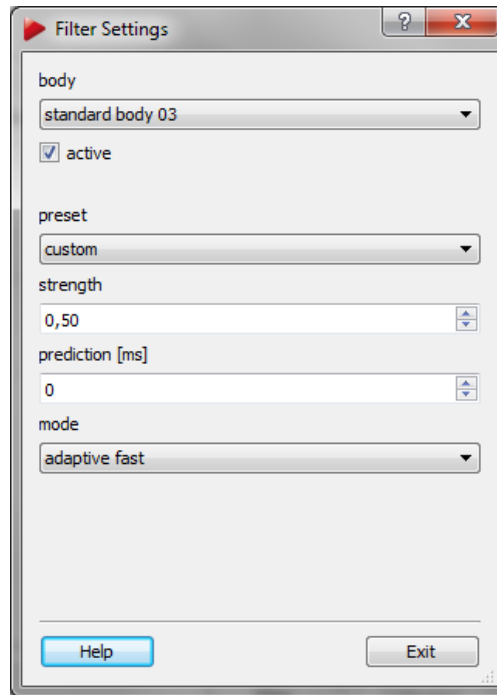

Figure 7.16: Filter Settings

Presets optical tracking	Description
<i>custom</i>	Customizable preset. A detailed description of the parameters can be found in table 7.13 on page 99.
<i>default</i>	Standard filtering without prediction or smoothing.
<i>Flystick</i>	Recommended setting for use with a Flystick (responsive filtering, designed for fast to slow motions).
<i>HMD-1</i>	Recommended setting for tracking of a HMD without hybrid tracking (down-tuned filtering with prediction, designed for fast motions).
<i>medium prediction</i>	Filter with prediction of tracking data (less responsive filtering, designed for slow to medium motion).
<i>reference target</i>	Filter with smoothing for tracking of stable reference positions (strong non-responsive filter, designed for occasionally moving objects).
<i>smoothing (delayed)</i>	Filter with strong smoothing and high averaging (responsive filtering with high latencies, designed for recording of tracking data).
Presets hybrid tracking	Description
<i>hybrid custom</i>	Customizable preset. A detailed description can be found in table 7.13 on page 99.
<i>hybrid default</i>	Standard filtering for hybrid targets without prediction or smoothing (designed for e.g. Hybrid Motion Capture).
<i>hybrid HMD medium prediction</i>	Filter for hybrid targets with prediction of tracking data. (designed for e.g. HMDs)

Table 7.12: Filtering of 6DOF tracking data - Detailed description of the presets

It is also possible to customize the tracking behaviour to the requirements of the applica-

tion using the following tunable settings:

Settings	Description	Usage
<i>Strength</i>	Sets the strength of the filter. Low values lead to faster reaction but higher jitter. High values result in smoother output but slower reaction. Note: Not available for hybrid tracking.	A higher strength may be ideal for tracking seating bucks
<i>Prediction</i>	Predicts output for the specified time into the future (ms) in order to compensate tracking and rendering latency. Note: Too high positive values can increase jitter and reduce precision. Negative values can be used for smoothing the output at the cost of higher latency.	A negative prediction may be ideal for recording data and offline analysis.
<i>Mode optical tracking</i>	Specifies the elementary behavior of the filter. Several options are available:	for optical tracking only
'Adaptive fast'	Automatically adapts to the observed motion.	Moving targets that change between fast and slow motions, such as Flysticks.
'Adaptive slow'	Automatically adapts to the observed motion, with stronger filtering of fast motions.	Moving targets with slow and medium motions
'Fast'	Optimized for fast motions without special filtering of slower motions.	Targets where quick reaction is important, such as HMDs.
'Slow'	Optimized for medium motions without special filtering of slow motions.	Targets where quick reaction is important, but motions are slow.
'Static'	Optimized for targets that are known not to move at all.	Reference targets attached to non-moving objects
'Reference target'	Optimized for generally static objects, with automatic detection of occasional motions.	Reference targets attached to occasionally moving objects.
<i>Mode hybrid tracking</i>	—	for hybrid tracking only
'Hybrid target'	Optimized for non-HMD hybrid targets incorporating an inertial sensor unit.	Hybrid Motion Capture
'Hybrid HMD'	Optimized for HMD hybrid targets incorporating an inertial sensor unit	HMDs and similar projective units (e.g. AR glasses).

Table 7.13: Customizable preset 6DOF filtering - Detailed description of the parameters

7.5.7 Output Settings

In this dialogue one can determine the settings for data output via ethernet (see figure 7.17 on page 100). Tick the checkbox *active* on the corresponding tab to enable data output for each channel.

Please refer to chapter B on page 155 for the format of the data output.

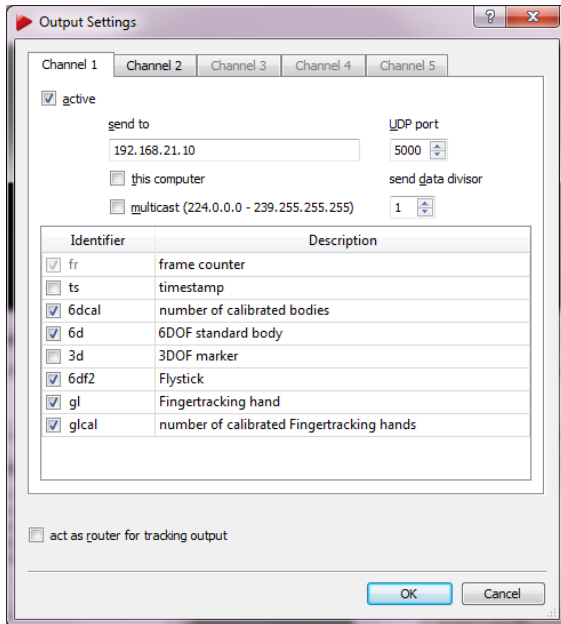

Figure 7.17: Output settings

Identifier	Description
fr	frame counter
ts	timestamp
6dcal	number of adjusted bodies
6d	6DOF standard body
3d	3DOF marker
6df2	Flystick
6dmt	Measurement Tool
6dmtr	Measurement Tool reference
6dmt2	Measurement Tool (also for ball probes)
6di	6D inertial body
6df	Flystick (old)
	only available if activated in Flystick settings (→ checkbox 'use old output format')

Table 7.14: Output identifiers

In total up to 5 UDP data output channels can be configured. You can send data to any computer within your local network. Just enter the IP address of the receiving client in the box *send to* and choose a UDP port number in *UDP Port*.

Tick the checkbox *this computer* instead to send the data to the remote PC from where you started the *DTrack2* frontend. You can also send the data to a group of addresses in the range of 224.0.1.0 to 239.255.255.255 by ticking the checkbox *multicast*.

In order to reduce the amount of data from the data stream you can define a '*send data divisor*' from 1 to 10. The divisor works the following way:

- 1 .. every frame is transmitted,
- 2 .. every second frame is transmitted,
- ...
- 10 .. every tenth frame is transmitted.



Double-check the currently used pulse generating source in the *Tracking* menu. Please refer to chapter 7.5.5 on page 94 for further information.



When using the '*timestamp*' please note the remarks on accuracy in chapter B.2.2 on page 162.

Act as router for tracking output The UDP output data may also be routed by *DTrack2* by ticking the checkbox *act as router for tracking output*. This functionality is especially important when it is not allowed to connect the controller to your local network due to IP security reasons.

The mandatory requirement for this function is that the PC running the *DTrack2* frontend is equipped with two ethernet LAN ports. One is needed for connecting the controller and one to your local network (see figure 7.18 on page 101). The data from the controller is then routed to the local network through the *DTrack2* frontend.

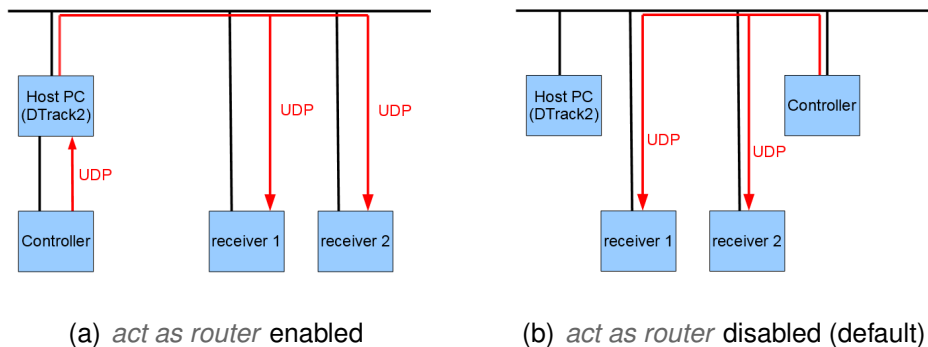

Figure 7.18: Depiction 'act as router' functionality



Using this function will cause a short delay due to forwarding of the data.



Do not use this function if the application PC and the controller are in the same network!

7.5.8 Flystick Settings

Inside this dialogue you can manage the *number of Flysticks* (max. 20) as well as the corresponding settings to be used.

For installation of Flystick2 please refer to chapter 5.1 on page 36. For Flystick3 see chapter 5.2 on page 40.

7.5.9 Measurement Tool Settings

Within this dialogue you can define the *number of Measurement Tools* and the *number of references* (max. 4 each).

Please refer to chapter 5.4 on page 47 to learn how to install the Measurement Tool .

7.5.10 Advanced Controller Settings

The menu *Advanced Controller Settings* is divided into two tabs - *Network* and *Time*.

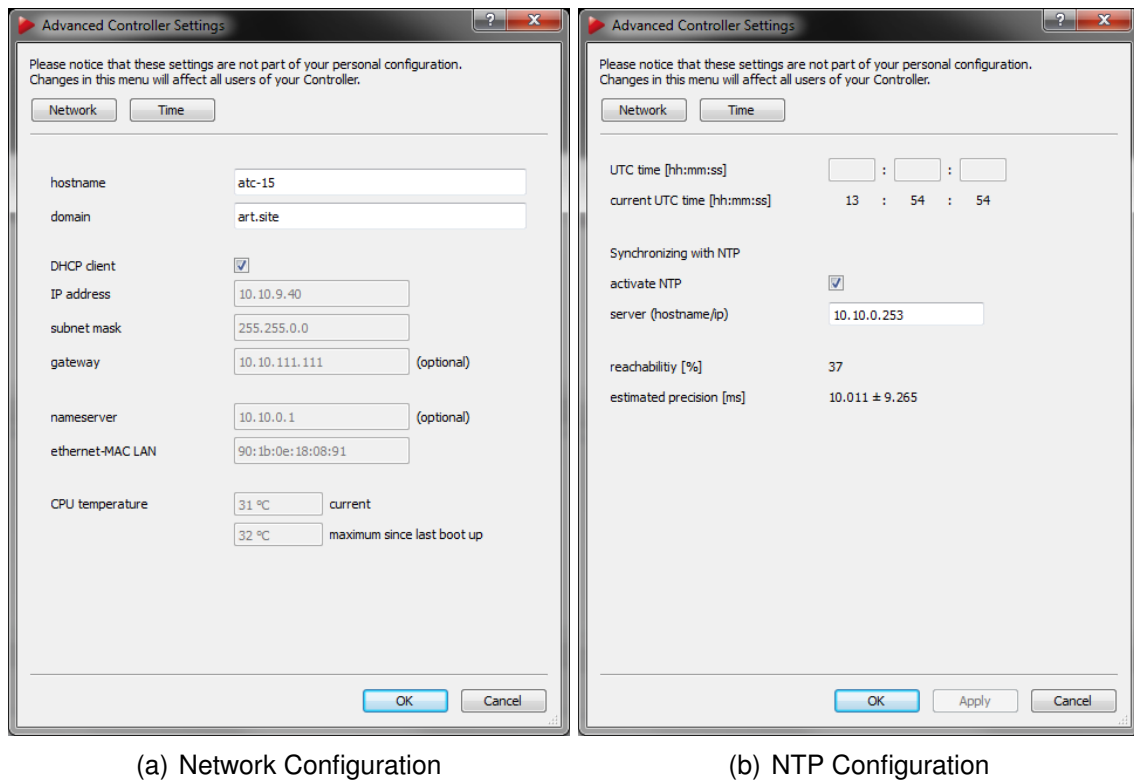

(a) Network Configuration

(b) NTP Configuration

Figure 7.19: Advanced Controller Settings

7.5.10.1 Network Configuration

On the *Network* tab you may change the network specific settings and watch the CPU temperatures inside the controller.

Network According to your network guidelines it may be necessary to specify e.g. *hostname* (not recommended!) and the *domain*.

When the checkbox *DHCP* client is ticked the controller may be connected to a LAN with DHCP support. The controller then works as a DHCP client. The *IP address*, *subnet mask*, *gateway* and *nameserver* assigned to the controller by the DHCP server is shown for your information.



If the network cable is unplugged or the DHCP support is unavailable while booting the controller uses its default IP address (i.e. 192.168.0.1).

By unticking the checkbox *DHCP* you may also specify a static *IP address*, *subnet mask*, *gateway* and *nameserver*. The MAC address of the controller is printed in the line *ethernet-MAC LAN* for your information. Please refer to chapter 7.2.2 on page 71 for details how to set a static IP address.

CPU temperature On the bottom of this dialogue you can read the CPU temperature inside the controller. The upper value shows the *current* temperature in °C, while the lower

value indicates the temperature *maximum since last boot up*, i.e. the highest temperature reached since the controller was started. When reaching elevated or critical levels, the values are highlighted in orange or red color.

7.5.10.2 NTP Configuration

On the *Time* tab you can set the **ART** controller's internal clock as well as synchronize it with a master clock (i.e. a reference time source) using NTP (=Network Time Protocol). NTP is a protocol designed to synchronize the clocks of computers over a network or even the internet (not recommended).

The *UTC time* (UTC = Coordinated Universal Time) can be set either manually using the entry fields [hh:mm:ss] or automatically by the master clock which itself has to be synchronized to UTC time beforehand. To activate the synchronization, tick the checkbox *activate NTP* and enter hostname or IP address of your server. When NTP is activated the **ART** controller is trying to connect to the NTP server repeatedly in order to update its clock. As a measure of quality for the connection to the NTP server check its '*reachability*'. The values can range from 0% to 100 %, with higher values showing good connection. Furthermore the quality of the synchronization of the master clock and the **ART** controller's internal clock is indicated by the '*estimated precision*' in the unit milliseconds (=ms).



Complete synchronization with NTP servers usually takes some time. In case of large differences between master clock and local time client the clock may be updated immediately but complete synchronization will still take some additional time.



Synchronization with NTP servers does not affect active measurements.



In general it is recommended to synchronize with a local master clock rather than directly to a remote time server on the internet. This reduces network latency and jitter, conserves bandwidth and limits the load on public time servers.

7.6 Menu Calibration

Calibration	Shortcut
<i>Start static reflex scan for all enabled cameras</i>	
<i>Inertial Sensor Calibration</i>	
<i>Room</i>	F5
<i>Room adjustment</i>	Shift + F5
<i>Body</i>	F6
<i>Body adjustment</i>	Shift + F6
<i>Fingertracking</i>	
<i>Measurement Tool</i>	

Table 7.15: Menu *Calibration*

7.6.1 Static reflex suppression

This starts the function of automatic reflex suppression. The feature can be enabled or disabled either globally for all cameras or individually for each camera in the camera settings (please refer to chapter 7.5.1 on page 90).

 **Be aware that reflex suppression leads to decreased FoV / effective measurement volume by blocking the area in which the reflection originated.**

There are two possibilities to carry out a reflex suppression:

1. automatic static reflex scan
A scan function will detect and suppress reflections automatically. Open *Settings* → *Camera Settings* and mark the checkboxes for each camera you would like to activate the reflex suppression feature. Please refer to chapter 7.5.1 on page 90 for details. Afterwards, select *Calibration* → *Start Static Reflex Scan for all enabled cameras* to start the scan.
2. manual static reflex suppression
Define areas to be suppressed manually (may be combined on top of an automatic scan). In the *Monitor 2DOF display*, right-click on the respective camera window and enable the Static reflex suppression by selecting the option 'Active'. Next start the edit mode by selecting 'Edit reflex suppression areas'. Alternatively you may use the shortcut ('E') shown in figure 7.20 on page 105).

 **Be sure to remove all targets from the measurement volume before starting the scan.**

Within the edit mode (see figure 7.20(b) on page 105) you may:

- create new areas,
- delete areas,

- clear regions,
- resize areas and
- move areas.

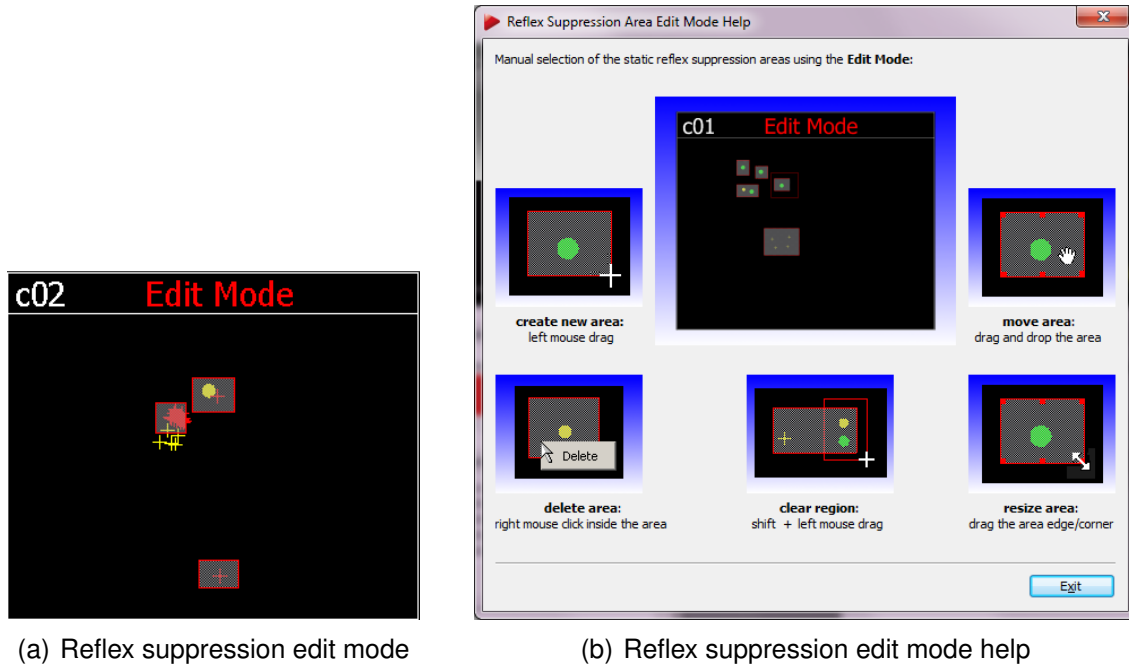

Figure 7.20: Reflex suppression

Reflex suppression areas are enabled as soon as you leave the edit mode (right click on the respective camera window, then de-select '*Edit reflex suppression areas*') and accept the changes. The single areas defined are stored in the controller and can be edited each time you enter this mode.

If you want to disable all reflex suppression areas for a camera at the same time, just right-click on the respective camera and deactivate the option '*Active*'. To permanently delete the reflex suppression areas for one camera, right-click on the respective camera and select '*Delete all reflex suppression areas*' and accept the changes. You can also delete the reflex suppression areas for all cameras at once by selecting '*Delete all reflex suppression areas for all enabled cameras*'.

7.6.2 Inertial Sensor Calibration

This function carries out a drift correction for attached inertial sensors. Please refer to chapter 6.2.4 on page 63 for more information.

7.6.3 Room calibration

Use the room calibration dialogue (see figure 7.21 on page 106) to set parameters of your room calibration hardware and start the calibration process. After opening the dialogue,

the *Monitor 2DOF display* is automatically started in the background. Doublecheck to verify that all markers of the angle are seen by the cameras.



The **SMARTTRACK** is pre-calibrated. You may keep the default orientation and position of the coordinate system as shown in figure 4.5 on page 31. If it is not adequate for your application please choose the appropriate coordinate system and perform a new room calibration using the provided room calibration set.

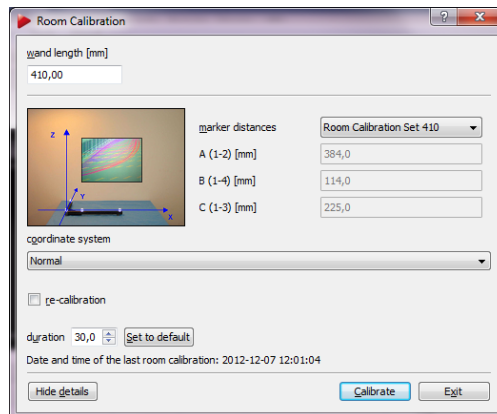

(a) using the Calibration Angle

(b) without Calibration Angle

Figure 7.21: Room calibration settings - SMARTTRACK



It is recommended to perform a room (re-) calibration on a regular basis (e.g. after a certain operating time of the **SMARTTRACK**) and especially if the **SMARTTRACK** was subject to extreme vibrations or changing environmental conditions e.g. due to high or low temperatures).



The **Show details** option offers information about the date of the latest room calibration.

If you would like to recalibrate the **SMARTTRACK** using the default orientation and position of the coordinate system directly select the *coordinate system* → *middle of cameras* using the drop-down menu.

Otherwise either select the calibration set delivered with the **SMARTTRACK** (i.e. a pair of angle and wand representing the **ART** Room Calibration Set RCS 410) using the dropdown-menu *marker distances* or use the *expert* mode.

In any case please verify the wand length or enter it manually in the corresponding field *wand length*. The wand length is printed on a label on the wand. Start the calibration by pressing *Calibrate*. The room calibration is started with five seconds delay.

Expert settings Marker distances of the calibration angle can also be set manually using the setting *marker distances* → *expert*. The numbering of the markers is as seen in figure 7.22 on page 107.

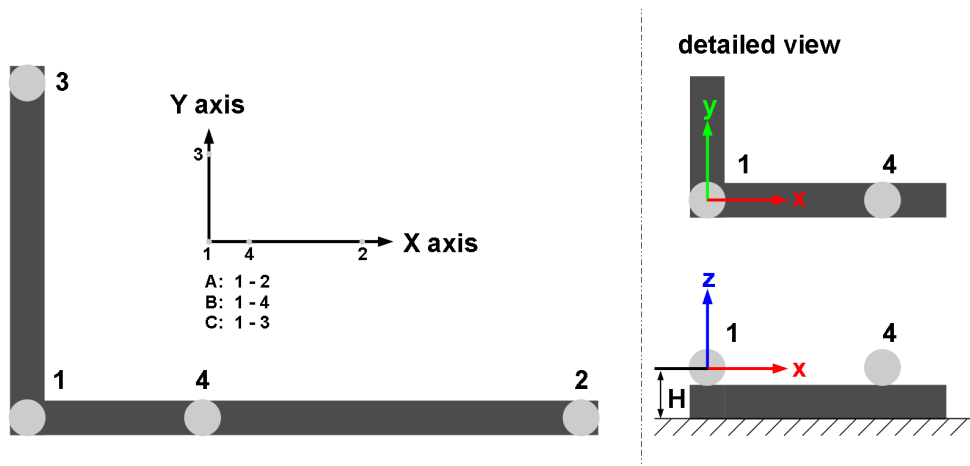

Figure 7.22: Marker distances (including numbering) on the angle and definition of room coordinate system



The longer arm of the angle defines the X axis (refer to figure 7.22); the shorter one the Y axis. The center of marker #1 defines the origin of the room coordinate system (at a height of 43mm).



Incorrect input data for this dialogue will lead to a poor room calibration, to wrong system scaling, or to an abortion of the whole room calibration process.

Coordinate System With the drop-down menu inside the dialogue you may define how the coordinate system of the room is created relative to the calibration angle (refer to table 7.16 on page 108).

If you would like to keep the default orientation and position of the coordinate system of the **SMARTTRACK** please select the *coordinate system* → *middle of cameras*. The calibration angle does not have to be present in the measurement volume; only the wand has to be moved the same way as for a standard room calibration. Otherwise define the *coordinate system* as 'normal' or 'powerwall'.

Duration You may also adjust the 'duration' of the room calibration (→ *Show details*) in a range of 10s - 120s. Resetting the value to default is achieved by pressing the *Set to default* button (default = 30s).

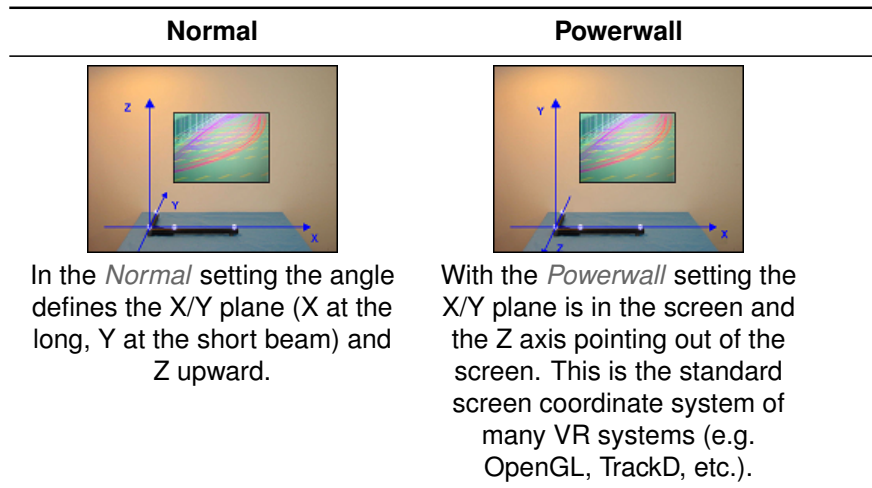



Table 7.16: Defining the coordinate system for the room calibration

 **Changing the duration of the room calibration, especially towards shorter durations, may lead to bad room calibration results! Please make sure that you are always able to cover two thirds of the tracking volume within the set time.**

7.6.3.1 Room Calibration Progress

When the room calibration starts a window showing the progress of the room calibration appears (see figure 7.23(a) on page 108). The progress is shown for each camera which is especially helpful for big systems.

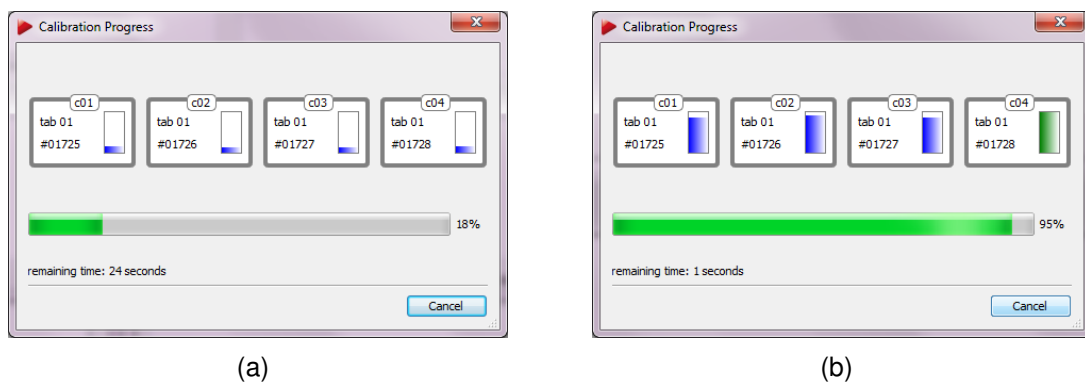



Figure 7.23: Room calibration progress

As soon as the display for a camera changes its colour to green (see 7.23(b) on 108) enough data for calculation of the camera position has been collected for this camera.

 **The point cloud should fill at least two thirds of the measurement volume. Moving the wand in restricted volume will result in reduced accuracy of calibration or failure.**

7.6.3.2 Room Calibration Results

After a successful room calibration, the *DTrack2* info window with the calibration results is displayed. This window shows the mean residuals for the single cameras (here: '*Residual*' = mean residual of rays during marker detection), as well as the mean deviation ('*wand residual*') and the maximum deviation ('*wand range*') of wand length during the calibration process. The value '*Used Frames*' represents the percentage of valid (i.e., used for room calibration) data for each camera.

Try to achieve a low '*mean wand residual*' up to 1 mm for VR installations while having high values for '*Used Frames*'. The number of '*Used Frames*' should be greater than 70% for each camera. Values under 50% indicate poor room calibration quality. The parameters '*Residual*' for each camera and the '*wand range*' depend on the system geometry and give additional information about the quality of calibration. Please call **ART** for further information.

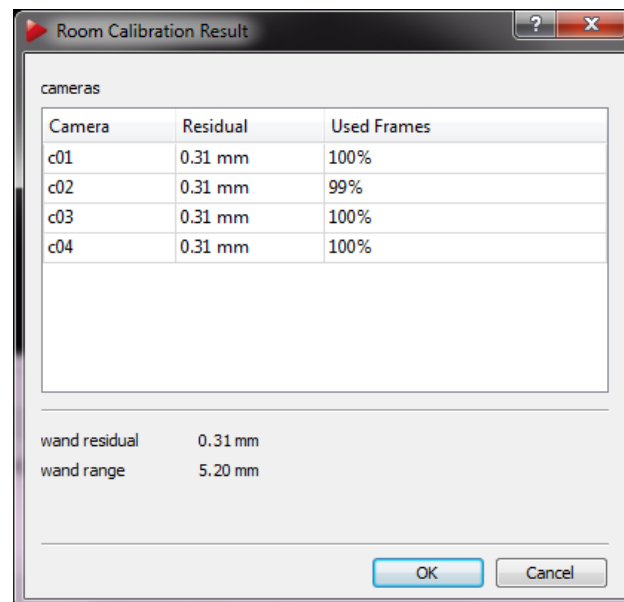

cameras		
Camera	Residual	Used Frames
c01	0.31 mm	100%
c02	0.31 mm	99%
c03	0.31 mm	100%
c04	0.31 mm	100%

wand residual	0.31 mm
wand range	5.20 mm

OK Cancel

Figure 7.24: Room calibration result

The room calibration is confirmed (i.e., the data are stored) by pressing the button *OK*.

7.6.3.3 Room re-calibration

The *SMARTTRACK* setup may change after a certain operation time; if e.g. movement of the *SMARTTRACK* due to mechanical instabilities cannot be ruled out or thermal drifts occur it is necessary to perform room calibrations periodically. *DTrack2* provides a simplified room calibration to revise an existing room calibration without the need of an calibration angle, called room *re-calibration*.

This means no calibration angle has to be present in the measurement volume; only the wand has to be moved the same way as for a standard room calibration. The main ad-

vantage of a room re-calibration is that *DTrack2* preserves the origin of your coordinate system and therefore, the orientation of the coordinate system as well.

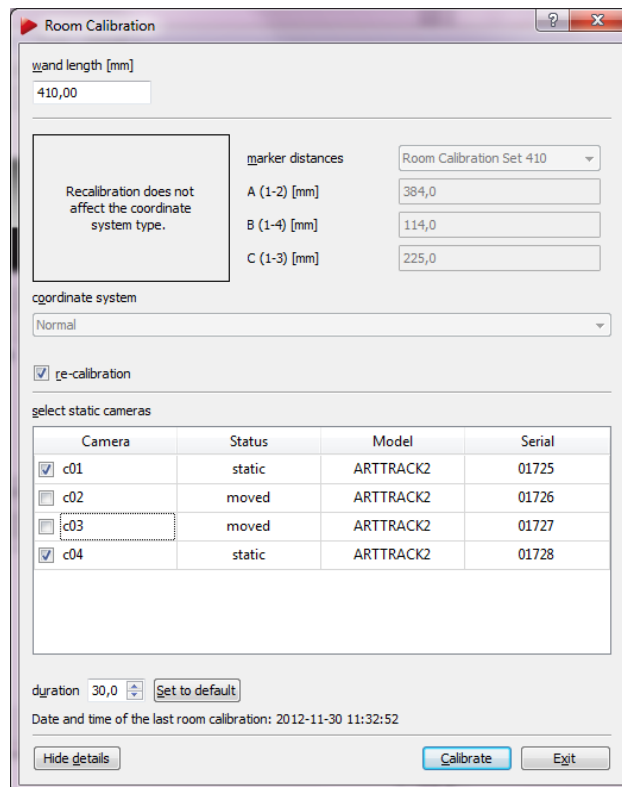

Figure 7.25: Room re-calibration dialogue



Room re-calibration is only applicable when the default orientation and position of the coordinate system of the SMARTTRACK has been changed according to your application (i.e. coordinate system as 'normal' or 'powerwall'.)

To re-calibrate your room tick the checkbox *re-calibration* in the bottom left corner of the room calibration dialogue (see figure 7.25 on page 110). Most settings are greyed out and thus are not allowed to be changed in comparison to the last valid standard room calibration. Settings regarding the wand may be modified, however.

7.6.4 Room adjustment

The *SMARTTRACK* is pre-calibrated. The default orientation and position of the coordinate system is shown in figure 4.5 on page 31. If it is not adequate for your application you can run a room calibration using the provided room calibration set. During this room calibration the reflective marker (marker #1) in the angle's vertex (see figure 7.22 on page 107) defines the origin of the coordinate system. Oftentimes it might be more suitable to set the origin in respect to a well-known point in space. Use this functionality to alter the room coordinate system after calibration.

Possible scenarios for the application of the *Room adjustment* functionality are:

- adjust the origin to the center of a screen,
- align the coordinate system colinear / parallel to a screen (even very small angular deviations might lead to substantial misalignment over the full width of the projection 0.1° on 5m length equals 8.7 mm deviation)
- shift and / or rotate the camera coordinate system to match a reference coordinate system, e.g. from CAD models
- maintaining a specific coordinate system / orientation when using mobile installations of cameras, i.e. frequently changing the camera setup locations (suitable reference points provided)

In all these cases the coordinate system must be altered after calibration.

Coarse The *Coarse* tab offers a simple way to manipulate the orientation of the room coordinate system with just one click (see figure 7.26 on page 111. You can define the orientation of two axes using the drop-down menus - the third one will be oriented automatically according to the right-hand rule.

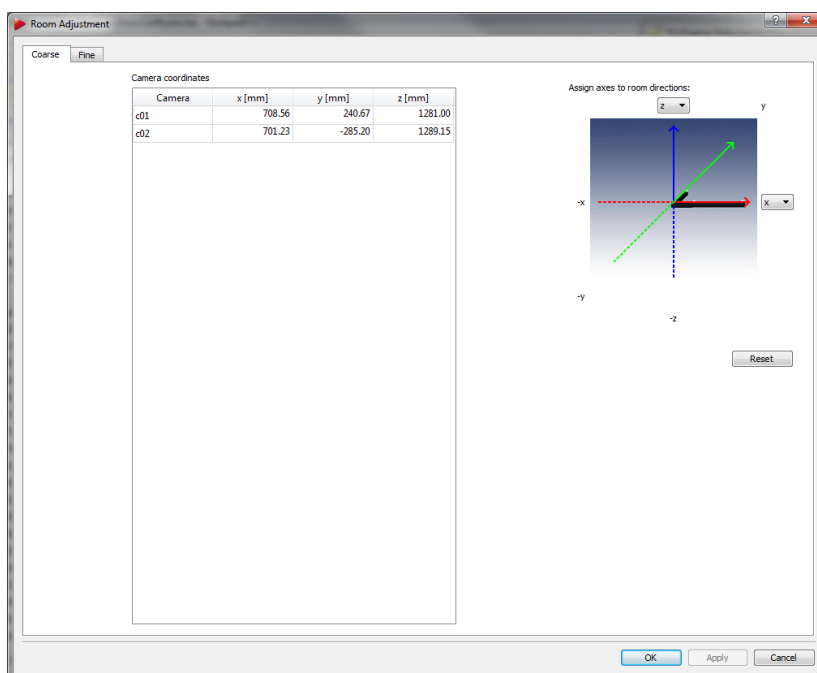

Figure 7.26: Room adjustment dialogue (coarse)



If you press *Enter* or click *OK*, all changes so far will be confirmed (changes are sent to the controller) and the dialogue closes. Pressing *Apply* accepts the current changes, but the dialogue is left open. Discard all changes by pressing *Cancel*. Press *Reset* to switch back to the unmodified state.

Fine More detailed options to adjust the room coordinate system are given in the *Fine* tab (see figure 7.27 on page 112). By default a cartesian coordinate system is displayed on the left side of the window. The room coordinate system is shown as a triplet of arrows with a defined color-coding (x-axis: red, y-axis: green, z-axis: blue), while the xy-plane is shown as a yellow grid. The current and the transformed room coordinate systems are marked with ('O') and ('T') respectively.

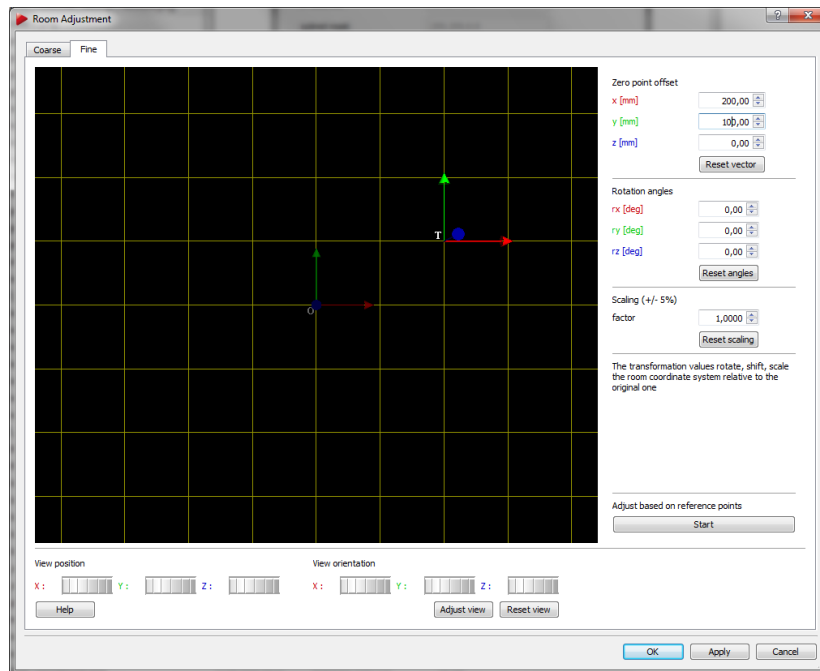

Figure 7.27: Room adjustment dialogue (fine)

The *View position* and *View orientation* may be moved along and / or rotated around all axes in two different ways:

1. hold down the "Ctrl" key and the left / right mouse button to change the position / orientation
2. use the six control dials (below the graphical view) to adjust position and orientation

To center the current room coordinate system, press '*Adjust view*'. To restore the default view (shift and orientation), press '*Reset view*'. The visualisation itself can be changed by clicking the right mouse button to open a menu with the following options. (De-)select the appropriate ones by (un-)ticking.

Option	Description
'Long axes'	extends the coordinate axes of the body coordinate system by infinite dashed lines
'Show XY plane'	shows the XY plane (yellow grid)
'Show YZ plane'	shows the YZ plane (cyan grid)
'Show XZ plane'	shows the XZ plane (magenta grid)

On the right side of the window the room coordinate system may be customized freely, i.e. user-specific.

Action	Description
<i>Zero point offset [mm]</i>	translate the room coordinate system along its axes in steps of 1mm
<i>Reset vector</i>	reset the zero point offset to the unmodified state (0.00 mm)
<i>Rotation angles [deg]</i>	rotate the room coordinate system around its axes (from -180 to +180 °)
<i>Reset angles</i>	reset the rotation angles to the unmodified state (0.00 °)
<i>Scaling factor</i>	enlarge / shrink the room coordinate system uniformly by a factor of +/-5 percent
<i>Reset scaling</i>	reset the scaling factor to the unmodified state (1.0000)
<i>Start</i>	start up a module for transforming & matching to a reference coordinate system (Measurement Tool & license provided)

All entered transformation values are relative to the original room coordinate system, i.e. in a standard coordinate system (xy plane on the ground, z axis facing upwards) the origin is placed 42mm above the ground (due to height of calibration angle + radius of spherical marker). If the new desired origin is to be placed 1 m above the ground, then the *Zero point offset* for z is 958mm (1000 mm - 42 mm).

7.6.4.1 Transform the room coordinate system

Press *Start* in the *Fine* tab to open the room matching dialogue (see figure 7.28 on page 115). This functionality depends on the Measurement Tool license.



If the Measurement Tool is not tracked (calibration provided) matching cannot be performed. Use an authorised Measurement Tool by ART for best results.



Deselect any previously assigned Measurement Tool References prior to matching of the coordinate systems. Otherwise matching results will be erroneous.

The purpose of the coordinate transformation is to convert the origin and orientation of the initial camera coordinate system (indicated with 'O') into a reference coordinate system (indicated with 'T'), e.g. given by a certain object or CAD model. All measurement data will be transformed with respect to the reference coordinate system ('T'). To this end a three-step calibration procedure has to be performed:

1. Add measurement data from the reference coordinate system ('T') by manually entering the coordinates into the table *reference points* using the button *Add*. A minimum of three (3) data points is necessary for calculations. Delete single data points by selecting the corresponding row and press *Remove*. Alternatively load the coordinates from a text file (ASCII) using the button *Load*. The text file must comply to the following format:

7 DTrack2 frontend software

```
1 1.00 20.00 300.00 <CRLF>
2 4.00 50.00 600.00 <CRLF>
3 7.00 80.00 900.00 <CRLF>
# x      y      z      <CRLF>
```

The import strictly follows the sequence from the ASCII text file. Still in some cases the data might be ambiguous regarding its 3-D orientation. Toggle the tickbox *preserve order of points* to lock the order in the table *reference points*. The current set of reference points can be saved by pressing *Save*.

2. Select a calibrated and tracked Measurement Tool from the drop-down menu and measure all points (e.g. on the corresponding object) which directly relate to the reference points (e.g. from a CAD model) defined in step 1.

Each measurement can be started by:

- clicking the button *Measure*
- clicking the start button on the Measurement Tool (if applicable)
- using the start button simulation of the Measurement Tool (refer to 5.4 on page 47)
- clicking a button of an assigned Flystick



For proper matching it is essential to acquire the data points in the exact sequence of the reference data

3. After having measured all corresponding points the calculation is started automatically and the result of the transformation is displayed in the textbox *transformation*. Double-check that all measured data points correspond to the correct reference data points. Delete single data points by selecting the corresponding row and press *Remove* or delete all data points to start all over by pressing *Clear*. The residual error (standard deviation) is a measure of the transformation quality, i.e. how well the measured data fit the corresponding reference points. It can be influenced mostly by the quality of data acquisition and by differences in scale of the camera and reference coordinate systems. Pressing *OK* accepts this transformation and closes the dialogue box.

The calculated transformation is applied on both *zero point offset* as well as *rotation angles* in *Fine* tab. Do not further manipulate the values manually. Press *Enter* or click *OK* to confirm the resulting transformation and to close the dialogue. Pressing *Apply* accepts the current changes and leaves the dialogue open. Discard all changes by pressing *Cancel*.

7.6.5 Body calibration

7.6.5.1 Body calibration overview

The process of teaching a target's geometry to the tracking system is called body calibration. For a body calibration, the target (= rigid body) to be calibrated has to be in the field

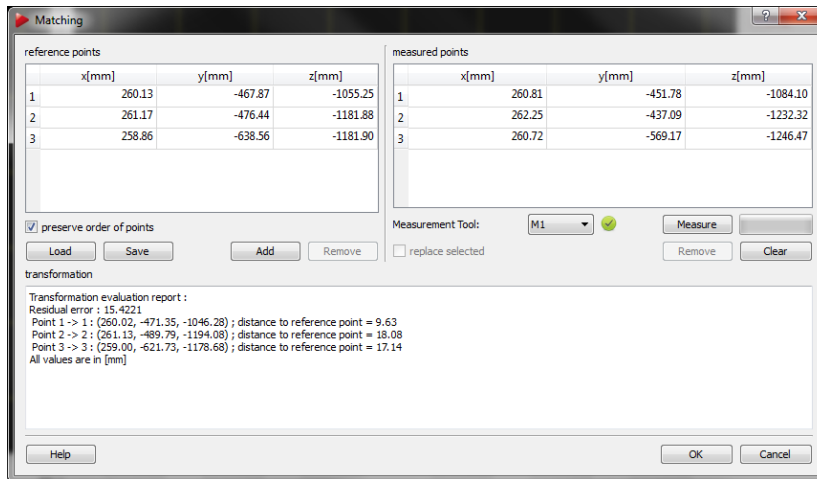
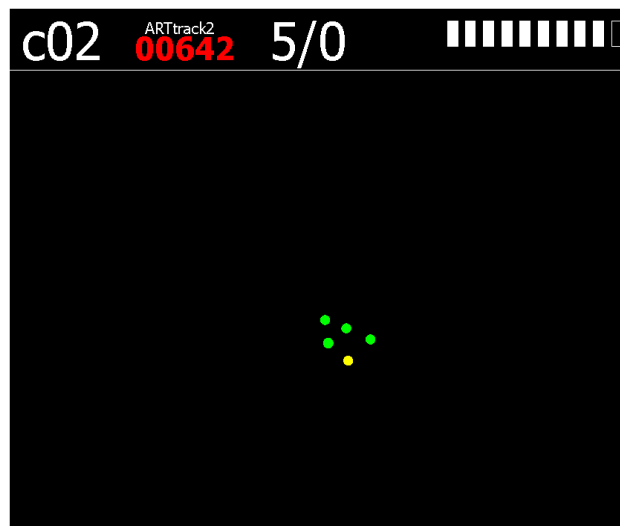

Figure 7.28: Room transform & matching dialogue

of view of the IR cameras.

The body can be moved during body calibration, always considering that the cameras should see each marker of the body at the best.

If two markers, seen from one camera's point of view, are merging to one reflection, body calibration may be affected. These "merging marker situations" should be avoided during body calibration, i.e. the target should be oriented in a way that reduces merging markers to a minimum. The target orientation can be checked using *DTrack2's Monitor 2DOF display*, which is opened automatically in the background after starting the body calibration. The following figure 7.29 on page 115 shows a rigid body with five markers that are all correctly seen by the IR camera.

Figure 7.29: Recognized target in *DTrack2 Monitor 2DOF display*

Furthermore, the absence of any additional markers in the measurement volume has to be ensured for body calibration. If additional markers that are not part of the target to be calibrated are in the field of view of the IR cameras during body calibration, these mark-

ers will be assigned to the target. That means, the target is not correctly calibrated and, therefore, tracking problems may occur.

7.6.5.2 Body calibration procedure

Open the dialogue *Calibration* → *Body* to start a body calibration .

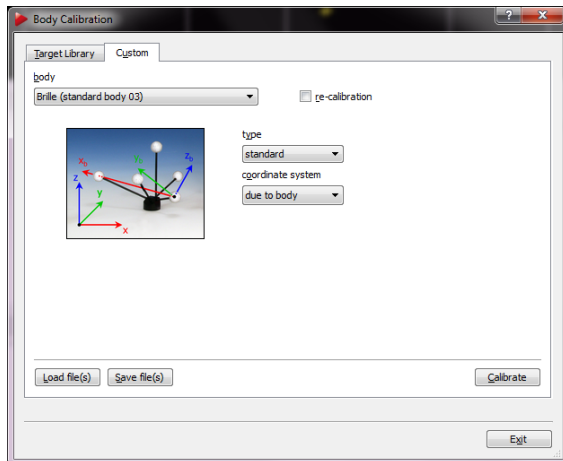

(a) Target type "standard"

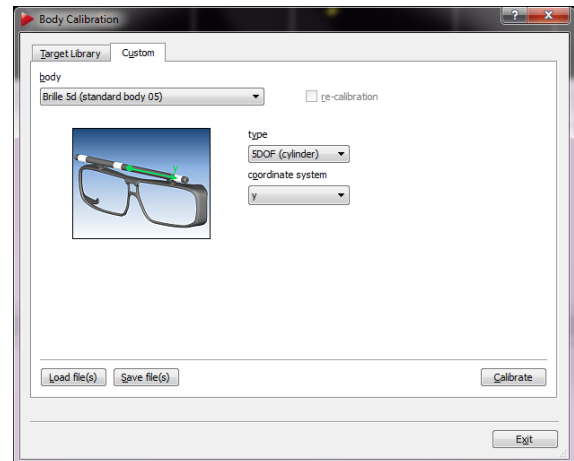

(b) Target type "5DOF"

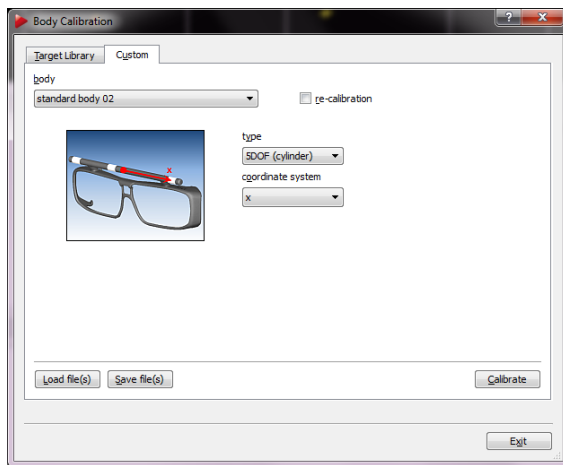

(c) Target type "5DOF (cylinder)"

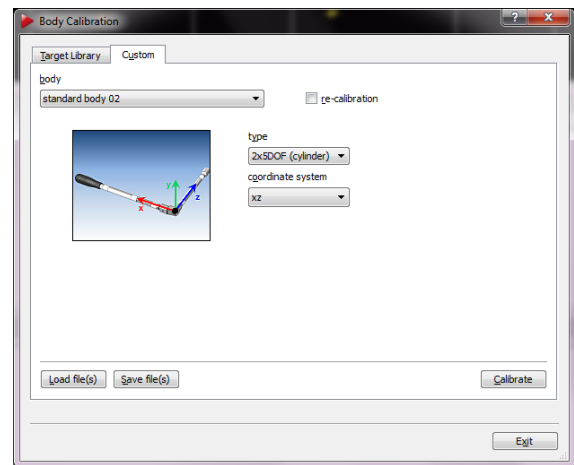

(d) Target type "2x 5DOF (cylinder)"

Figure 7.30: Body calibration dialogue

First, the target that shall be calibrated has to be selected in the select list *Body*. By default the *type* is set to 'standard' which allows for calibrating a 6DOF target with spherical, flat or active markers. When you are using a target made of ring markers you would select the '*type*' according to the geometry of the target:

- '*5DOF*' .. a target made of spherical markers which are aligned along one main

axis. The rotation around that axis cannot be detected by the system - you lose one dimension of freedom. Therefore, we call it 5DOF target.

- '5DOF (cylinder)' .. a target made of ring markers which are aligned along one main axis.
- '2x 5DOF (cylinder)' .. an L-shaped target made of ring markers which delivers 6DOF data.

To re-calibrate a body tick the checkbox *re-calibration* next to the drop-down menu. For more information about body re-calibration please refer to chapter 7.6.5.7 on page 121. After pressing *Calibrate*, the body calibration is started within five seconds delay.



After a new room calibration or room re-calibration it is not necessary to perform a new body calibration. Only if the body itself changes you have to calibrate the body again.



The previous body calibration will be lost if you carry out a new body calibration. If you want to save the previous body calibration please use the 'Save file(s)' option in the *Body calibration* dialogue.

7.6.5.3 Body calibration result

After successfully calibrating a body a result window is displayed (see figure 7.31 on 117).

Figure 7.31: Body Calibration Result



Please double-check whether all markers of the rigid body have been recognized.

Double-check whether all markers of the rigid body have been recognized. Then, confirm the result with *OK*. The information (i.e. geometry data) of the calibrated target will be stored inside the **ART** Controller in your personal configuration (see also 7.4.2 on 87).

7.6.5.4 Selecting the coordinate system for 6DOF targets

The type of body calibration can be set as '*due to body*', '*due to room*' or '*due to room (zero in marker)*'. The difference between these calibration types is to be found in the orientation of the body coordinate system relative to the body. During body calibration, **DTrack2** defines a local coordinate system (body coordinate system) for each target.

Body calibration setting due to body The body coordinate system is fixed by the markers of the rigid body according to a set of rules:

1. Search the biggest distance between two markers of the rigid body. These two markers (# 1 and # 2) will define the X axis.

2. Search for a third marker (# 3) that has the smallest distance to one of the two markers # 1 and # 2. The marker that has smallest distance to marker # 3 becomes marker # 1. It will define the coordinate origin. The other marker will be # 2. The positive X axis is directed from marker # 1 to marker # 2.
3. Marker # 3 defines the X/Y plane, together with markers # 1 and # 2. Marker # 3 has a positive Y coordinate.
4. The Z axis is already defined by these rules, resulting in a right-handed coordinate system.

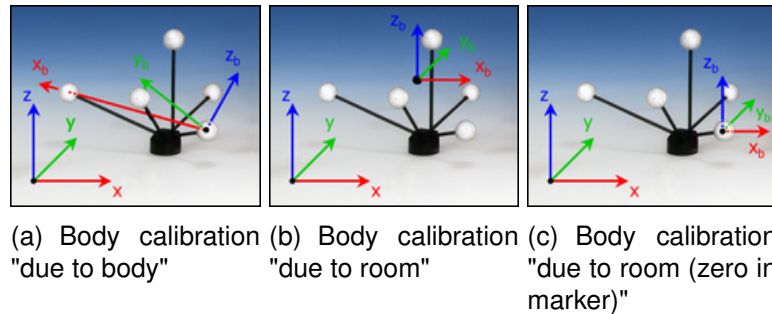

Figure 7.32: Defining the target coordinate system

Body calibration setting due to room The origin of the body coordinate system is set to the center (center of gravity) of all markers building the rigid body. The axes of the body coordinate system are parallel to the axes of the room coordinate system in the beginning of the body calibration. I.e., the result of a body calibration will depend on the angular position of the target during calibration. A 6DOF measurement, following calibration without having moved the body, will give the angular coordinates $0^\circ / 0^\circ / 0^\circ$. If the target was moved during calibration, the angular position of the target at the beginning of the calibration will be taken.

Body calibration setting due to room (zero in marker) A combination of the first two methods. The direction of the axes of the body coordinate system will be set parallel to the room coordinate system in the moment of body calibration - like done with setting due to room. The origin of the body coordinate system is given by one marker of the body, according to the rules given for setting due to body.

7.6.5.5 Selecting the coordinate system for 5DOF targets

Analogue to the settings for the standard targets it is also necessary to define the body's coordinate system in case of 5DOF targets. For these bodies the rotation around the body axis cannot be measured by the tracking system. Thus, the 5DOF central axis is important if you intend to use the rotation around the body axis. The most important properties are:

- If the 5DOF body is positioned parallel to the 5DOF central axis the rotation around the body axis remains undetermined.
- The rotation around the body axis is reduced to a minimum.

We recommend that you choose the 5DOF central axis according to a direction which is the least often parallel to the tracked body axis (e.g. floor to ceiling for glasses targets). Please refer to chapter 7.5.5 on page 94 to select the central axis in the menu *Settings* → *Tracking*.



The best choice for the 5DOF 'central axis' may be found when using the tracking data in your application.

Details of the definition: In addition to the 5DOF central axis the system selects an axis for each body in the body coordinate system (i.e. "pulled axis"). The rotation around the body axis is set to the value minimizing the angle between the pulled axis and the 5DOF central axis. The pulled axis is always perpendicular to the body axis. In addition the following criteria are used:

- If the 5DOF central axis is not the body axis the pulled axis is the axis minimizing the angle to the 5DOF central axis.
- If the 5DOF central axis is the body axis the pulled axis has a random direction in the plain.

Coordinate system setting for type '5DOF' and '5DOF (cylinder)' In this body coordinate system all markers of the target are on the selected axis. The origin is in the middle between the two markers with the largest distance to each other. The orientation is defined by the marker with the smallest distance to the origin. Its position has a negative sign. The other two directions are undetermined due to the one degree of freedom.

Coordinate system setting for type '2x 5DOF (cylinder)' The body is expected to consist of two connected 5DOF targets with a roughly perpendicular and constant angle in between. These are placed on the two axes. The origin is placed at the position where the two 5DOF targets intersect. The first axis is assigned to the 5DOF target which includes the marker with the largest distance to the origin. The other 5DOF target is placed in the plane created by the two axes.

A click-type torque wrench is one the most prominent members of this class of bodies. Due to the engineering backlash and other high mechanical tolerances in these devices often times the resulting body calibrations are error-prone.

7.6.5.6 Calibration with a calibration file

To easily create backups of calibrated bodies, calibration files can be saved at a desired location on the remote PC. These files contain the dimensions of the target and the distances between all markers. Each file is specific for just one type of target.

7 *DTrack2* frontend software

Just click *Load file(s)* and select the appropriate calibration file(s) or click on *Save file(s)* respectively.

Press '*Save file(s)*' option in the *Body calibration* dialogue to store the calibration file(s) of the currently used bodies.

You can also load calibrations . Press *Load file(s)* (see figure 7.33) and choose the calibration file(s) for your targets. The format of the file name has to be according to "*standard b01.txt*" - the identifier "*b01*" refers to the ID of the target. *DTrack2* automatically assigns the calibration file to the respective target by using the identifier in the file name. Press '*Load*' again to confirm the import of the body calibration files.

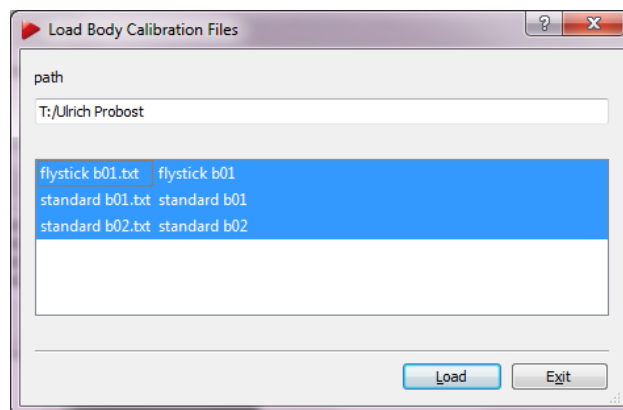

Figure 7.33: Import of calibration files



The previous body calibrations will be lost if you load new calibration files.



Invalid or corrupt files are not loaded by *DTrack2* . This is indicated by an error message in the confirmation dialogue.

In the upcoming window (see figure 7.31 on page 117) the coordinates of all identified markers are listed together with the body's label as well as the number of markers. It is analogue to the body calibration result.

By clicking *Show details* additional information can be displayed.

- '*Distances*' shows all possible combinations of distances for all markers (min. distances are important for customer-specific geometries, call **ART** for further information)
- '*Emissions*' shows normalised emission vectors x, y, z and emission aperture for bodies with restrictions of visibility (calibration files available on request by **ART**)
- '*Cylinder*' shows coordinates and radii for bodies with (cylindrical) ring markers

Restricted Visibility / Emission Cones Optionally a restricted visibility can be defined for each marker of a body. This is performed setting up so called 'emission cones'; in essence, a 2DOF observation from a camera has to be inside this cone so that tracking data can be used later for pose estimation. Currently the only way to equip markers with emission cones is to import an appropriate calibration file which are available on request. These files are created at **ART** on site performing a body calibration in a defined environment or measurement volume respectively.

7.6.5.7 Body re-calibration

DTrack2 provides a possibility to re-calibrate a rigid body in case its geometry is affected due to e.g. mechanical impact. Tick the checkbox *re-calibration* and perform a routine body calibration as described in 7.6.5 on page 114.



Only during a re-calibration the origin and orientation of the initial coordinate system, as well as specific information (predefined emission vectors, cylindrical marker) are preserved.

7.6.5.8 Target Library

With the introduction of **DTrack2** v2.8.1 it is possible to make use of an integrated library that contains calibration data for most **ART** standard targets (e.g. Motion Capture, glasses targets, etc.). When you go to *Calibration* → *Body* choose '*Target Library*' (refer to figure 7.34). The filter is set to '*Found Targets*' by default whereas the other options may be used in case only targets of this type are to be calibrated (e.g. Motion Capture).

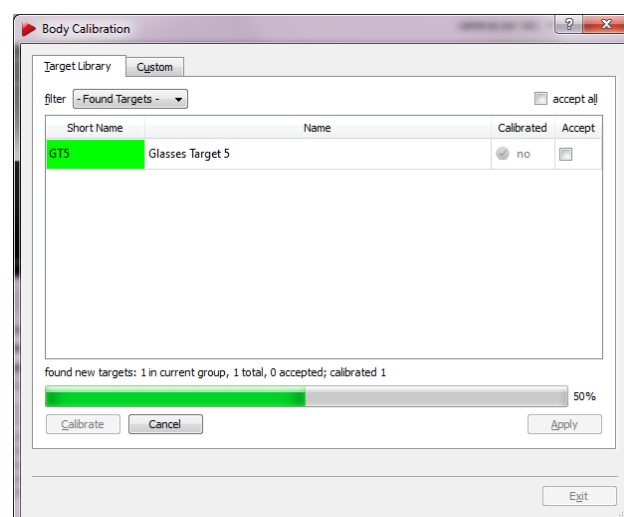

Figure 7.34: Calibrate bodies with the target library

With the '*Found Targets*' filter all targets presented, i.e. shown to the system, will be found. In the unlikely case that a target is not found by the system it needs to be cal-

ibrated using the standard body calibration. The calibrations for all found targets only need to be accepted either by ticking the checkbox '*accept all*' or one at a time. Finalize the assignment of the targets by pressing '*Apply*'.



***DTrack2* compares the geometry of the physical target with the calibration data of the target library. In some cases a re-calibration might be necessary, e.g. when a clip-on target is applied to the glasses bending is possible.**

If you haven't increased the number of targets before the system will ask you if this number should be adjusted automatically. Press '*OK*' if you want the system to do so.

First, make sure that all targets are in the calibrated volume. Then, start the calibration (*Calibration* → *Body* → '*Target Library*' → '*Calibrate*') and allow the targets to move around. While this movement the targets must be visible to the **SMARTTRACK**.

Finally, one after the other target should be recognized and appear in the display. Tick the checkbox '*accept all*' and start the measurement in order for your application to receive tracking data.

In case you need to adjust the order of the targets please go to *Settings* → *Body Administration* (F8).

7.6.6 Body adjustment

The *Body adjustment* function is a tool to visualise and manipulate calibration data of rigid bodies, i.e. the body coordinate system may be changed relative to the markers of the body. Just select the desired body from the drop-down list at the top of the window (see figure 7.35 on page 123).



Body adjustment is not available for 5DOF targets or measurement tools.

The main features of *Body adjustment* are:

- adjust the body coordinate system of each target within the ***DTrack2*** frontend,
- online mode (i.e. the 3D-representation of the target in the '*Graphic view*' is depicting movements / rotation of the target in the "real world"),
- visualise (optionally) predefined emission cones due to restrictions of visibility (directional and angular dependence) for all markers
- aligning the axes of body and room coordinate system without changing the origin,
- use predefined body coordinate systems,
- move the origin of the body coordinate system,
- set the origin of the body coordinate system in a selected marker,
- delete selected markers from the target geometry.

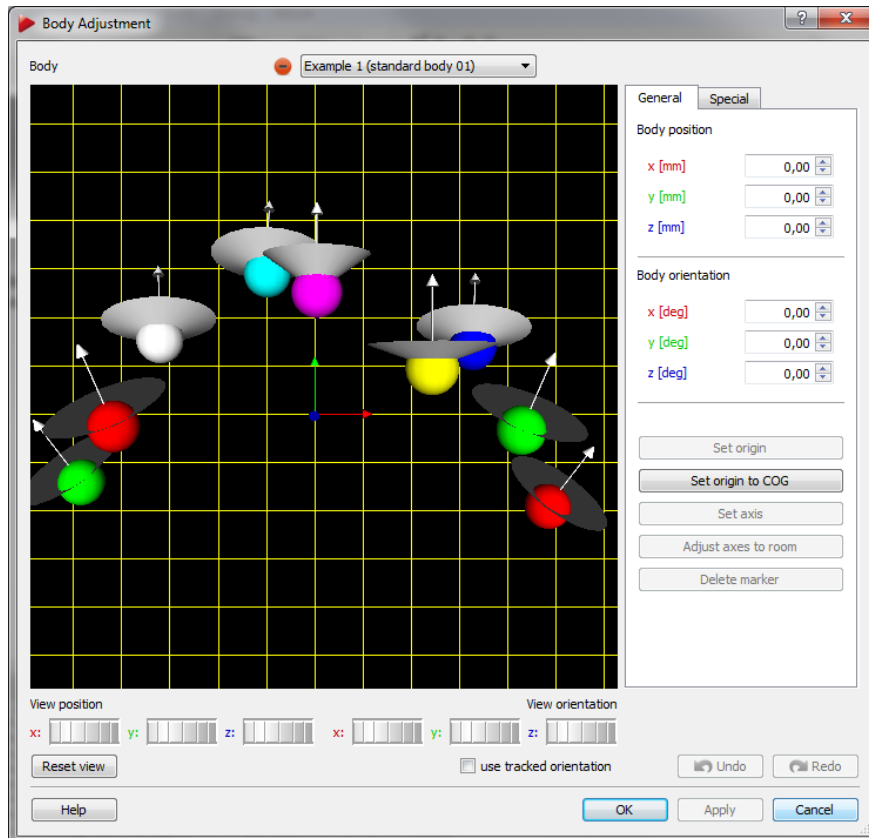

Figure 7.35: Body Adjustment

7.6.6.1 Graphic View

By default a cartesian coordinate system is displayed on the left side of the window depicting the selected rigid body's geometry ('*Graphic view*'). On the right hand side the body's coordinate system can be manipulated. The body coordinate system is shown as a triplet of arrows with a defined color-coding (x-axis: red, y-axis: green, z-axis: blue), while the xy-plane is shown as a yellow grid. All markers, however, are visualised by sequentially colored spheres (RGB) for better identification. In case the selected rigid body features visibility restrictions, emission cones may have been predefined. Direction of visibility (emission vector) is depicted as an arrow (white) for each marker, while the angular restriction (emission aperture) is shown as a cone (grey).

The *View position* and *View orientation* may be moved along and/or rotated around all axes in two different ways:

1. hold down the "Ctrl" key and the left / right mouse button to change the position / orientation
2. use the six control dials (below '*Graphic view*') to adjust position and orientation

To restore the default view, just press '*Reset view*'. Tick the '*use tracked orientation*' checkbox to switch to online mode (i.e. the 3D-representation of the target in the '*Graphic*

view' is depicting movements / rotation of the target in the "real world").

The visualisation can be changed by clicking the right mouse button to open a menu with the following options. (De-)select the appropriate ones by (un-)ticking.

Option	Description
'Small markers'	reduces the size of the markers
'Colored markers'	shows the markers in different colors (untick: greyish)
'Emissions'	shows predefined direction (arrows) and angular restriction (cones) of visibility (if applicable)
'Long axes'	extends the coordinate axes of the body coordinate system by infinite dashed lines
'Show COG'	shows the body's center of gravity (white square)
'Show XY plane'	shows the XY plane (yellow grid)
'Show YZ plane'	shows the YZ plane (cyan grid)
'Show XZ plane'	shows the XZ plane (magenta grid)
'Show room orientation'	shows the room coordinate system (only available when checkbox 'use tracked orientation' is ticked)
'Add line between markers'	adds a line between two selected markers (option greyed out until two markers are selected)
'Delete line between markers'	removes a line between two selected markers (option greyed out until line is selected)
'Data view'	switches to the data view

7.6.6.2 Changing of body geometry

For manipulating the body geometry you have the choice between *General* or *Special* options:

General The body coordinate system may be customized freely, i.e. user-specific.

Action	Description
<i>Body position [mm]</i>	translate the body coordinate system along its axes in steps of 1mm
<i>Body orientation [deg]</i>	rotate the body coordinate system around its axes
<i>Set origin</i>	activate a marker in the ' <i>Graphic view</i> ' by left-clicking with the mouse. The marker is highlighted and the button <i>Set origin</i> is activated. Pressing this button translates the origin of the body coordinate system into the center of the selected marker.
<i>Set origin to COG</i>	translate the origin of the body coordinate system into the target's center of gravity
<i>Set axis</i>	activate two markers sequentially in the ' <i>Graphic view</i> ' by left-clicking with the mouse. The first one is highlighted in white, the second one in grey. Additionally, the button <i>Set axis</i> is activated. Pressing this button opens a dialogue to configure the transformation.
<i>Adjust axes to room</i>	pressing this button aligns the body coordinate system collinear to the room coordinate system
<i>Delete marker</i>	activate a marker in the ' <i>Graphic view</i> ' by left-clicking with the mouse. The marker is highlighted and the button <i>Delete marker</i> is activated. Pressing this button removes the selected marker from the target geometry.

Special Choose from the following predefined transformations:

- *due to body*
The body coordinate system is completely defined by the target geometry (see page 117).
- *due to room (origin in COG)*
The coordinate system is rotated and aligned collinear to the room coordinate system with the origin set in the center of gravity (COG) (see page 118). In order to use this function, the checkbox '*use tracked orientation*' has to be ticked.
- *due to room (origin in marker)*
The coordinate system is rotated and aligned collinear to the room coordinate system with the origin set in one specific marker (see page 118). In order to use this function, the checkbox '*use tracked orientation*' has to be ticked.



Predefined visibility restrictions (emission vectors and angles of aperture) are retained along all body transformations.



Whenever you press *Enter* or click *OK*, all changes so far for all bodies will be confirmed (changes are sent to the controller) and the dialogue closes. Pressing *Apply* only results in changes of the currently selected body - the body will be redrawn afterwards and the dialogue is left open. Discard all changes by pressing *Cancel*. Press *Reset* to switch back to the unmodified state.



If the *MultiUser* function for *Flysticks* is enabled the *Body Adjustment* module will only load standard bodies. If you want to adjust the body calibration data of your *Flystick*, please make sure that the *MultiUser* function is disabled (*Settings* → *Flystick*) - a label '*MultiUser function should be disabled!*' will appear at the bottom of the dialogue.

7.6.7 Hybrid Body Calibration

This function performs a hand-eye calibration to combine an inertial sensor with its corresponding optical target. Please refer to chapter 6.2.3 on page 61 for more information.

7.6.8 Measurement Tool Calibration

Perform a tip calibration for the Measurement Tool that is currently inside the tracking volume. Please refer to chapter 5.4.1 on page 48 for more information.

7.7 Menu Display

Monitor 2DOF The *Monitor 2DOF display* is a graphical display of the field of view of the cameras to visualise all markers that are seen by the cameras. It is activated by default. A more detailed description can be found in chapter 7.3.3.1 on page 81.

Display	<i>Shortcut</i>
<i>Monitor 2DOF</i>	
<i>Data</i>	F10
<i>Fingertracking</i>	
<i>Flystick</i>	
<i>Measurement Tool</i>	
<i>Events</i>	
<i>Set to default</i>	

Table 7.17: Menu *Display*

Data On the left hand side the *Data Display* shows the 6DOF measurement results (i.e. position and orientation of the body relative to the room coordinate system). Additional information for inertial sensors are also shown, if applicable. On the right hand side the results for 3DOF calculation of single markers (e.g. from not calibrated targets) is shown, if activated.

Flystick The *Flystick* display shows the measurement results of the position and orientation of the Flystick.

Measurement Tool The *Measurement Tool* display display shows the measurement results of the position and orientation of the Measurement Tool .

Events The *Event Display* shows the status of the tracking system. All messages and entries shown here are also stored in event logs on the remote PC. These files are necessary for tech support by **ART** (please refer to chapter 7.4.2 on page 87).

Set to default This function resets the appearance of the *DTrack2* frontend, i.e. all views and the size of the windows are reverted to default values. Only the *Monitor 2DOF* and the displays *Data* and *Events* are shown.

7.8 Menu Tools

Tools	<i>Shortcut</i>
<i>Controller Update</i>	
<i>Measurement Tool Demo</i>	

Table 7.18: Menu *Tools*

7.8.1 Controller Update

After updating the *DTrack2* frontend software the controller and cameras are updated automatically, if necessary. In case you aborted this process you can re-open the update assistant by clicking *Tools* → *Controller update*.

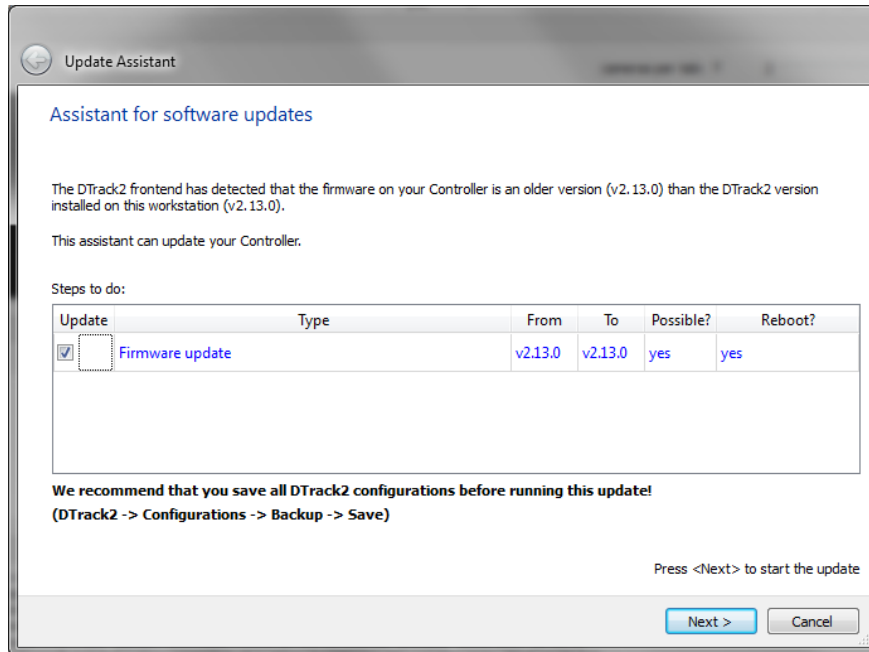

Figure 7.36: Update Assistant

An assistant (see figure 7.36 on page 127) will start up to guide you through the process of software update. Closely follow the instructions given during this process. The controller will be restarted to finish the update process.

In case of firmware updates the cameras need to be turned off separately. You can always abort the update by cancelling.



Personal settings and configurations (e.g. room and body calibration, output settings, etc.) will be preserved during update!

7.8.2 Measurement Tool Demo

This demo (see figure 7.37 on page 128) provides a simple acquisition tool to perform measurements with the Measurement Tool . Up to four Measurement Tool devices are supported.

The measurement of a point is started either by pressing the button *Measure point* performing a gesture with the Measurement Tool . Tilt over the Measurement Tool as defined in 7.5.9 on page 101.

The distances between adjacent points are computed automatically. You may insert or delete points from the list and you may save the list to a file.

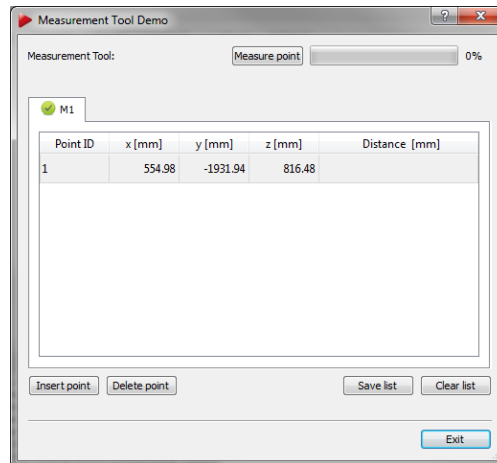

Figure 7.37: Measurement Tool Demo

Control	Description
<i>Measure point</i>	Place the Measurement Tool at the position you want to measure and press this button.
<i>Insert point</i>	Add an additional measurement to the list (above the selected point).
<i>Delete point</i>	Remove the selected measurement from the list.
<i>Save list</i>	Export the list of measurements to a file (e.g. for import in a spreadsheet program).
<i>Clear list</i>	Delete all entries of the list.



If the Measurement Tool is not tracked a measurement cannot be performed!

7.9 Menu About

About	Shortcut
<i>DTrack2</i>	
<i>About Qt</i>	
<i>What's new?</i>	
<i>What's this?</i>	Shift + F1

Table 7.19: Menu *About*

DTrack2 Offers information about the software version and release date of the *DTrack2* frontend software and backend software running on the controller (see figure 7.38 on page 129). Additionally name and serial number of the controller are shown. By clicking on the button *Show details* a list of all included software modules is shown together with their respective software versions. Information regarding licensing of *DTrack2* can be found under *Open-Source software*.

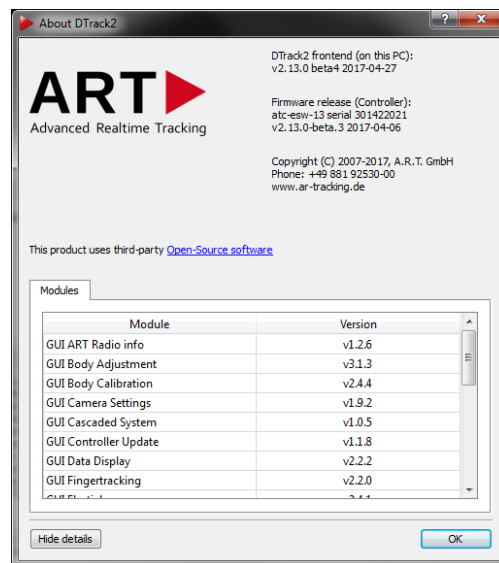

Figure 7.38: About DTrack2 Information

About Qt Offers information about the Qt software toolkit used in *DTrack2* .

What's new? Provides information about the new features that have been released with the current version. By clicking on '*Show more*' you can access the history of introduced features in previous versions (see figure 7.39 on page 129).

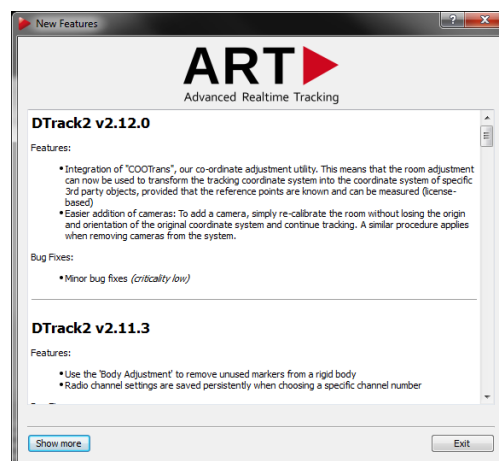

Figure 7.39: What's new Information

What's this? By clicking *What's this*, you may use our context-sensitive help function within *DTrack2* frontend software. Just point the mouse cursor on any feature of the *DTrack2* GUI, then click on the left mouse button to receive additional information.

8 Frequently asked questions (FAQ)

Within this FAQ chapter we are offering solutions for easy-to-solve questions that our support encounters from time to time. The questions are grouped into specific topics to make it more convenient for you to find a solution.

In case you do not find a proper solution for your specific problem, please do not hesitate to contact us.

Our goal is to offer the best support possible. Therefore, we ask you to have the system running and that you have internet access when you call us. Additionally we will need details about your system. Please refer to chapter 7.4.2.2 on page 88 for details how to export a system information file. Please include it in your mail when you contact tech support.

8.1 Backup

⇒ How do I create a backup of important configurations?

From *DTrack2* v2.8.1 it is possible to export and import configurations. Please refer to chapter 7.4.2.1 on page 88 for details how to export and backup your configurations. In case of an accidental deleting of a configuration it will be possible to restore it presuming that an export had been carried out before. In the unfortunate event of repairs this data could also be restored to a replacement controller.

Please note that a room (re-)calibration might be necessary especially in case the amount of cameras or the camera models have changed.

8.2 Cameras

⇒ One of my cameras recognizes a reflection which I can't eliminate. What can I do?

You may enable the suppression of static reflexes within *DTrack2* . But carefully read the notes in chapter 4.1.5 on page 30.

8.3 Controller

⇒ What are the possibilities to start the controller?

The controller is equipped with a switch that you have to press for the initial start-up. If you want to power up your controller remotely, you may either use Wake On LAN (WOL) or wake-on-power (WOP).

⇒ I cannot find my controller. What can I do?

- Please make sure that the controller is connected properly to the Ethernet network.
- Switch on the controller.
- It is possible that your controller has become unreachable due to wrong IP settings (wrong IP address or IP address area, etc.). Please refer to chapter 7.2.4 on page 73.
- In case you are using a firewall, please do not block *DTrack2* communication.

For more information, please also refer to chapter 7.2 on page 70.

⇒ What is the IP address of my controller?

You may use a standard USB pen drive and plug it in to the controller at any time. If not running yet, please switch on the controller. Its settings (IP address, etc.) will be saved to a setup file on the USB stick. This file may be opened and modified in any editor.

Please refer to chapter 7.2.4.1 on page 74 for more information.

⇒ How can I assign a specific IP address to my controller?

You may configure a static IP address the following ways:

- using *DTrack2* (refer to chapter 7.2.2 on page 71)
- without the *DTrack2* frontend (refer to chapter 7.2.4 on page 73)

8.4 *DTrack2* and shutter glasses

⇒ What types of shutter glasses can be used with the *ART* tracking system

- RealD CrystalEyes 1, 2, 3 and 5
- NuVision APG6000 and APG6100
- XPand X101, X103 (with NuVision Long-Range Emitter), X104LX

8 Frequently asked questions (FAQ)

- NVidia 3D Vision Pro (RF sync'ed)
- Volfoni EDGE (with Volfoni or NuVision LR Emitter)
- Virtalis ActiveWorks 500

⇒ **When I start tracking, the shutter glasses don't work correctly.**

Most shutter glasses use infrared signals to synchronize the glasses with the image. The tracking cameras produce a strong infrared flash, which interferes with this communication. By synchronizing both systems, the cameras emit their flash in a way that does not interfere.

Please refer to chapter 4.2 on page 33.

⇒ **When I connect the "ExtIn", the shutter emitters stop working.**

Some projectors create only a weak sync signal (TTL), which is not strong enough to drive the SyncCard2. Please contact **ART** to get a special high-impedance version or synchronize against the video signal (if available).

⇒ **Tracking stops when no stereo image is displayed**

Some graphics adapters only create the shutter image when a stereo image is displayed. If available, use video synchronization. Known behavior for NVidia adapters.

8.5 *DTrack2* and interfaces

⇒ **I'm using VRPN. Which output identifiers have to be activated?**

It is absolutely mandatory that you activate at least the '6d' and '6dcal' output identifiers (refer to table 7.14 on page 100). Activate other output identifiers depending on your application (e.g. if you're using a Flystick you have to activate '6df2').

⇒ **I'm using VRPN and TrackD but I only succeed in receiving data via just one of them.**

Please make sure that you are using two separate output channels with different port numbers.

⇒ **I'm having problems with the Flystick2 or Flystick3 data transmission via TrackD.**

Please make sure that you are using the latest version of the TrackD module - **ART** will provide information upon request. Versions of trackd 5.5 which are older than February 2007 do not support data transmission for Flystick2 or Flystick3.

If you don't want to change the module you may also use the '*old output format*' of Flystick1. Please refer to chapter 5.3.2 on page 45 for more details.

8.6 Software *DTrack2*

⇒ Where do I get the software *DTrack2* from?

The software *DTrack2* is delivered on a USB flash drive with the tracking system. Furthermore, you may register for the **ART** Download Center (<http://www.ar-tracking.com/support/>) in order to always have access to the latest release of *DTrack2*.

⇒ Why is my frontend not starting up?

- Please refer to chapter A.3 on page 153 for a list of supported operating systems.
- If using Windows XP: This is no longer supported as of *DTrack2* 2.13.0. Please update to Windows 7 or newer.
- If using Linux: some newer Linux distributions do not install the library `libpng12.so.0` by default, although it is part of the distribution. Please install it using an appropriate package installer.
- If using 64-bit Linux: please be sure, that you have installed the 64-bit *DTrack2* package. To run 32-bit *DTrack2* on 64-bit Linux, you might have to install the 32-bit version of several libraries (depending on your Linux distribution).

⇒ Some of my menu items are missing. What can I do?

- Please check if the latest updates for your operating system are installed.
- Please refer to chapter A.3 on page 153 for a list of supported operating systems.

⇒ Where is the Monitor 2DOF display?

- Please check if the latest updates for your operating system are installed.
- Please make sure that your firewall is not blocking *DTrack2*, even partly.
- Please refer to chapter A.3 on page 153 for a list of supported operating systems.

⇒ Why does the “(re-)calibration required” message appear in Monitor 2DOF?

- Please make sure you have performed a correct room calibration using all connected cameras.

8 Frequently asked questions (FAQ)

- Please refer to section 7.3.3.1 on page 81 for more information about Adding / removing cameras.

⇒ **My target is not visualized within the Monitor 2DOF display.**

- Please make sure that the target is inside the tracking volume and within tracking range of the cameras.
- Double-check the settings for the flash intensities of the cameras (refer to chapter 7.5.1 on page 90).
- In case you are using active targets, please make sure that you have activated the modulated flash. Please refer to chapter 5.2.4 on page 44 for further details.

⇒ **How do I define the number of targets to be tracked?**

Go to *Settings* → *Body Administration* and change the '*number of 6DOF bodies*'. Please refer to chapter 7.5.6 on page 95.

⇒ **What is the maximum number of targets?**

The maximum number of targets (including Flysticks and Fingertracking hand devices) is depending on the license type:

- Basic and Extended license: 4
- Full-featured license: 50

Starting with *DTrack2* version v2.10 a new license model has been established. You may activate and calibrate 4, 10, 30 or up to 50 targets depending on the license purchased.

Please refer to table 7.6 on page 86 for a complete license overview.

⇒ **Where do I get a license code from?**

You may purchase additional licenses for your system. Please contact us in case you need consultation.

Go to *DTrack2* → *Licenses*.

Please refer to chapter 7.4.1 on page 86 for further details.

⇒ **Where do I enter a new license code?**

Go to *DTrack2* → *Licenses* and enter the code in line '*new license code*'.

Please refer to chapter 7.4.1 on page 86 for further details.

⇒ **Where do I get a software update from?**

The latest release of *DTrack2* is always available at the *ART* Download Center (<http://www.ar-tracking.com/support/>).

⇒ **I want to run a software update. How do I preserve my data and my configurations?**

Your data and your configurations are automatically preserved when running a software update. But it is recommended to regularly create backups of your configuration(s). Please refer to chapter 7.4.2.1 on page 88 for further details.

⇒ **How do I run a software update?**

Please contact *ART* to receive the latest software release and follow the instructions in chapters 7.1.3 on page 69 and 7.8.1 on page 127.

⇒ **Do I have to update the *DTrack2* frontend software and the software of the controller at the same time?**

We recommend to do so.

⇒ **My specific settings have been lost.**

Please check if the correct configuration is selected: go to *DTrack2* → *Configurations* and select the correct configuration. Please refer to chapter 7.4.2 on page 87 for further details.

⇒ **Is it possible to automatically start the measurement after booting the controller?**

Yes, go to *Settings* → *Tracking* and tick the checkbox '*automatic start of measurement after booting*'. Please refer to chapter 7.5.5 on page 94 for further details.

⇒ **May I close the *DTrack2* frontend software window after starting the measurement?**

Yes, the measurement continues even if the *DTrack2* frontend software is not active.

⇒ **What's the version of my *DTrack2* software?**

Go to *About* → *DTrack2* to find out the version of your *DTrack2* frontend software and the backend software on the controller. Please refer to chapter 7.9 on page 128 for further details.

⇒ **There are greyish areas in my Monitor 2DOF display. What do they indicate?**

The static reflex suppression is currently active. This is indicated with these greyish areas. Markers in these areas will not contribute to tracking.

Please refer to chapter 7.6.1 on page 104 for more information.

⇒ **What do the abbreviations "SR", "DR" and "UD" mean?**

SR ... static reflex suppression active
UD ... display orientation is upside down

Please refer to chapter 7.3.3.1 on page 81 for more information on the additional *Monitor 2DOF display* settings.

⇒ **The display bar in the Monitor 2DOF display is indicating very high radiation intensities, although no markers are illustrated. Where's the radiation coming from?**

Furthermore, remove other strong IR radiation sources from the tracking volume or, at least, prevent them from interfering with the tracking system. Please refer to chapter 4.1.5 on page 30 for more information.

⇒ **Monitor 2DOF and/or Data Display are 'freezing' after some time, although tracking didn't stop.**

This can be caused by a firewall that is running on the *DTrack2* PC and blocking (UDP) output data.

Please check your firewall settings and ensure that it is not blocking *DTrack2* application, even partly.

8.7 Calibration

⇒ **How can I find out when the room has been calibrated last time?**

Please go to *Calibration* → *Room* and click *Show details*. The date of the last room calibration is shown.

⇒ **How do I define position and orientation of the room coordinate system?**

The calibration angle defines position and orientation of the room coordinate system depending on how you place it within the tracking volume. Please refer to table 7.16 on page 108.

DTrack2 offers the possibility to adjust the room coordinate system after the room calibration. Please refer to chapter 7.6.4 on page 110 for more information.

⇒ How do I have to move the wand?

Move the wand gently within the measurement volume, in order to generate a virtual point cloud. This point cloud should fill at least about two thirds of the measurement volume. Please refer to chapter 4.1.6 on page 31 for more information.

⇒ I do not succeed in performing a room calibration.

- Please make sure that the calibration angle is placed within the measurement volume such that it is seen completely by at least two cameras (→ verify with *Monitor 2DOF* display). If not all cameras see the angle be sure that a sufficient volume connects each camera to the others. No other marker except for the ones belonging to the calibration angle should be visible.
- Please make sure that the correct calibration set ('*Room Calibration Set TP*', '*Room Calibration Set 410*' or '*Room Calibration Set 710*') is selected in the settings for room calibration. Please refer to chapter 7.6.3 on page 105 for details.
- Please make sure that no reflections are seen by the cameras. If it is not possible to eliminate the reflections you may use static suppression of reflections to remove them. Please refer to chapter 4.1.5 on page 30 for more information.
- Please make sure that the markers positioned on the calibration angle are not damaged or misarranged.
- Increase the flash intensities of the cameras until all markers are of good quality (i.e. at least yellow). Please refer to chapter 7.5.1 on page 90.

Restart the room calibration. Move the wand gently within the measurement volume, in order to generate a virtual point cloud. This point cloud should fill at least about two thirds of the measurement volume.

Please refer to chapter 4.1.6 on page 31 for more information.

⇒ I cannot cover two thirds of the measurement volume within the set time for the room calibration. How do I extend the time for the calibration process?

Please open the dialogue *Calibration* → *Room* and click *Show details*. There you can extend the duration for the calibration process. Please refer to chapter 7.6.3 on page 105 for more information.

⇒ How shall I evaluate the room calibration results?

Please refer to chapter 7.6.3.2 on page 109 for a detailed explanation.

⇒ ***DTrack2* reports the error message "no angle tool detected". What went wrong?**

First of all, please double-check if all markers are visible and that there are no disturbing reflexes. Sometimes, it might help to move the calibration angle a little bit.

Please always verify the settings for the room calibration before repeating:

- wand length is printed on a label on the wand;
- select the correct calibration set.

⇒ **The progress bar of the room calibration stopped.**

Please double-check in the *Monitor 2DOF* display whether the calibration wand is recognized by the cameras during its movement.

⇒ **What is a "re-calibration" and when do I have to perform one?**

DTrack2 provides simplified room and body calibrations, called room and body re-calibration. The main advantage of a re-calibration is that *DTrack2* preserves the origin and the orientation of your coordinate system as well as specific information (predefined emission vectors, cylindrical marker).

You may perform a room re-calibration from time to time or if a camera moved slightly (e.g. due to mechanical instabilities). Please refer to chapter 7.6.3.3 on page 109.

If your body fell down or if the structure is bent you should carry out a body re-calibration. Please refer to chapter 7.6.5.7 on page 121 for more information.

⇒ **What does 'scaling factor' mean?**

Performing a room calibration results in a certain scaling error. This might be a problem when applications do have very high accuracy requirements (e.g. when performing measurements with the Measurement Tool).

The scaling error can be determined, for instance, by measuring points on a defined scale (e.g. tape measure). The determined scaling error can thus be adjusted with the *DTrack2* 'scaling factor' (refer to chapter B.1.1.1 on page 155).

Please contact **ART** if you require further information.

⇒ **I cannot calibrate my target.**

- Please check if the markers of the target are seen by the cameras in good quality (i.e. at least yellow) - a slight change of the target position might help. If necessary increase the flash intensities of the cameras. Therefore, go to *Settings* → *Cameras*.
- Make sure that when starting the body calibration every marker of the target is visible

to the cameras.

- A body calibration can be carried out only if a valid room calibration has been carried out before. Check in the *Event Display* if there is a warning saying 'no valid room calibration', additionally the button *Calibrate* is greyed out and cannot be clicked. In that case, please carry out a new room calibration.
- Please make sure using the *Monitor 2DOF* display that no marker is overlapped (i.e. merged) by another one. If necessary rearrange the target and restart the body calibration.
- Try to carry out the body calibration with a moving target. Therefore, shift the starting position of the target for calibration (often a shift of 10 or 20cm is enough to enable calibration again).
- Make sure that no other markers or targets are inside the tracking volume other than the one you want to calibrate.
- Please carry out a new room calibration.

⇒ **I'd like to save all my body files for backup reasons but I receive less files than configured bodies.**

DTrack2 only creates body files for calibrated bodies. For example: if you configured 15 targets for tracking but only 4 of them are calibrated, you will only receive 4 calibration files.

⇒ **I'd like to calibrate a body but the body calibration dialogue is greyed out.**

Please ensure that you have performed and accepted a valid room calibration prior to body calibration. Check in the *Event Display* if there is a warning saying 'no valid room calibration'.

You may only calibrate bodies if you have the 'Extended' or the 'Full-featured' license. With a 'Basic' license you are only able to calibrate bodies using a calibration file. Go to *DTrack2* → *Licenses* to see which license you have.

Starting with *DTrack2* version v2.10 a new license model has been established. Thus you are always allowed to manually calibrate up to 4 bodies at least.

⇒ **What is the difference between 'due to body' and 'due to room'?**

When selecting 'due to body', the body coordinate system is fixed by the markers of the rigid body. The origin of the body coordinate system is set to the center of gravity of all markers building the rigid body when 'due to room' is used.

Please refer to chapter 7.6.5.4 on page 117 for more information.

⇒ **Do I have to move the target while performing a body calibration?**

If possible we recommend to perform moderate movements because accuracy can be improved doing so. However, the body has to be visible to the cameras all the time.

⇒ **May I change the position and the orientation of the body coordinate system later on?**

Yes, you may use the dialogue *Body adjustment* to alter position and orientation of the body coordinate system. Please refer to chapter 7.6.6 on page 122 for more information.

⇒ **How do I define a name for a target?**

Go to *Settings* → *Body Administration (F8)*. Double-click into the name field and enter a name for the respective body. Please refer to chapter 7.5.6 on page 95 for more information.

⇒ **I cannot increase the number of targets anymore.**

The maximum number of targets to be tracked (including Flysticks and Fingertracking hand devices) depends on the license that is installed. With the 'Basic' and the 'Extended' license you may only use 4 targets at the same time - the 'Full-featured' license supports 50 targets. Go to *DTrack2* → *Licenses* to see which license you have.

Starting with *DTrack2* version v2.10 a new license model has been established. You may activate and calibrate 4, 10, 30 or up to 50 targets depending on the license purchased. Please refer to table 7.6 on page 86 for more information.

⇒ **How shall I evaluate the body calibration results?**

Verify that all markers of the target have been recognized during the *DTrack2* body calibration. Further, you may check if the single distances between the markers are correct (refer to chapter 7.6.5.3 on page 117).

As a special service you may send us the calibration file and we are going to check it.

8.8 Tracking

⇒ **My target (active or passive) is not recognized sporadically or only partly or even not at all.**

- Go to *Settings* → *Cameras* and tick the checkbox '*modulated flash*'.
- Also, take into account that the distance between active target and cameras should not exceed 2.5 m

- Active targets cannot be used near or in front of plasma screens. The IR emission of the plasma screen overdrives the IR receiver in the active target. See also the FAQ section: Operation near plasma screen.
- Please perform a new room calibration.
- Double-check if the marker surface is not dirty or dusty and that it doesn't appear to be worn out.

⇒ **Tracking does not work.**

- Please make sure that the measurement has been started and that the target is within tracking range of the cameras.
- If marker recognition is poor then increase the flash intensity.
- Check number of markers that are used for calculation. If all markers of the target are seen by the cameras, but partly not used for calculation, then execute a new room calibration.
- Go to *Settings* → *Output*. Define a receiver for the tracking data and configure the type of data to be transmitted.
- Activate the tracking functionality within your graphics application.

⇒ **I'm having too many heavy reflections.**

- Please double-check that the flash intensities of the cameras are not too high. In general, a flash intensity of 3-4 might be sufficient.
- Make sure that no other strong infrared radiation sources (e.g. sunrays or halogen lamps) are present in the tracking volume. If they cannot be removed you may use the reflex suppression feature of *DTrack2*.

⇒ **Does *DTrack2* send data if no target is being tracked?**

No tracking data is sent except for the frame number ('fr').

⇒ **The application PC does not receive tracking data.**

- Go to *Settings* → *Output*. Define a receiver for the tracking data and configure the type of data to be transmitted.
- Check the network connection physically and try to address the controller with a 'Ping'.
- Double-check with a UDP receiver if data is being sent by the controller.
- Activate the tracking functionality within your graphics application.

⇒ **May I use passive and active targets at the same time?**

Yes, of course, there are no restrictions on using passive and active targets simultaneously.

⇒ **I am moving my target upwards but within the Monitor 2DOF display it moves downwards.**

The camera is set to display data upside down. In the Monitor 2DOF display, right-click on the respective camera window and disable *Display upside down*.

8.9 Flystick

⇒ **My Flystick is not listed under the available Flysticks list.**

- Make sure that the battery is charged. Press any button of the Flystick and the orange status LED should be switched on.
- Go to *Settings* → *ART Radio Info* → *Show details* and set the channel number manually.

⇒ **Why is the pressing of the Flystick buttons not recognized (within *DTrack2*)?**

- Make sure that the battery is charged. Press any button of the Flystick and the orange status LED should be switched on.
- Double-check whether the button pressed events are recognized by *DTrack2*. Therefore:
 - enable the Flystick Display (*Display* → *Flystick*)
 - blue rectangles should light up on each button pressed event in the Flystick Display.
- Go to *Settings* → *ART Radio Info* → *Show details* and set the channel number manually.
- Go to *Settings* → *Flystick* and assign your Flystick (to be found in the available Flysticks list) to any '*Flystick ID*'.

⇒ **Why is the pressing of the Flystick buttons not recognized (within the graphics application)?**

- Make sure that the battery is charged. Press any button of the Flystick and the orange status LED should be switched on.
- Go to *Settings* → *Flystick* and assign your Flystick (to be found in the available Flysticks list) to any '*Flystick ID*'.

- Go to *Settings* → *Output* and check if the data output is configured correctly:
 - data receiver defined ('*send to*'),
 - identifier '*6df2*' selected,
 - if you are using the old output format: identifier '*6df*' selected.

⇒ **What is the maximum number of Flysticks to be used simultaneously?**

type	max. number
Flystick2	5
Flystick3	2

Please double-check that the targets of the Flysticks, that are used simultaneously, are not identical. If doubts remain please contact **ART**.

⇒ **What is the MultiUser option for Flysticks?**

The MultiUser option is an enhancement especially for VR/AR applications when working with more than one Flystick.

Please refer to chapter 5.3.2 on page 46 for more information.

⇒ **The Flystick output data is not transmitted.**

Go to *Settings* → *Output* and check if the data output is configured correctly:

- data receiver defined ('*send to*'),
- identifier '*6df2*' selected,
- if you are using the old output format: identifier '*6df*' selected.

8.10 Measurement Tool

⇒ **I'm using the Measurement Tool demo but I cannot measure any points.**

Please check whether both, the Measurement Tool and the Measurement Tool reference body (if assigned), are tracked.

⇒ **It is not possible to perform a tip calibration.**

Please check whether both, the Measurement Tool and the Measurement Tool reference body (if assigned), are tracked.

Then, try to keep the tip in the same position while doing the tip calibration. Therefore, tilt the Measurement Tool in both room directions, not only in one direction (i.e. left and right, as well as back and forth). When rotating around one axis only, a tip position cannot be defined.

8.11 Active Targets

⇒ Operation near plasma screen

A plasma screen is a very strong IR source which overdrives the IR receiver in the active target (e.g. active Flystick3 (discontinued), Fingertracking). Thus, active targets may not work properly near plasma screens. If possible use passive targets as alternative.

8.12 *ART* tracking and 3D TVs

⇒ Synchronization

3D TVs are primarily consumer products which have not been designed to fulfill the requirements of professional users. In fact, this especially applies when it comes to synchronizing the 3D TV and the tracking system. Typically, there's no defined synchronization output which could be used easily. In some rare cases, *ART* might be able to assist.

⇒ Shutter glasses

IR synchronized shutter glasses might not work with *ART* tracking systems. Due to the increasing variety, *ART* only validated a few of these shutter glasses. However, we may support customers who are performing tests with not validated shutter glasses. Please contact us to receive information on this issue.

8.13 Radio transceivers used in *ART* products

⇒ Can *ART* radio transceivers pose any security issue ?

Radio transceivers for Flysticks, Measurement Tool or Tactile Feedback use a protocol based on IEEE 802.15.4 which was developed in-house at *ART* specifically for these devices. The protocol is proprietary, no other devices should work with this protocol. The design of the ATC ensures that use of this protocol is limited to transferring measurement data (like button-pressed events) and configuring devices.

9 General Information

9.1 Service

It is recommended to maintain the equipment every three years. If you experience any problems please do not hesitate to contact our support.



Never try to repair anything yourself!!

Opening the equipment implies risks for health and environment as well as loss of warranty and liability.

9.2 Cleaning of the equipment

Only the housing of the cameras may be cleaned. Before cleaning shut down the system and disconnect the power cords.

Never use water or any chemicals. Just use a dry, lint-free and antistatic tissue like lens-cleaners for optical equipment.



Do not open the housings!

Opening the housings implies risk for health and environment, as well as loss of warranty and liability.

9.3 Warranty and liability

Hardware *ART* warrants the hardware to be free from defects in workmanship and material under normal use and service and in its original, unmodified condition, for a period of 24 months from the time of purchase. The time of purchase is defined as the day when the end-user takes possession of the equipment. If *ART* or any company authorized by *ART* installs the system, the time of purchase is the time of the first installation.

In case of defects during the warranty period, *ART* will repair or replace any defective parts. Replaced parts become property of *ART*.

9 General Information

Software Software supplied either on the tracking-PC or in cameras is furnished on a tested "As Is" basis. **ART** explicitly does not warrant that the software is error (bug) free. If the users detect bugs, **ART** will provide a workaround or bug fix as soon as possible after the notification.

Liability **ART** products are not authorized for use in any circumstances where human life might be endangered by malfunction, measurement errors or interrupted operation of the system without written approval of a managing director of **ART**.

It is the user's sole responsibility to check the results of the measurement data and to protect any consecutive system against malfunction, measurement errors or interrupted operation of the systems supplied by **ART**. Under no circumstances **ART** can be held liable for consequential damages or incidental costs, including production downtimes, whether arising from measurement errors, interrupted operation or any other malfunction of the system.

Warranty restrictions All warranty and liability is void, if the system

- is not operated according to the manual,
- shows damages or signs of abuse,
- has been opened by non-authorized people (non-members of **ART** and companies not authorized by **ART**),
- has been modified by the user or any third party,
- has not been used according to the specifications of this manual.

9.4 Declaration of conformity



EUROPEAN DECLARATION OF CONFORMITY STATEMENT

Advanced Realtime Tracking GmbH

declares under its sole responsibility that the product

SMARTTRACK

to which this declaration relates is in conformity to the following standard(s) or other normative document(s)

- | | |
|--|--|
| 2014/35/EC (Low Voltage Directive): | EN 60950-1:2006 +
A11:2009 + A1:2010 +
A12:2011 + A2:2013 |
| 2014/30/EC (EMC Directive): | EN 55032:2015 +
AC:2016
EN 55024:2010 +
A1:2015
EN 61000-3-2:2014
EN 61000-3-3:2013 |
| 2011/65/EC (RoHS Directive): | EN 50581:2012 |

Weilheim i. OB, 16.01.2018

A handwritten signature in blue ink, appearing to read 'A. Weiss', is written over a horizontal line. Below the line, the text 'Dr. A. Weiss (Managing Director)' is printed.

Advanced Realtime Tracking GmbH Am Öferl 6 82362 Weilheim i. OB Germany



**MANUFACTURER'S FEDERAL COMMUNICATION COMMISSION
DECLARATION OF CONFORMITY STATEMENT**

Advanced Realtime Tracking GmbH

declares under its sole responsibility that the product

SMARTTRACK

to which this declaration relates is in conformity to the following standard:

**FCC 47 CFR Part 15, Subpart B
Class B digital device**

Operation is subject to the following two conditions:

- (1) this device may not cause harmful interference, and
- (2) this device must accept any interference received, including interference that may cause undesired operation.

Weilheim i. OB, 08.09.2014



Dr. A. Weiss (Managing Director)

Advanced Realtime Tracking GmbH Am Öferl 6 82362 Weilheim i. OB Germany



ZERTIFIKAT ◆ CERTIFICATE ◆ 認証証書 ◆ CERTIFICADO ◆ CERTIFICAT



Product Service

CERTIFICATE

No. Z1A 14 04 52228 007

Holder of Certificate: **Advanced Realtime Tracking GmbH**
 Am Öferl 6
 82362 Weilheim
 GERMANY

Factory(ies): 52228

Certification Mark:



Product: **Scanner
 (IR-Tracking Camera)**

Model(s): **SMARTTRACK**

Parameters:

Rated voltage:	SMARTTRACK
Rated power:	5 VDC
Protection class:	max. 20 W
	III

Tested according to: EN 60950-1/A2:2013
 ZEK 01.4-08

The product meets the safety and health requirements of the German Product Safety Act section 20 to 22 ProdSG. The certification marks shown above can be affixed on the product. It is not permitted to alter the certification marks in any way. In addition the certificate holder must not transfer the certificate to third parties. This certificate is valid until the listed date, unless it is cancelled earlier. See also notes overleaf.

Test report no.: 028-713035476-000

Valid until: 2019-04-08

Date, 2014-04-11

 (Ralph Fischer)

Page 1 of 1



ZERTIFIKAT • CERTIFICATE • 認証証書 • CERTIFICADO • CERTIFICAT

UCB / 10.10



America

CERTIFICATE

No. U8 17 02 52228 014

Holder of Certificate: Advanced Realtime Tracking GmbH

Am Öferl 6
82362 Weilheim
GERMANY

Production Facility(ies): 52228

Certification Mark:



C US

Product: Scanner
(IR-Tracking Camera)

Model(s): SMARTTRACK

Parameters: SMARTTRACK

Rated voltage:	5 VDC
Rated power:	max. 20 W
Protection class:	III

Tested according to: UL 60950-1:2007/R:2014-10
CAN/CSA-C22.2 No. 60950-1:2007/A2:2014-10

The product was voluntarily tested according to the relevant safety requirements noted above. It can be marked with the certification mark above. The mark must not be altered in any way. This product certification system operated by TÜV SÜD America Inc. most closely resembles system 3 as defined in ISO/IEC 17067. Certification is based on the TÜV SÜD "Testing and Certification Regulations". TÜV SÜD America Inc. is an OSHA recognized NRTL and a Standards Council of Canada accredited certification body.

Test report no.: 028-713035476-100

Date, 2017-02-16

Page 1 of 1



TÜV SÜD AMERICA INC. • 10 Centennial Drive • Peabody MA 01960 USA • www.TUVamerica.com

TUV®

A Technical specifications



The specifications are subject to change without notice.

A.1 SMARTTRACK

Power supply

Nominal voltage	5V DC
Maximal current	4A
Maximal power	20W
Ext. power supply	5V / 4A / 20W

Protection category

Ext. power supply	I
Camera	III

Interface connectors

data	RJ45
synchronization	BNC
power	external
Flystick2 and 3	internal Radio Transceiver, no external USB Radio Transceiver is allowed

Operating conditions

Temperature	0 .. 35°C
Relative humidity	5 .. 50%
	non-condensing
Cooling system	active (fan)

Dimensions

Length	approx. 420mm
Width	approx. 105mm
Height	approx. 55mm
Weight	approx. 1300g

Performance

Frame rate	max. 60fps (adjustable)
IR flash	850nm
Max. tracking distance with 12mm passive markers (F .. focal length in mm).	
@ F = 2.1mm	2.5m
Maximum number of 6DOF targets (simultaneously)	
@ 60fps	> 4
Field of view (FoV for each lens, horizontal × vertical)	

A.2 Flysticks

	Flystick2	Flystick3
Power supply		
Rechargeable battery ¹	3 Micro-AAA batteries	lithium battery (850mAh / 3.7V) integrated in the handheld
Continuous operation ²	at least 10 hours	at least 8 hours
Battery charging duration		
Operation possible with connected charger	no	yes
USB transmitter		
Connection to the PC	USB	USB
Radio range (depending on setup location, e.g. walls)	at least 7m	at least 7m
Radio module		
Type ID	IEEE 802.15.4	IEEE 802.15.4
Frequency	2.4 GHz	2.4 GHz
Transmission power	1	1
Operating conditions		
Operating temperature	0 .. 40°C	0 .. 38°C
Relative humidity	5 .. 50%, non-condensing	5 .. 50%, non-condensing
General features		
Target type	passive markers	passive or active markers (IR-LEDs @ 880nm)
Tracking range (@ 3.5mm focal length)	approx. 4m	approx. 4.5m
Weight	250g	120g
Size	220mm x 180mm x 100mm	245m x 90mm x 75mm

¹ replacement after a period of 2 years is recommended

² valid for new batteries

A.3 Overall system

Compatible shutter glasses

NuVision APG6000	×
NuVision APG6100	×
NVidia 3D Vision Pro	×, radio synchronization
RealD CE1	×
RealD CE2	×
RealD CE3	×
RealD CE4	-
RealD CE5	×
Volfoni EDGE	×, with Volfoni or NuVision Long-Range Emitter
XPand X103	×, with NuVision Long-Range Emitter
XPand X101	×
XPand X104LX	×
Virtualis ActiveWorks 500	×

DTrack2 frontend software

System requirements	
- Free disk space	≥ 200MB
- Processor	Intel: ≥ P4 2GHz AMD: ≥ K6 1.6Ghz
- RAM	≥ 1GB
Operating systems	Windows 7 32/64 Bit Windows 8/8.1 32/64 Bit Windows 10 32/64 Bit Linux openSUSE ≥ 12.3 32/64 Bit Linux Ubuntu ≥ 10.04 32/64 Bit Linux CentOS ≥ 6.6 32/64 Bit
Settings firewall (remote PC)	
- used ports	50105 (for UDP & TCP) 50110 (for UDP)

A.4 System latency

System Latency

Definition of the system latency:

The system latency is defined as the time delay between sending out the IR flash by the cameras and the availability of the tracking data at the Controller's Ethernet output. The latency is a function of the number of cameras, the number of targets, enabled or disabled 3DOF tracking and additional reflexes (e.g. single markers). Another dependency, which is quite important, can be found in the software version of **DTrack2** being used (here: v2.8.6). We recommend to always use the latest version in order to have the most recent features.

For **SMARTTRACK** : The **SMARTTRACK** is triggered externally with an arbitrary function generator at 60 Hz. The network package with the tracking results can be triggered with an oscilloscope.

SMARTTRACK

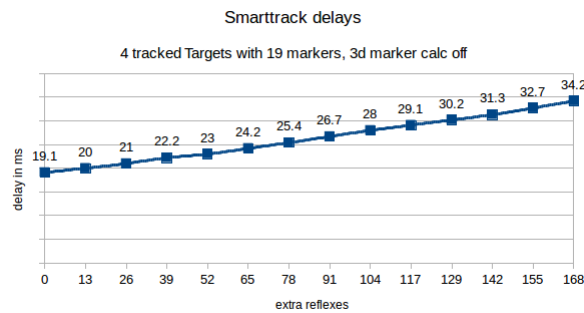

B Technical Appendix

B.1 Definition of Coordinates and Rotations

B.1.1 Room Calibration

The calibration angle defines origin and axes of the coordinate system. This can be done in two different ways:

Type	longer arm	shorter arm
'normal'	+X axis	+Y axis
'powerwall'	+X axis	-Z axis

For example, a room calibration of type '*normal*' would result in a coordinate system like the following:

1. The marker located in the crossing point of the two arms is defining the origin of the coordinate system.
2. The longer arm of the calibration tool defines the +X axis.
3. The shorter arm of the calibration tool defines the +Y axis. (i.e., the tool markers define the X/Y plane.)
4. The Z axis is added in order to give a right-handed coordinate system.

B.1.1.1 Room Adjustment

DTrack2 allows to modify the room coordinate system by specifying these seven values:

- l_x, l_y, l_z for a translational offset (denoted x, y, z in the GUI),
- η, θ, ϕ for a rotation (denoted rx, ry, rz in the GUI).
- s for a scaling factor.

These offsets are defined as a shift and/or rotation and/or scaling of the room coordinate system relative to the original one. Mathematically a point \vec{x}_{orig} in the original room is transformed into a point \vec{x}_{mod} in the modified room coordinate system by:

$$\vec{x}_{mod} = (R^T \cdot \vec{x}_{orig} - \vec{l}) \cdot s$$

where the rotation matrix R is calculated from η, θ and ϕ like defined in section B.1.3.

B.1.2 Body Calibration

During the body calibration *DTrack2* is fixing a local coordinate system (body coordinate system) for each rigid body. Both coordinate systems define the later 6DOF output (see chapter B.1.3 on page 157). The calibration can be done in three different ways (to be selected in the menu *Calibrate / Body* of the body calibration):

B.1.2.1 Definition of the Coordinates by the Body itself

Body calibration setting *due to body*:

The body coordinate system is fixed by the markers of the rigid body according to a set of rules:

1. Search the biggest distance between two markers of the rigid body. These two markers (#1 and #2) will define the X axis.
2. Search for a third marker (#3) that has the smallest distance to one of the two markers #1 and #2. The marker that has smallest distance to marker #3 becomes marker #1. It will define the coordinate origin. The other marker will be #2. The positive X axis is directed from marker #1 to marker #2.
3. Marker #3 defines the X/Y plane, together with markers #1 and #2. Marker #3 has a positive Y coordinate.
4. The Z axis is already defined by these rules, resulting in a right-handed coordinate system.

B.1.2.2 Definition of the Coordinates by the Room Coordinate System, with Origin in the Center of the Markers

Body calibration setting *due to room*:

The origin of the body coordinate system is set to the center (center of gravity) of all markers building the rigid body. The axes of the body coordinate system are parallel to the axes of the room coordinate system in the beginning of the body calibration.

I.e., the result of a body calibration will depend on the angular position of the target during calibration. A 6DOF measurement, following calibration without having moved the body, will give the angular coordinates $0^\circ / 0^\circ / 0^\circ$.

If the target was moved during calibration, the angular position of the target at the beginning of the calibration will be taken.

B.1.2.3 Definition of the Coordinates by the Room Coordinate System, with Origin in a Marker

Body calibration setting *due to room (zero in marker)*:

A combination of the first two methods. The direction of the axes of the body coordinate system will be set parallel to the room coordinate system in the moment of body calibration

- like done with setting *due to room*. The origin of the body coordinate system is given by one marker of the body, according to the rules given for setting *due to body*.

B.1.2.4 Coordinate System Definition for 5DOF Targets (with and without cylinder markers)

Body calibration setting *x/y/z*:

In the body coordinate system all markers of the target are on the selected axis. The origin is in the middle between the two markers with the largest distance to each other. The orientation is defined by the marker with the smallest distance to the origin. Its position has a negative sign. The other two directions are undetermined due to the one degree of freedom.

B.1.2.5 Coordinate System Definition for two 5DOF Targets with cylinder markers

Body calibration setting *xy/yx/yz/zy/zx/xz*:

The body is expected to consist of two about perpendicularly connected 5DOF targets. These are placed on the two axes. The origin is placed at the position where the two 5DOF targets intersect. The first axis is assigned to the 5DOF target which includes the marker with the largest distance to the origin. The other 5DOF target is placed in the plane created by the two axes.

B.1.3 6DOF Results

Position and Orientation

Position and orientation of a target are expressed by an affine transformation (\vec{s} , R) that transforms a vector \vec{x} from the body coordinate system to the room coordinate system:

$$\vec{x}_{room} = R \cdot \vec{x}_{body} + \vec{s}$$

I.e., the coordinates \vec{s} give the position of the origin of the body coordinate system (marker #1 or center of gravity, as described above), measured in room coordinates.

The 3×3 rotation matrix R describes the rotation part of the transformation. The columns of the matrix R are the axes (X, Y, Z) of the body coordinate system, expressed in room coordinates.

Description by Rotation Angles

The rotation matrix can be replaced by three consecutive rotations $R_i(\chi)$ (rotation angle χ , rotation axis i). The angles, as given in the *DTrack2* data output, are defined by the equation:

$$R = R_x(\eta) \cdot R_y(\theta) \cdot R_z(\phi)$$

Expressed in trigonometric functions, that means:

$$R = \begin{pmatrix} \cos \phi \cos \theta & -\sin \phi \cos \theta & \sin \theta \\ \sin \phi \cos \eta + \cos \phi \sin \theta \sin \eta & \cos \phi \cos \eta - \sin \phi \sin \theta \sin \eta & -\cos \theta \sin \eta \\ \sin \phi \sin \eta - \cos \phi \sin \theta \cos \eta & \cos \phi \sin \eta + \sin \phi \sin \theta \cos \eta & \cos \theta \cos \eta \end{pmatrix}$$

Note that per definitionem the angles can only have the values:

$$-180^\circ \leq \phi \leq 180^\circ, -90^\circ \leq \theta \leq 90^\circ, -180^\circ \leq \eta \leq 180^\circ$$



Note: rotation angles can show strange behaviour at certain orientations. In particular, for orientations close to $\theta = \pm 90^\circ$ the other two angles can experience large odd-looking changes (so called “Gimbal Lock”).

When connecting *DTrack2* to an application, often problems appear caused by different definitions of rotation angles. To avoid that, we recommend to use rotation matrices.

B.1.4 3DOF Data

Besides the tracking of 6DOF bodies, *DTrack2* is able to calculate the coordinates of single markers, i.e. markers that can not be recognized as part of a rigid body. The output values are the coordinates of these markers, measured in room coordinates. In some situations, a rigid body within the measurement volume is (temporarily) not correctly recognized by the software. In these cases, its markers appear as 3DOF objects. 3DOF markers are tracked (as long as possible) and labeled with an ID number. When a 3DOF marker vanishes (or is recognized as part of a 6DOF body), its ID number will not be used any more, as long as the tracking is active.

B.1.5 Flystick devices

DTrack2 is supporting the following input devices:

- Flystick2 and
- Flystick3.

Each of the afore mentioned devices is equipped with buttons (4 - 8) and a small joystick. Input transactions are transmitted wirelessly to the controller and added to the 6DOF tracking result of the Flystick body.

There are two types of output formats available, called 6df and 6df2 (details see chapter B.2.5 on page 164 and chapter B.2.6 on page 165); they differ in the number of carried input controls. Only the newer 6df2 format is capable of processing analogue values (or controllers) as produced by a joystick. Both formats use the same order of buttons (details see below):

Output Format	Number of Buttons	Order of Buttons	Number of Controllers
6df	8 (fix)	“right to left”	—
6df2	device dependent	“right to left”	device dependent

B.1.5.1 Flystick2

Each Flystick2 is equipped with six switches (buttons) and a small joystick, that produces two analogue values, one for horizontal and one for vertical movement. When using the old output format 6df, the joystick values are transferred into hat switch actions; two of the buttons cannot be accessed.

Switch	labelled as (in figure B.1)	6df Output	6df2 Output
front switch (yellow)	id 0	code 01 (hex)	button code 01 (hex)
outer right switch on backside (blue)	id 1	code 02 (hex)	button code 02 (hex)
inner right switch on backside (blue)	id 2	code 04 (hex)	button code 04 (hex)
inner left switch on backside (blue)	id 3	code 08 (hex)	button code 08 (hex)
outer left switch on backside (blue)	id 4	—	button code 10 (hex)
switch on joystick (yellow)	id 5	—	button code 20 (hex)
joystick (yellow) to the left	—	code 20 (hex)	first controller up to 1.0
joystick (yellow) to the right	—	code 80 (hex)	first controller up to -1.0
joystick (yellow) up	—	code 40 (hex)	second controller up to 1.0
joystick (yellow) down	—	code 10 (hex)	second controller up to -1.0

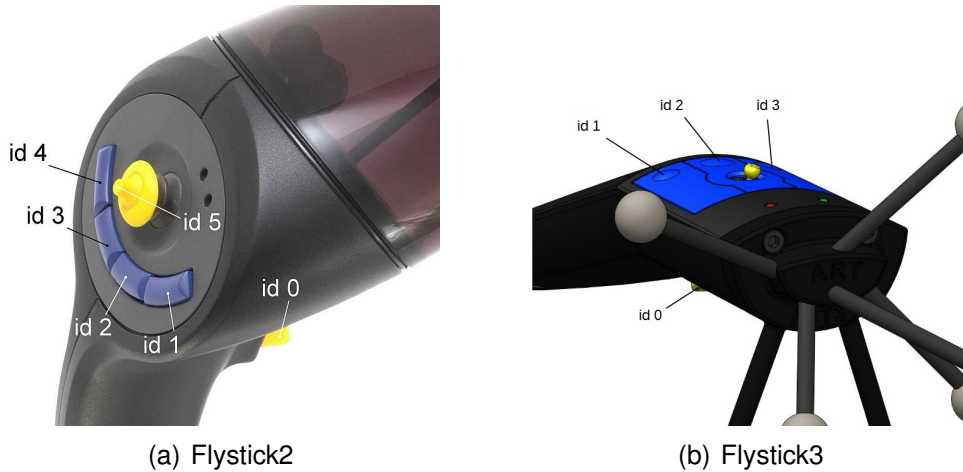

Figure B.1: Allocation of ID number to the Flystick buttons

B.1.5.2 Flystick3

Each Flystick3 is equipped with four switches (buttons) and a small joystick, that produces two analogue values, one for horizontal and one for vertical movement. When using the old output format 6df, the joystick values are transferred into hat switch actions.

Switch	labelled as (in figure B.1)	6df Output	6df2 Output
bottom switch (yellow)	id 0	code 01 (hex)	button code 01 (hex)
top right switch (blue)	id 1	code 02 (hex)	button code 02 (hex)
top middle switch (blue)	id 2	code 04 (hex)	button code 04 (hex)
top left switch (blue)	id 3	code 08 (hex)	button code 08 (hex)
joystick (yellow) to the left	–	code 20 (hex)	first controller up to 1.0
joystick (yellow) to the right	–	code 80 (hex)	first controller up to –1.0
joystick (yellow) up	–	code 40 (hex)	second controller up to 1.0
joystick (yellow) down	–	code 10 (hex)	second controller up to –1.0

B.1.6 Measurement Tools



Only available, if the Measurement Tool license is present for DTrack2 (available since version v2.2.0)

The Measurement Tool license allows the use of Measurement Tools , i.e. pointing devices with a special target geometry. While tracking, the module calculates position and orientation of the tip of the tool. It is necessary to perform an additional calibration procedure (called tip calibration) to provide the module with information about the tip.

B.1.6.1 Orientation of a Measurement Tool

The module modifies the local coordinate system (i.e. the body coordinate system) of the tool's body as follows:

1. The tip becomes the origin of the coordinate system.
2. The marker with the largest distance to the tip defines the +Z axis.
3. The marker, that is closest to the tip, defines the Y/Z plane.

This definition shall ease the use of the tip orientation. For instance, the orientation of all **ART** Measurement Tools is approximately along the -Z axis.

B.1.6.2 Using a reference body

When using a reference body for a Measurement Tool , the module calculates the position of the tip \vec{x}_{ref}^S within the local coordinate system of the reference body:

$$\vec{x}_{room}^S = R_{ref} \cdot \vec{x}_{ref}^S + \vec{s}_{ref}$$

where \vec{x}_{room}^S is the position of the tip in room coordinates, and (\vec{s}_{ref}, R_{ref}) position and orientation (see B.1.3) of the reference body. The orientation of the Measurement Tool is transformed in an analogous way.

B.1.6.3 Covariance of Measurement Tool tip

DTrack2 provides an estimation for the current uncertainty of the measured position of the tool tip, expressed as a 3×3 covariance matrix Σ . Assuming a translational vector \vec{e}^S representing the error of the measured tip position, the covariances are calculated as the 'expected values' ($E()$) of:

$$\begin{aligned}\vec{x}_{meas}^S &= \vec{x}^S + \vec{e}^S \\ \sigma_{ij} &= E(e_i^S \cdot e_j^S)\end{aligned}$$

Intuitively, the diagonal entries of Σ_{tip} can be interpreted as the positional uncertainty in world coordinates. Off-diagonal values describe the statistical dependency between two values.

B.2 Output of Measurement Data via Ethernet

DTrack2 uses ethernet (UDP/IP datagrams) to send measurement data to other applications. The IP address and the port of the application (and the computer it runs on) can be configured in *Settings* → *Output*.

Each datagram carries all the results of a single measurement, coded in ASCII format. One datagram is sent after each measurement of the cameras, i.e. following the synchronization frequency. The 'send data divisor' in *Settings* → *Output* offers the possibility to decrease the data output frequency ($f_{output} = f_{sync}/d_{divisor}$).



All data are given in units millimeter (mm) or angular degree (deg / °).

ART provides free sample source code ('DTrackSDK', in C++) to receive and parse the output data. Please contact *ART* to get it.

A UDP datagram in ASCII format contains several lines separated by CR/LF (hex 0D 0A). Each line carries data of a specific type and starts with an identifier. In *Settings* → *Output* you may configure which lines or data types should be included in the output:

Identifier	Type of data	enable/disable in
fr	frame counter	always enabled
ts	timestamp	<i>Settings</i> → <i>Output</i> ('ts')
6dca1	additional informations	<i>Settings</i> → <i>Output</i> ('6dca1')
6d/6di	standard bodies (6DOF)	<i>Settings</i> → <i>Output</i> ('6d / 6di')
3d	additional markers (3DOF)	<i>Settings</i> → <i>Output</i> ('3d')
6df/6df2	Flysticks (6DOF + buttons)	<i>Settings</i> → <i>Output</i> ('6df / 6df2')
6dmt	Measurement Tools (6DOF + tip trafo)	<i>Settings</i> → <i>Output</i> ('6dmt')
6dmtr	Measurement Tool references (6DOF)	<i>Settings</i> → <i>Output</i> ('6dmtr')
6dmt2	Measurement Tool with sphere tip (6DOF + tip trafo + sphere radius)	<i>Settings</i> → <i>Output</i> ('6dmt2')

B.2.1 Frame Counter

Identifier `fr`.

This line is always the first one. It carries a frame counter (counting with synchronization frequency).

Example:

```
fr 21753
```

B.2.2 Timestamp

Identifier `ts`.

A timestamp can be added to each datagram. It shows the time at the measurement of this frame, i.e. the time when the infrared flash of the cameras is fired. The timestamp uses the internal clock of the controller, giving back the seconds (with an accuracy of $1\mu s$) since 00:00 UTC¹ (midnight). This implies that the timestamp value is reset to zero when passing midnight (UTC)!



The timestamp typically shows an accuracy of better than $\Delta t_{err} \sim \pm 0.01ms$ with a Synccard2 (used in ARTTRACK systems). With a SynccardTP (used in TRACKPACK systems) one can only expect an accuracy of $\Delta t_{err} \sim \pm 0.5ms$.

Example:

```
ts 39596.024831
```

B.2.3 Standard 6DOF Bodies

Identifier `6d`.

Measurement data of all tracked standard 6DOF bodies (i.e. all 6DOF bodies except Flysticks, Measurement Tools ...). Bodies, that are not tracked by the system at that moment, don't appear in the output.

- The first number gives the number of tracked bodies (less or equal to the number of calibrated bodies).
- The data of each tracked body show up in blocks (three consecutive []) like:

```
[id qu] [sx sy sz η θ φ] [b0 b1 b2 b3 b4 b5 b6 b7 b8]
```

They contain:

1. ID number (`id`, starting with 0), quality value (`qu`, unused),

¹Coordinated Universal Time = Greenwich Mean Time

2. Position (s_i), orientation angles ($\eta \theta \phi$) and
3. Rotation matrix (b_i) of the Body's orientation.

All numbers are separated by spaces (hex 20). Nine values $b_0 \dots b_8$ form the rotation matrix R :

$$R = \begin{pmatrix} b_0 & b_3 & b_6 \\ b_1 & b_4 & b_7 \\ b_2 & b_5 & b_8 \end{pmatrix}$$



Note: to avoid problems with different definitions of the angles, we recommend to use only rotation matrices.

Example (one line):

```
6d 1 [0 1.000] [326.848 -187.216 109.503 -160.4704 -3.6963
-7.0913] [-0.940508 -0.339238 -0.019025 0.333599 -0.932599 0.137735
-0.064467 0.123194 0.990286]
```

B.2.4 Standard 6DOF Bodies (extended format)

Identifier 6di.

Measurement data of all tracked standard 6DOF bodies (i.e. all 6DOF bodies except Flysticks, Measurement Tools ...) and all hybrid bodies. The output data contain values especially for hybrid bodies (tracking status, drift error), but can be used for any standard 6DOF body. Bodies, that are not tracked by the system at that moment, do appear in the output.

- The first number gives the number of tracked bodies.
- The data of each tracked body show up in blocks (three consecutive []) like:

$$[\text{id st er}] [s_x s_y s_z] [b_0 b_1 b_2 b_3 b_4 b_5 b_6 b_7 b_8]$$

They contain:

1. ID number (id , starting with 0), status of the tracking (st , 0: not tracked, 1: inertial tracking, 2: optical tracking, 3: inertial and optical tracking), current drift error estimation (er , unit: [deg], estimate rising by 10 degree per minute when tracking inertially)
2. Position (s_i) and
3. Rotation matrix (b_i) of the Body's orientation.

All numbers are separated by spaces (hex 20). Nine values $b_0 \dots b_8$ form the rotation

matrix R :

$$R = \begin{pmatrix} b_0 & b_3 & b_6 \\ b_1 & b_4 & b_7 \\ b_2 & b_5 & b_8 \end{pmatrix}$$

To avoid problems with different definitions of the angles, we recommend to only use rotation matrices.

Example (one line):

```
6di 2 [0 1 2.135] [326.848 -187.216 109.503] [-0.940508 -0.339238
-0.019025 0.333599 -0.932599 0.137735 -0.064467 0.123194 0.990286] [1 0
0.000] [0.000 0.000 0.000] [0.000000 0.000000 0.000000 0.000000 0.000000
0.000000 0.000000 0.000000 0.000000]
```

B.2.5 Flysticks

Identifier 6df2.



Note: this format version replaces the older 6df format (see B.2.6). Use it whenever possible.

The newer format for Flysticks is quite similar to the format of standard 6DOF bodies. It provides tracking data for all Flysticks and other **ART** radio devices (see B.1.5):

- The first number after the identifier 6df2 gives the number of defined (i.e. calibrated) Flysticks.
- The second number gives the number of Flystick data, that are following in the line.
- The data of each Flystick show up in blocks (four consecutive []), like:

```
[id qu nbt nct] [sx sy sz] [b0 b1 b2 b3 b4 b5 b6 b7 b8] [bt0 ... ct0 ct1 ...]
```

The four blocks contain:

1. ID number (id , starting with 0), quality value (qu , see below) and the number of available buttons and controllers (nbt and nct).
 2. Position of the Flystick (s_i).
 3. Orientation of the Flystick, given as rotation matrix (b_i , like standard bodies).
 4. Status of buttons (bt_i , see below) and controllers (ct_i , see below).
- The quality (qu) can (so far) just get the values 1.000 or -1.000. -1.000 means that the target of the Flystick is not visible at the moment. Even in that case a Flystick appears in the output data. Then dummy values are used for position (zero) and orientation (zero matrix!). Informations about buttons and controllers are valid as long as the wireless transmission is active.

- When buttons of the Flysticks are pressed the (decimal) numbers bt_i change. They are coded binary (i.e. switch 1 activated = bit 0 set, switch 2 activated = bit 1 set, ...) with a maximum of 32 buttons per bt_i number.

 **Note that the number of bt_i numbers in the block can vary with different Flystick hardware! If the device isn't equipped with buttons, the output won't contain any bt_i number!**

- Controller elements are transferred into floating point numbers ct_i , reaching from -1.00 to 1.00 . In the output line they follow the button informations (one number for each controller).

 **Note that the number of ct_i numbers in the block can vary with different Flystick hardware! If the device isn't equipped with controller elements, the output won't contain any ct_i number!**

Example (one line) for two devices, one Flystick2 (ID 0) and one Flystick1 (ID 1):

```
6df2 2 2 [0 1.000 6 2] [-228.992 270.818 92.561] [0.758006 -0.652230 0.004807 -0.651759
-0.757133 0.044271 -0.025236 -0.036691 -0.999008] [5 0.13 -1.00] [1 -1.000 4 2] [0.000
0.000 0.000] [0.000000 0.000000 0.000000 0.000000 0.000000 0.000000 0.000000 0.000000
0.000000] [1 1.00 0.00]
```

B.2.6 Flysticks (Old Format)

Identifier 6df.

 **Note: supported just for compatibility. It is recommended to use the newer Flystick format 6df2 (see chapter B.2.5 on page 164) whenever possible.**

 **Refer to chapter B.1.5.1 on page 159 to find out which buttons of the Flystick2 are NOT transmitted when using the old output format 6df.**

This older format for Flysticks is quite similar to the format of standard 6DOF bodies:

- The first number gives the number of defined Flysticks.
- The data of each Flystick show up in blocks (three consecutive []) like:

$$[id \text{ qu } bt] [s_x \ s_y \ s_z \ \eta \ \theta \ \phi] [b_0 \ b_1 \ b_2 \ b_3 \ b_4 \ b_5 \ b_6 \ b_7 \ b_8]$$

They contain:

1. ID number (id , starting with 0), quality value (qu , see below) and button information (bt , see below),
2. Position (s_i) and orientation angles ($\eta \ \theta \ \phi$) and
3. Orientation (b_i) of the Flystick.

- The quality (q_u) can (so far) just get the values 1.000 or -1.000 . -1.000 means that the target of the Flystick is not visible at the moment. Even in that case a Flystick appears in the output data. Then dummy values are used for position (zero) and orientation (zero matrix!). Informations about buttons are valid as long as the wireless transmission is active.
- When buttons of the Flysticks are pressed the (decimal) number bt changes. It is coded binary (i.e. switch 1 activated = bit 0 set, switch 2 activated = bit 1 set, ...).

Example (one line):

```
6df 1 [0 1.000 2] [261.103 116.520 41.085 19.6522 -57.3530 116.5992]
[-0.241543 0.968868 -0.054332 -0.482366 -0.168461 -0.859619
-0.842010 -0.181427 0.508039]
```

B.2.7 Measurement Tools with sphere tip

Identifier 6dmt2.



Note: this format version replaces the older 6dmt format (see B.2.9). Use it whenever possible.



Only available, if the Measurement Tool license is present for DTrack2 (available since version v2.9.1).

The output for Measurement Tool *with sphere tip* is defined as follows:

- The first number gives the number of calibrated Measurement Tools .
- The second number gives the number the following target data.
- The data of each tool show up in blocks (five consecutive []), like:

```
[id qu nbt rd] [sx sy sz] [b0 b1 b2 b3 b4 b5 b6 b7 b8] [bt] [σ11 σ12 σ13 σ22 σ23 σ33]
```

They contain:

1. ID number (id , starting with 0), quality value (q_u , see below) number of buttons (nbt) and the radius of the Measurement Tool tip sphere (rd).
 2. Measured position (s_i) of the tip
 3. Rotation matrix (b_i) of the tip orientation.
 4. Button (bt), binary coded (0x01 measurement of a point is active; 0x02, 0x04, ... designate buttons of the Measurement Tool)
 5. Covariance matrix (σ_{ij}) of the position of the tool tip (in mm^2)
- The quality (q_u) can (so far) just get the values 1.0 and -1.0 . -1.0 means that the target of the Measurement Tool is not visible at the moment.

- $b_0 \dots b_8$ form a rotation matrix according to the scheme described in chapter B.2.3 on page 162.
- $\sigma_{11} \dots \sigma_{33}$ denote the (symmetric) covariance matrix Σ of the Measurement Tool tip, given in units mm^2 :

$$\Sigma = \begin{pmatrix} \sigma_{11} & \sigma_{12} & \sigma_{13} \\ \sigma_{12} & \sigma_{22} & \sigma_{23} \\ \sigma_{13} & \sigma_{23} & \sigma_{33} \end{pmatrix}$$

Example (one line):

```
6dmt2 1 1 [0 1.000 4 2.000] [326.848 -187.216 109.503] [0.911812 -0.038421
0.408806 0.095040 0.988324 -0.119094 -0.399457 0.147444 0.904817] [0]
[8.178e-04 9.166e-04 1.084e-03 4.463e-02 9.025e-03 1.286e-02]
```

B.2.8 Measurement Tool references

Identifier 6dmtr.



Only available, if the Measurement Tool license is present for DTrack2 (available since version v2.2.0)

The output for Measurement Tool references is defined as follows:

- The first number gives the number of defined Measurement Tool references.
- The second number gives the number of tracked Measurement Tool references.
- The data of each tracked reference show up in blocks (three consecutive `[]`), like:

```
[id qu] [s_x s_y s_z] [b_0 b_1 b_2 b_3 b_4 b_5 b_6 b_7 b_8]
```

They contain:

1. ID number (`id`, starting with 0), quality value (`qu`, see below),
 2. Measured position (s_i) of the Measurement Tool reference,
 3. Rotation matrix (b_i) of the Measurement Tool reference.
- The quality (`qu`) can (so far) just get the values 1.0 and -1.0 . -1.0 means that the Measurement Tool reference is not visible at the moment.
 - $b_0 \dots b_8$ form a rotation matrix R according to the scheme described in chapter B.2.3 on page 162.

Example (one line):

```
6dmtr 1 1 [0 1.000] [-485.245 -67.217 -38.328] [0.681257 -0.315034
0.660790 -0.477531 -0.875410 0.074967 0.554845 -0.366620 -0.746817]
```

B.2.9 Measurement Tools (Old Format)

Identifier 6dmt.



Note: supported just for compatibility. It is recommended to use the newer Measurement Tool format 6dmt2 (see chapter B.2.7 on page 166) whenever possible.



Only available, if the Measurement Tool license is present for DTrack2 (available since version v2.2.0)

The output for Measurement Tools is similar to the format for Flysticks:

- The first number gives the number of defined Measurement Tools .
- The data of each tool show up in blocks (three consecutive []), like:

$$[id \text{ qu } bt] [s_x \ s_y \ s_z] [b_0 \ b_1 \ b_2 \ b_3 \ b_4 \ b_5 \ b_6 \ b_7 \ b_8]$$

They contain:

1. ID number (*id*, starting with 0), quality value (*qu*, see below) and button information (*bt*, unused),
 2. Measured position (s_i) of the tip,
 3. Rotation matrix (b_i) of the tip's orientation.
- The quality (*qu*) can (so far) just get the values 1.0 and -1.0. -1.0 means that the target of the Measurement Tool is not visible at the moment.
 - The protocol is prepared for future Measurement Tools equipped with buttons (like Flysticks). Until then *bt* is set to zero.
 - $b_0 \dots b_8$ form a rotation matrix R according to the scheme described in chapter B.2.3 on page 162.

Example (one line):

```
6dmt 1 [0 1.000 0] [326.848 -187.216 109.503] [0.911812 -0.038421
0.408806 0.095040 0.988324 -0.119094 -0.399457 0.147444 0.904817]
```

B.2.10 Additional 3DOF Markers

Identifier 3d.

The format of additional markers (all markers that don't belong to a 6DOF object) looks like a reduced format of standard bodies:

- The first number is the number of tracked additional markers.

- Blocks (two consecutive `[]`) follow for each marker:

$$[\text{id qu}] [s_x \ s_y \ s_z]$$

They contain ID number (`id`, starting with 1) and a quality value (`qu`, still unused), and the position (s_i).

Example (one line):

```
3d 6 [79 1.000] [210.730 -90.669 -108.554] [83 1.000] [61.235 -165.625
3.217] [87 1.000] [123.633 -107.836 0.110] [88 1.000] [212.383 -133.640
77.199] [90 1.000] [326.455 -187.055 109.589] [91 1.000] [303.185
-239.771 114.861]
```

B.2.11 Additional Informations

Identifier `6dca1`.

Optionally, the number of the adjusted bodies (not only of the tracked ones) can be included in a data set. This is done within an additional line like:

```
6dca1 3
```



Note that this number does not include all calibrated bodies. In particular, it counts the calibrated bodies that show up in the output lines `6d`, `6df` and `6dmt`.

Example (one line):

```
tfb 2 [0 0 1.0 0.5] [0 1 0.8 0.5]
```

List of Figures

2.1	Concept of optical tracking (stereo vision)	16
3.1	Angular range of visibility	21
4.1	SMARTTRACK	26
4.2	3D Visualization of the tracking volume	27
4.3	Attaching the T-piece to the SMARTTRACK	28
4.4	Typical situation arising from reflections through sunlight	30
4.5	Origin of the room coordinate system (default)	31
4.6	A room calibration set consisting of angle and wand	32
4.7	Room calibration process	33
4.8	Connecting the SMARTTRACK to a local network	35
5.1	Flystick2	36
5.2	Flystick2 control elements	37
5.3	Flystick2 - inserting the battery pack	38
5.4	Charging the battery of the Flystick2	39
5.5	Flystick3	40
5.6	Flystick3 control elements	41
5.7	Open the battery compartment of Flystick3	42
5.8	Insert new battery in Flystick3	43
5.9	Close the battery compartment of Flystick3	43
5.10	Flystick Settings	45
5.11	Measurement Tool	47
5.12	Measurement Tool Settings	49
5.13	Measurement Tool Tip Calibration	50
6.1	Inertial Sensor Settings - Connecting wireless transceivers	52
6.2	Dongle Configuration - Selection of a radio channel	53
6.3	Adding wireless inertial sensors	55
6.4	Inertial Sensor Settings - Wireless transceivers and sensors added	56
6.5	Inertial Sensor Settings - No wired inertial sensor connected	58
6.6	Adding wired inertial sensor	59
6.7	Inertial Sensor Settings - Wired inertial sensor added	59
6.8	Inertial Sensor Settings - Hybrid Bodies sub-dialogue	60
6.9	Hybrid Body Calibration	62
6.10	Hybrid Body Calibration - Progress Bar	62
6.11	Hybrid Body Calibration Result	62
6.12	Inertial Sensor Calibration	63

6.13	Inertial Sensor Calibration - Result Window	64
6.14	Inertial Sensor Calibration - Result Window Successful	64
6.15	Hybrid Tracking Settings - Inertial Sensors available (license necessary)	65
7.1	Welcome screen of DTrack2	70
7.2	Controller Selection	71
7.3	Welcome screen of DTrack2 with Wake On LAN option	73
7.4	Wake On LAN progress bar	73
7.5	Graphical user interface of DTrack2	78
7.6	Visualization of the synchronization frequency decrease	80
7.7	Monitor 2DOF view menu (e.g. camera 2)	82
7.8	Managing the licenses	87
7.9	Managing the configurations	88
7.10	Export System Information	89
7.11	Camera Settings	90
7.12	Synccard Settings	91
7.13	ART Radio Info Settings	93
7.14	Tracking Settings	94
7.15	Body Administration (from DTrack2 v2.9.0)	95
7.16	Filter Settings	98
7.17	Output settings	100
7.18	Depiction 'act as router' functionality	101
7.19	Advanced Controller Settings	102
7.20	Reflex suppression	105
7.21	Room calibration settings - SMARTTRACK	106
7.22	Marker distances (including numbering) on the angle and definition of room coordinate system	107
7.23	Room calibration progress	108
7.24	Room calibration result	109
7.25	Room re-calibration dialogue	110
7.26	Room adjustment dialogue (coarse)	111
7.27	Room adjustment dialogue (fine)	112
7.28	Room transform & matching dialogue	115
7.29	Recognized target in DTrack2 Monitor 2DOF display	115
7.30	Body calibration dialogue	116
7.31	Body Calibration Result	117
7.32	Defining the target coordinate system	118
7.33	Import of calibration files	120
7.34	Calibrate bodies with the target library	121
7.35	Body Adjustment	123
7.36	Update Assistant	127
7.37	Measurement Tool Demo	128
7.38	About DTrack2 Information	129
7.39	What's new Information	129
B.1	Allocation of ID number to the Flystick buttons	159

List of Tables

1.1	Symbols and their meaning	12
3.3	Standard targets overview	25
5.1	Description of the Flystick2	37
5.2	Status LEDs quick reference	40
5.3	Description of the Flystick3	41
5.4	Flystick settings - Description of the checkboxes and options	46
5.5	Measurement Tool settings	49
7.1	Command line parameters	70
7.2	Remote command strings	76
7.3	DTrack2 menu structure overview	80
7.4	Features of the <i>Monitor 2DOF view</i>	83
7.5	Menu <i>DTrack2</i>	86
7.6	Licenses overview	86
7.7	Menu <i>Settings</i>	90
7.8	Overview of the supported synccard modes	92
7.9	Overview of validated shutter glasses	92
7.10	Body Administration - Detailed description of the Controls	96
7.11	Body Administration - Detailed description	96
7.12	Filtering of 6DOF tracking data - Detailed description of the presets	98
7.13	Customizable preset 6DOF filtering - Detailed description of the parameters	99
7.14	Output identifiers	100
7.15	Menu <i>Calibration</i>	104
7.16	Defining the coordinate system for the room calibration	108
7.17	Menu <i>Display</i>	126
7.18	Menu <i>Tools</i>	126
7.19	Menu <i>About</i>	128

Index

- 3DOF markers, 94
- calibration
 - body calibration, **114**, 116, 121
 - body re-calibration, 121
 - calibration file, 119, **120**
 - room calibration, **32**, 105
 - room re-calibration, 109
- camera adjustment, 29
- center of gravity, 125
- coded flash, 21
- configuration management, 87
- controller, 33, 67
 - ARTTRACK Controller, 102
 - TRACKPACK Controller, 102
- coordinate system, 110

- Data Display, **83**
- data output, 100
- declaration of conformity, 147
- DHCP, 102

- field of view (FoV), **151**
- filtering 6DOF, 97
- flash intensity, 90

- infrared optical tracking system, 15
- interaction device
 - Flystick2, **36**, 101
 - Flystick3, **40**, 101
 - Measurement tool, **47**, 101, 125
- IP address, **75**

- liability, 145
- license code, 86
- line of sight, 40, 44

- MAC address, 72, **102**
- marker
 - active marker, 19
 - big active flat marker, 20
 - big active spherical marker, 20
 - passive marker, 18
- measurement volume, 33
- modulated flash, **91**
- Monitor 2DOF, **81**, **125**
- MultiUser option, **46**

- radio module, 40, 44
- reflex suppression
 - automatic, **104**
 - manual, **104**
- remote PC, 67
- retro reflector, 19
- rigid body, 22
- room calibration set, 32

- send data divisor, 100
- sensor fusion, 52
- service and support, 145
- Settings, 90
- shutter glasses (validated), 92
- SMARTTRACK, **26**
- software
 - DTrack2, **67**, 67
 - Overview, 78
- standby mode, 89
- synccard
 - Synccard2, 91
 - Synccard3, 91
 - SynccardTP, 91
- synchronization
 - active marker synchronization, 20

- targets, 22
- timestamp, 100, **162**
- tip calibration, 160
- tracking, 94
- trademarks, 2

Index

virtual point cloud, 33

Wake On LAN (WOL), **72**, 131

wake-on-power (WOP), 131

wand, **32**, 106

warranty, 145