



ART Hardware Installation Guide

ARTTRACK, TRACKPACK, SMARTTRACK & DTRACK

Trademarks

The following overview shows the registered trademarks of Advanced Realtime Tracking GmbH & Co. KG:

trademarks	illustrated as	in Germany	in the EU	in the U.S.
A.R.T. [®]	<i>ART</i>	×		
ART [®]	<i>ART</i>	×	×	×
ARTtrack [®]	<i>ARTTRACK</i>	×	×	×
DTrack [®]	<i>DTRACK3</i>	×		
smARTtrack [®]	<i>SMARTTRACK</i>	×		×
ART Advanced Realtime Tracking		×	×	×
ART Advanced Realtime Tracking		×	×	×

Microsoft[®] and Windows[®] are trademarks registered in the United States and other countries by the Microsoft Corporation.

The company names and product names written in this manual are trademarks or registered trademarks of the respective companies.

Warranty regarding further use of open source software

Advanced Realtime Tracking GmbH & Co. KG (denoted as **ART**) provides no warranty for the open source software programs contained in this product, if such programs are used in any manner other than the program execution intended by **ART**. The licenses define the warranty, if any, from the authors or licensors of the open source software. **ART** specifically disclaims any warranties for defects caused by altering any open source software program or the product's configuration. You have no warranty claims against **ART** in the event that the open source software infringes the intellectual property rights of a third party. Technical support, if any, will only be provided for unmodified software. The full license text can be obtained from **ART** directly.

Disclaimer

In no event shall Advanced Realtime Tracking GmbH & Co. KG be liable for any incidental, indirect, or consequential damages whatsoever (including, without limitation, damages for loss of business profits, business interruption, loss of business information, or any other pecuniary loss) arising out of the use of or inability to use the software or hardware.

©1999 - 2023 by Advanced Realtime Tracking GmbH & Co. KG



Advanced Realtime Tracking

Advanced Realtime Tracking GmbH & Co. KG

Am Öferl 6

82362 Weilheim i. OB

Germany

☎ +49 (0)881-92530-00

📠 +49 (0)881-92530-01

🏠 <http://ar-tracking.com>

Edition May 2023

The following new features are available:

- Support of up to 80 cameras

Edition June 2022

The following new features are available:

- Simplified camera licensing for Cascaded Systems

Edition October 2021

The following products have been added:

- ***SMARTTRACK3/M***

The following new features are available:

- Approx 30% increased tracking range for ***ARTTRACK6/M***

Edition May 2021

The following products have been added:

- ***ARTTRACK6/M for Active Markers***
- ***Flystick2+***

Edition January 2021

The following products have been added:

- ***ARTTRACK6/M*** Installation

Edition May 2020

The following products have been added:

- ***ART Controller/M*** Installation

Edition October 2019

The following products have been added:

- ***SMARTTRACK3*** Installation including Cascaded System capability

Contents

Terms and definitions	9
1 Safety	12
1.1 Symbols and their meaning	12
1.2 Warnings	12
1.2.1 Installation	12
1.2.2 Mounting	13
1.2.3 Operation	14
1.2.4 Maintenance	15
1.2.5 Disposal & Recycling	16
2 General Information	17
2.1 Cleaning of the equipment	17
2.2 Maintenance and service	17
2.3 Disposal and recycling of equipment	17
2.4 Disposal and recycling of batteries	19
2.5 Warranty	20
2.6 Liability	20
3 Introduction to tracking	22
4 Hardware Components	25
4.1 Cameras	25
4.1.1 ARTTRACK6/M	25
4.1.1.1 ARTTRACK6/M for Active Markers	26
4.1.2 ARTTRACK5	26
4.1.3 ARTTRACK5/C	27
4.1.4 TRACKPACK/E	28
4.2 Controller	28
4.2.1 ART Controller	28
4.2.2 ART Controller/M	29
4.2.3 Compatibility	31
4.3 Integrated systems	31
4.3.1 SMARTTRACK3 & SMARTTRACK3/M	31
4.4 Other equipment	33
4.4.1 PoE+ switch for larger systems	33
4.4.2 RadioTransceiver2/3	34
4.5 Discontinued hardware	35
4.5.1 ARTTRACK2	35
4.5.2 ARTTRACK3	35

4.5.3	TRACKPACK	36
4.5.4	TRACKPACK/C	37
4.5.5	SMARTTRACK2	38
5	System setup	40
5.1	Setting up the cameras	40
5.1.1	Camera orientation	40
5.1.2	Localizing and removing of disturbing reflections	40
5.1.3	Mutual blinding	41
5.1.3.1	Assigning syncgroups (available for ART Cameras and SMART-TRACK3 & SMARTTRACK3/M cascades only)	42
5.1.4	Static reflex suppression	43
5.1.5	Room Calibration - Overview	43
5.1.5.1	Room calibration - integrated systems	43
5.1.5.2	Room calibration - multi-camera setups	43
5.1.5.3	Room calibration hardware	45
5.1.5.4	Room calibration process	45
5.1.6	Mounting the cameras	46
5.1.6.1	General requirements	46
5.1.6.2	Tripod mounting	47
5.1.6.3	Wall mounting	47
5.1.6.4	Mounting the ARTTRACK6/M	48
5.1.6.5	Mounting the ARTTRACK5	49
5.1.6.6	Mounting the ARTTRACK5/C	49
5.1.6.7	Mounting the TRACKPACK/E	51
5.1.6.8	Mounting the SMARTTRACK3 & SMARTTRACK3/M	51
5.1.7	Installation of cables	51
5.2	Installation of the Controller	52
5.2.1	Installation of the ART Controller	52
5.2.2	Ports & Plugs on the ART Controller	53
5.2.3	Installation of the ART Controller/M	55
5.2.4	Ports & Plugs on the ART Controller/M	56
5.2.5	Connecting cameras	58
5.2.5.1	Connection of ARTTRACK6/M , ARTTRACK5 , ARTTRACK5/C or TRACKPACK/E cameras	58
5.2.5.2	Connection of ARTTRACK1 , ARTTRACK2 or ARTTRACK3 cameras (backwards compatible systems)	60
5.2.6	Dynamically adding / removing of cameras	60
5.3	Installation of the SMARTTRACK3 & SMARTTRACK3/M	60
5.3.1	Ports & Plugs on the SMARTTRACK3	60
5.3.2	Connecting & starting the SMARTTRACK3	62
5.4	Connection to local network LAN	62
5.4.1	Connection to LAN using DHCP	63
5.4.2	Connection to LAN using a static IP address	63
5.5	Synchronization	65
5.5.1	Synchronization Input	65

5.5.2	Synchronization Output	65
5.6	Cascaded systems	66
5.6.1	Connecting a cascade	67
5.6.1.1	Connecting cascaded controllers	67
5.6.1.2	Starting the cascades	69
5.7	Markers and targets (rigid bodies)	75
5.7.1	Passive markers	75
5.7.2	Active markers	76
5.7.3	Standard targets	79
5.8	Interaction devices	83
5.8.1	Flystick2+	83
5.8.1.1	Control elements	84
5.8.1.2	Data output	85
5.8.1.3	Feedback control	85
5.8.1.4	Batteries	85
5.8.1.5	Charging jack	87
5.8.1.6	Battery charger	87
5.8.1.7	Radio module	87
5.8.2	Flystick2	88
5.8.2.1	Control elements	89
5.8.2.2	Data output	90
5.8.2.3	Battery pack	90
5.8.2.4	Charging jack	90
5.8.2.5	Battery charger	91
5.8.2.6	Radio module	92
5.8.3	FINGERTRACKING2	92
5.8.3.1	FINGERTRACKING2 and FINGERTRACKING2 Tactile Hand Targets	93
5.8.3.2	Finger thimble sets FINGERTRACKING2	96
5.8.3.3	Wireless synchronization	96
5.8.3.4	Battery charger	97
5.8.3.5	Data output	98
5.8.3.6	Tactile control	98
5.8.4	Measurement Tool	98
5.8.4.1	Data output	99
5.9	Discontinued hardware	100
5.9.1	Mounting the cameras	100
5.9.1.1	Mounting the ARTTRACK2 and ARTTRACK3 (discontin- ued)	100
5.9.1.2	Mounting the TRACKPACK (discontinued)	100
5.9.1.3	Mounting the TRACKPACK/C (discontinued)	100
5.9.1.4	Mounting the SMARTTRACK2 (discontinued)	100
5.9.2	Installation of the ARTTRACK Controller (discontinued)	101
5.9.3	Installation of the TRACKPACK Controller (discontinued)	103
5.9.4	Installation of the SMARTTRACK2 (discontinued)	104

5.9.5	Flystick3 (discontinued)	106
5.9.5.1	Control elements	107
5.9.5.2	Data output	108
5.9.5.3	Battery pack	108
5.9.5.4	Battery charger	109
5.9.5.5	Radio module	110
5.9.5.6	Wireless synchronization (active <i>Flystick3</i> discontinued)	110
5.9.6	Fingertracking (discontinued)	111
5.9.6.1	<i>Fingertracking</i> Hand Targets	112
5.9.6.2	Finger thimble sets <i>Fingertracking</i>	115
5.9.6.3	Wireless synchronization	115
5.9.6.4	Battery charger	116
5.9.6.5	Data output	116
6	Frequently asked questions (FAQ)	117
6.1	Cameras	117
6.2	Synchronization	119
A	Technical specifications	126
A.1	Cameras	126
A.1.1	<i>ARTTRACK6/M</i> and <i>ARTTRACK6/M for Active Markers</i>	126
A.1.2	<i>ARTTRACK5</i>	127
A.1.3	<i>ARTTRACK5/C</i>	128
A.1.4	<i>TRACKPACK/E</i>	129
A.2	Controller	130
A.2.1	<i>ART Controller</i>	130
A.2.2	<i>ART Controller/M</i>	131
A.3	Integrated Systems	132
A.3.1	<i>SMARTTRACK3</i> & <i>SMARTTRACK3/M</i>	132
A.4	<i>Flystick2</i> & <i>Flystick2+</i>	134
A.5	Fingertracking	135
A.5.1	<i>FINGERTRACKING2</i>	135
A.5.2	<i>FINGERTRACKING2 Tactile</i>	136
A.6	Discontinued products	136
A.6.1	<i>ARTTRACK</i> cameras	136
A.6.2	<i>TRACKPACK</i> cameras	138
A.6.3	<i>SMARTTRACK2</i>	139
A.6.4	<i>Flystick3</i>	140
A.6.5	<i>Fingertracking</i>	141
A.7	Overall system	141
A.8	Declaration of conformity	143
A.9	Declaration of conformity (discontinued products)	171
	List of Figures	182
	List of Tables	184

Terms and definitions

term	definition
3DOF	three degrees of freedom (i.e. only position)
6DOF	six degrees of freedom (i.e. position and orientation)
5DOF	five degrees of freedom (i.e. one degree less in orientation)
base	imaginary connecting line between two cameras (e.g. the two integrated cameras inside the <i>SMARTTRACK2/3/M</i>)
<i>ART Controller</i>	controller for rackmounting, calculates tracking data and generates the data output stream (compatible to <i>ARTTRACK2</i> , <i>ARTTRACK3</i> , <i>ARTTRACK5</i> , <i>ARTTRACK5/C</i> , <i>ARTTRACK6/M</i> , <i>TRACKPACK/E</i>)
<i>ART Controller/M</i>	compact size controller, calculates tracking data and generates the data output stream (compatible to <i>ARTTRACK2</i> , <i>ARTTRACK3</i> , <i>ARTTRACK5</i> , <i>ARTTRACK5/C</i> , <i>ARTTRACK6/M</i> , <i>TRACKPACK/E</i>)
<i>ARTTRACK</i> Controller (discontinued)	calculates tracking data and generates the data output stream (compatible to <i>ARTTRACK1</i> , <i>ARTTRACK2</i> , <i>ARTTRACK3</i>)
<i>ARTTRACK2</i> (discontinued)	infrared camera
<i>ARTTRACK3</i> (discontinued)	infrared camera
<i>ARTTRACK5</i>	infrared camera
<i>ARTTRACK5/C</i>	infrared camera dedicated for multi-sided projections
<i>ARTTRACK6/M</i>	infrared camera dedicated for compact environments or multi-sided projections
<i>ARTTRACK6/M for Active Markers</i>	flashless camera dedicated for use with active targets in compact environments or multi-sided projections
body calibration	teach the system the geometry of a rigid body
body, rigid body	rigid arrangement of multiple markers intended for 6DOF tracking (see also "target")
calibration angle	belongs to the room calibration set and defines origin and orientation of the room coordinate system
ceiling suspension	equipment to mount an infrared camera or <i>SMARTTRACK2/3/M</i> to the ceiling
<i>DTRACK3</i>	
backend software	software running on the <i>ART Controller</i> , <i>ART Controller/M</i> or <i>SMARTTRACK2/3/M</i> doing all necessary calculations
frontend software	graphical user interface running on customer's computer to control the <i>ART Controller</i> , <i>ART Controller/M</i> or <i>SMARTTRACK2/3/M</i>
Field of View (FoV)	is the area of interest captured on the camera's image
finger thimble	a fixture for the finger tip to hold the active marker(s) (not available for <i>SMARTTRACK2/3/M</i>)
<i>Fingertracking</i> (discontinued)	tracks the orientation of the hand and the position of the fingers (not available for <i>SMARTTRACK2/3/M</i>)
<i>FINGERTRACKING2</i>	tracks the orientation of the hand and the position of the fingers (not available for <i>SMARTTRACK2/3/M</i>)
<i>FINGERTRACKING2 Tactile</i>	tracks the orientation of the hand and the position of the fingers and provides Tactile Feedback
<i>Flystick2/2+/3</i>	wireless interaction device for virtual reality (VR) applications
<i>Flystick</i> feedback	vibrational or acoustic signal that can be triggered in a capable <i>Flystick</i>
hand geometry	describes the dimensions of your hand and fingers (not available for <i>SMARTTRACK2/3/M</i>)

term	definition
hybrid tracking	sensor fusion of optical and inertial data into one consolidated output
inertial sensor	an inertial measurement unit simultaneously measures 9 physical properties, i.e. angular rates, linear accelerations (unused) and magnetic field components (unused) along all 3 axes. This is achieved using solid state gyroscopes for measurement of roll, pitch and yaw and optical tracking for drift correction.
infrared optical tracking	position measurement of bodies (subjects or objects) based upon infrared light and optical measurement procedures
license code (license key)	software key to unlock certain capabilities of the tracking system or SMARTTRACK2/3/M
marker	object either made of retro reflective material or LED for position tracking (3DOF)
Measurement Tool	a pointing device which allows to measure the position of the tool's tip with high accuracy
measurement volume	defines the volume where optical tracking is possible
modulated flash	infrared signal which is used for wireless synchronization
motion capture	track movements of a human body
mutual blinding	at least one camera (also from SMARTTRACK2/3/M) sees disturbing reflections caused by the infrared flashes of another camera (or SMARTTRACK3)
prediction	predicts output for the specified time in the future to compensate tracking and rendering latency
Radio Transceiver	exchange data with Flystick2/2+/3 (integrated in SMARTTRACK2)
RadioTransceiver2/3	uses USB port to exchange data with Flystick2/2+/3 or FINGERTRACKING2 Tactile
room calibration	teach the system the position of each camera and define origin and orientation of the room coordinate system
room calibration set SMARTTRACK3	consists of angle tool and wand fully integrated stand-alone infrared optical tracking system with two cameras and integrated controller, calculates tracking data and generates the data output stream
SMARTTRACK3/M	compact version of SMARTTRACK3
syncgroup	cameras being in one syncgroup receive the sync signal at the same time. Syncgroups are distinguished by a short time delay between their sync signals in order to avoid mutual blinding. (not available for SMARTTRACK2)
Synccard	unit integrated in SMARTTRACK2/3/M which serves for synchronizing the cameras
Synccard2	board integrated in the ARTTRACK Controller (discontinued) which serves for synchronizing the cameras
Synccard3	board integrated in the ART Controller or ART Controller/M which serves for synchronizing the cameras
SynccardTP	board integrated in the TRACKPACK Controller (discontinued) which serves for synchronizing the cameras
Tactile Feedback	system for finger-based interactions in immersive virtual reality applications (wires touch the inside of the finger tips and provide an impression when they are shortened)
target	rigid arrangement of multiple markers intended for 6DOF tracking (see also "rigid body")
tracking	position measurement of bodies that move in a defined space
TRACKPACK (discontinued)	infrared camera
TRACKPACK/C (discontinued)	infrared camera dedicated for multi-sided projections

term	definition
<p><i>TRACKPACK/E</i> <i>TRACKPACK</i> Controller (discontinued) virtual point cloud</p>	<p>infrared camera calculates tracking data and generates the data output stream (compatible to <i>TRACKPACK</i> and <i>TRACKPACK/C</i>) used for calculating the relative position of cameras or <i>SMART-TRACK2/3/M</i> that cover the measurement volume</p>
wand	<p>precalibrated stick carrying two markers. The wand belongs to the room calibration set and is used to generate a virtual point cloud and to scale the measurement volume</p>

1 Safety

1.1 Symbols and their meaning

You can find the following symbols and signs on the equipment or in the manual:





	Useful and important notes.
	Important notes, which may lead to system malfunction or to the loss of warranty by non-observance.
	Important safety warning to assure user's and operational safety. These warnings have to be observed, otherwise there is a potential risk for health and safety and damaging of the equipment resulting in loss of warranty and liability.
	Safety warning for infrared radiation. These warnings have to be observed, otherwise the user's eyes and sight are exposed to a potential hazard.

Table 1.1: Symbols and their meaning

1.2 Warnings



All warnings in this manual have to be observed for safe operation of the equipment.



ART explicitly denies any warranty and liability if the product is not operated according to this manual or any other authorised documentation (e.g. quick-guides) or not according to the specifications of the equipment.

1.2.1 Installation



The housing may NOT be damaged.



Do not install or use any equipment when it shows signs of damage (e.g. smoke, sparks, fire, smells, etc) or if parts of it show damaging.

1 Safety



Do not install or use any equipment when the power cord is damaged.



Insert batteries in the indicated polarity !



Some equipment employs connectors of proprietary design. Do not try to connect these to any other computer ports (e.g. COM port or LAN) !!!



Verify that voltage and frequency of your electrical grid comply with the appliance ratings of the equipment. The rating plates are found on the equipment's housing. (*ARTTRACK1* on the lower side of the housing; *ARTTRACK2 / ARTTRACK3* and *SMARTTRACK2/3/M* on external power supply, all controllers on the rear side of the housing).



The equipment may only be powered from power sockets connected to earth/ground. If the grounding wire is defective the requirement of the safety and the electromagnetic compatibility (EMC) cannot be guaranteed. To check the function of the grounding wire ask your local electrician.



The power switch on the equipment does not separate the device from mains. The equipment must be disconnected from mains.

1.2.2 Mounting



Do not touch the front pane of the cameras. The acrylic pane and the lens have highly sensitive surfaces. Be careful to avoid permanent damages (e.g. scratches). Grab the cameras only on the housing.



Shock and severe vibrations can permanently damage the internal calibration of the cameras. De-calibrated cameras have to be sent in for maintenance.



The power cord and plug should be accessible freely. The power socket should be close to the equipment.



Install the cables that the line of sight of the cameras or *SMART-TRACK2/3/M* is not obstructed.



Do not drop the equipment.



Be sure that the cameras are firmly mounted using strong wall plugs / anchors and screws when mounting to walls or ceilings. Loosely mounted cameras may pose a serious hazard to health and safety.



Never unfasten screws that are not designed for mounting. All liability and warranty is void.



Use only accessories for mounting (screws, ceiling suspension) supplied by *ART*.



The ventilation holes of the equipment (particularly of *SMART-TRACK2*, *ARTTRACK2*, *ART Controller* and *ART Controller/M*) must not be covered. Ensure unblocked airflow at all times. The minimum distance between equipment and surrounding objects has to be larger than 3 cm.



Install a strain relief to all cables to avoid damage to the equipment.



Install the cables trip-proof (e.g. cable ducts or fixings). Inappropriate cabling may pose a serious hazard to health and safety.

1.2.3 Operation



Unplug the equipment from mains immediately in any case of damage ! Please contact *ART* service



Removable batteries must be removed before shipping equipment.



Batteries should be removed when equipment is not used for a longer period of time - Risk of damage !



Do not use non-rechargeable batteries in rechargeable equipment (e.g. *Flystick2*) - Risk of explosion !



Do not crush or puncture batteries and avoid impact that might result in damage, leakage or short-circuiting.



Use only original components and accessories from *ART* or authorized by *ART*. Using unauthorized components or accessories may damage the equipment, may cause malfunctioning and may compromise operational safety.



In case connectivity is provided using third party equipment please ensure compliance to all applicable standards regarding connectivity and power supply (see chapter A on page 126). Non-compliance may result in loss of conformity ! All warranty and liability is void.



Only peripheral devices which meet the safety requirements of UL 60950-1 (U.S. only) and EN / UL / IEC 62368-1 (EU, U.S., etc.) for SELV may be attached on Ethernet-, BNC- and the DC-circuit of the equipment.

1 Safety



Do not expose the equipment to high levels of humidity or condensing environments.



The equipment must not be operated in environments with intensive formation of dust.



The equipment must not be operated in environments with elevated temperatures above 40° C (100° F).



Do not use the equipment outdoors (i.e. outside of buildings or potentially moist / wet locations) !



Do not spill fluids over the equipment!



Do not insert objects into the equipment (e.g. ventilation openings) !



Do not change or modify the equipment in any way (e.g. mechanically, electrically). Non-compliance may result in loss of conformity ! All warranty and liability is void.



The cameras and *SMARTTRACK2/3/M* emit infrared light. Keep a distance of min. 20 cm when operating near cameras or *SMARTTRACK2/3/M*. All cameras and *SMARTTRACK2/3/M* are assigned to the Exempt Group according to IEC62471-1 and therefore pose no risk or hazard to the human eye or skin at this distance.

1.2.4 Maintenance



Only the housing of the cameras may be cleaned. Before cleaning shut down the system and disconnect the power cords.



Do not use any solvents, water or chemicals to clean the cameras!



Do not try to repair anything by yourself!



Danger High Voltage inside the equipment ! Do not open the equipment ! Risk of electric shock - even if the equipment is disconnected. Please contact *ART* service.



All warranty and liability is void when the equipment is opened.



In order to replace mains fuses (e.g. *ART Controller*) always unplug the power cord first. Risk of electric shock !



Risk of explosion if removable batteries are replaced by an incorrect type!

1.2.5 Disposal & Recycling



Waste Electronic and Electrical Equipment (WEEE) should never be disposed of along with household waste.



Batteries should never be disposed of along with household waste.



Batteries or rechargeable batteries that are not permanently installed must be removed beforehand and disposed of separately.



To prevent fires due to short-circuits, tape battery terminals and/or place lithium-ion batteries in separate plastic bags.



Do not crush or puncture used batteries and avoid impact that might result in damage, leakage or short-circuiting.

2 General Information

2.1 Cleaning of the equipment



Use a dry, lint-free and antistatic cloth or tissue (e.g. lens-cleaning tissue for optical equipment).



Only the housing of the cameras may be cleaned. Before cleaning shut down the system and disconnect the power cords.



Do not use any solvents, water or chemicals to clean the cameras!

2.2 Maintenance and service

Routine maintenance of the equipment is recommended every three years. If you experience any problems please do not hesitate to contact our support.



Do not try to repair anything by yourself!



Danger High Voltage inside the equipment ! Do not open the equipment ! Risk of electric shock - even if the equipment is disconnected. Please contact *ART* service.



All warranty and liability is void when the equipment is opened.

2.3 Disposal and recycling of equipment

Waste Electronic and Electrical Equipment (WEEE) may contain a complex mixture of materials and hazardous substances. If not managed properly and thus exposed, these can cause serious damage to the environment, wildlife, and human health. In addition, modern electronics contain rare and expensive resources, which can be recycled and re-used to contribute to the circular economy. By ensuring that you dispose of WEEE properly, you are helping to improve sustainable production and consumption, to increase resource efficiency and to preserve our natural resources and protect human health.

The symbol (crossed-out wheelie bin symbol according to Waste Electronic and Electrical Equipment (WEEE) Directive 2012/19/EU, see figure 2.1 (a) or (b) on page 18) indicates

that the product should not be discarded as unsorted municipal waste but must be sent to separate collection facilities for recovery and recycling.

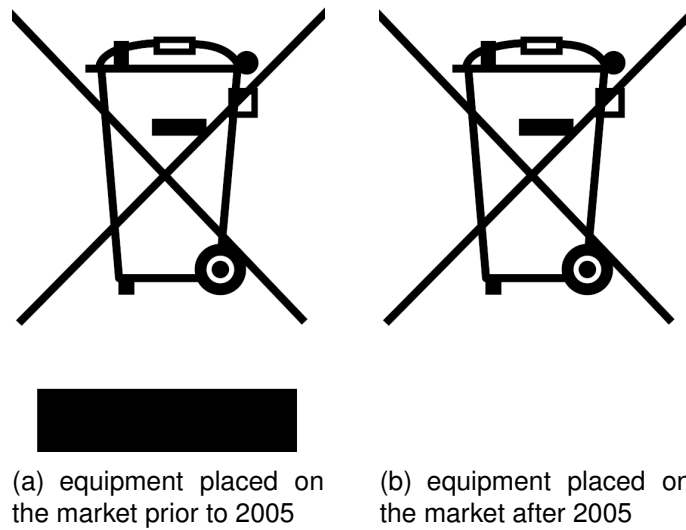

Figure 2.1: WEEE label

When your delivery address is outside of Germany, dispose of WEEE at your local waste facilities or recycling centers available by public waste management authorities only. Please consider that local regulations on the disposal of and recycling of electronic and electrical equipment may apply. Contact your local authority directly for more information.

For deliveries inside Germany only:

- End-users of WEEE are obliged to return the equipment or have it collected within the framework set up by **ART**.
- You are responsible for deleting personal or confidential data from the equipment to be disposed of. You can do this by resetting the device to its factory settings. Please refer to **DTRACK3 User's Guide** → *Connecting to the controller* → *Configuring your controller's network address without network access* for more details. **ART** is not liable for any data on your device. Before resetting your device, you should always back up any sensitive data.
- For further details regarding the WEEE directive, including how **ART** ensures the safe disposal of your electrical and electronic equipment, please refer to our website at <https://ar-tracking.com/de/art-geraete-ruecknahmekonzept>



Waste Electronic and Electrical Equipment (WEEE) should never be disposed of along with household waste.

2.4 Disposal and recycling of batteries

Batteries are made from important resources, including lead, cadmium, zinc, lithium and mercury. Many of the components of these batteries and rechargeable batteries could be recycled, avoiding the exposure of hazardous substances to the environment. In addition, by recycling your used batteries using the collection and recycling schemes available you are contributing to protecting Earth's natural resources by providing valuable materials to products and production processes.

The symbol (crossed-out wheeled bin symbol according to Battery Directive 2006/66/EC, see figure 2.1 (b) on page 18) indicates that you are legally obliged to dispose of batteries or rechargeable batteries separately from unsorted municipal waste, i.e. that they must be disposed of separately from household waste. If batteries or rechargeable batteries contain Mercury (Hg), Cadmium (Cd) or Lead (Pb), they are marked with the chemical symbols of the metals (Hg, Cd, Pb) for which the limit value is exceeded.

- Pb = battery contains more than 0.004 mass percent Lead
- Cd = battery contains more than 0.002 mass percent Cadmium
- Hg = battery contains more than 0.0005 mass percent Mercury

When your delivery address is outside of Germany, dispose of used batteries at dedicated battery collection points or recycling centers available by public waste management authorities only. Please consider that local regulations on the disposal of and recycling of batteries may apply. Contact your local authority directly for more information.

For deliveries inside Germany only:

- End-users of batteries are obliged to recycle used batteries via dedicated battery collection points or recycling centers set up by public waste management authorities or via retailers directly. Addresses of suitable collection points and recycling facilities in your area can be obtained from your city or by contacting your local authorities.
- For further details regarding the Battery Directive, please refer to our website at <https://ar-tracking.com/de/art-geraete-ruecknahmekonzept>



Batteries should never be disposed of along with household waste.



Batteries or rechargeable batteries that are not permanently installed must be removed beforehand and disposed of separately.



To prevent fires due to short-circuits, tape battery terminals and/or place lithium-ion batteries in separate plastic bags.



Do not crush or puncture used batteries and avoid impact that might result in damage, leakage or short-circuiting.

2.5 Warranty

General Please refer to the terms & conditions on our website at <https://ar-tracking.com/en/terms-agb>

Hardware **ART** warrants the hardware to be free from defects in material and workmanship, design and manufacturing for the warranty period set forth in our terms & conditions (see website) after the time of delivery. The time of delivery is defined as the day when the end-user takes possession of the equipment. If **ART** or any third party authorized by **ART** installs the system, the time of delivery is the time of the first installation.

If a defect arises during this warranty period, provided the instructions for returning the hardware are followed, **ART** will, to the extent permitted by law, initially either (i) repair or (ii) replace the hardware or any defective parts. All replaced parts and hardware shall become property of **ART**. This limited warranty applies only to hardware components that have been under ordinary and intended use and service being in their original, unmodified state and thus have not been subject to damage from external causes, alteration or unauthorized repair.

Software Software supplied is delivered on a tested "As Is" basis. **ART** explicitly does not warrant that the software is error (bug) free. If the user detects bugs and notifies **ART**, **ART** will provide a workaround or bug fix as soon as possible after successfully reproducing the error.

Warranty restrictions All warranty and liability is void, if the equipment

- is not operated according to this manual or any other authorized documentation (e.g. quick-guides),
- has not been used according to the specifications of the equipment,
- shows damages or signs of improper use,
- has been opened by the user or other non-authorized personnel (non-members of **ART** and third parties not authorized by **ART**),
- has been modified or tampered with by the user or other non-authorized personnel (non-members of **ART** and third parties not authorized by **ART**).

2.6 Liability

General Please refer to the terms & conditions on our website at <https://ar-tracking.com/en/terms-agb>

In no event shall **ART** be liable for any incidental, indirect or consequential damages whatsoever (including, without limitation, damages for loss of business profits, business

2 General Information

interruption, loss of business information, or any other pecuniary loss) arising out of the use of or inability to use the software or hardware.

Measurement results *ART* products are not authorized for use under any circumstance where human life might be at risk due to malfunction, measurement errors or interrupted operation of the system without written approval of a managing director of *ART*.

It is the user's sole responsibility to check the results of the measurement data and to protect any downstream system against malfunction, measurement errors or interrupted operation of the system. Under no circumstances shall *ART* be held liable for any incidental, indirect or consequential damages whatsoever (including, without limitation, damages for loss of business profits, business interruption, loss of business information, or any other pecuniary loss) arising out of malfunction, measurement errors or interrupted operation of the system.



***ART* explicitly denies any warranty and liability if the product is not operated according to this manual or any other authorized documentation (e.g. quick-guides) or not according to the specifications of the equipment.**



Do not change or modify the equipment in any way (e.g. mechanically, electrically). Non-compliance may result in loss of conformity ! All warranty and liability is void.

3 Introduction to tracking

The **ART** tracking systems are infrared (IR) optical tracking systems, whereas the **SMART-TRACK2/3/M** are fully integrated stand-alone tracking systems, designed to be used in small volumes (approx. 2m^3). In this user manual we are going to perceive "tracking" as measurement of positional and rotational information (i.e. orientation) of objects or individuals that move in a defined space.

Concept of optical tracking The cameras send out synchronized IR flashes which are reflected back into the lens by retro-reflective material covering the markers of the target. The reflected IR light is detected by the tracking cameras (integrated in **SMART-TRACK2/3/M**) which create a greyscale image based on the received IR radiation. In the next step these images are preprocessed by the cameras to calculate the marker positions (2DOF) on the camera sensor with high accuracy using pattern recognition algorithms. Then this 2DOF data is sent to a control unit to calculate 3DOF or 6DOF information.

The simultaneous measurement of spatial position (X, Y, Z) and orientation (three independent angles) is called 'six degrees of freedom' (6DOF) tracking. If only the spatial position (X, Y, Z) is to be measured it is called 'three degrees of freedom' (3DOF) tracking.

Single markers are sufficient if only 3DOF coordinates are needed, but single markers cannot be distinguished in principle. An ID is assigned to a tracked 3DOF marker as long as it can be followed, but after losing the tracking (e.g. due to occlusions) one would not be able to re-identify the marker and thus a new ID will be assigned. For 6DOF tracking, however, a unique target is mandatory. Targets are rigid arrangements of markers (=rigid bodies) and thus can be identified by their relative marker position. Figure 3.1 on page 23 shows the concept of infrared optical tracking with a two-camera system and a standard target.

The base for this calculation is that the cameras' field of views are overlapping. In a two-step teaching process, the position and orientation of the cameras is made known to the system (the 'room calibration'), after which the system is taught to identify the unique arrangements of markers as targets (the 'body calibration'). Then the paths of the optical rays from the cameras to the markers are calculated to deliver the ray intersections in three-dimensional coordinates. These intersections are the positions of the markers. Based upon this, one is able to calculate 6DOF data and, finally, knows position and orientation of the target and therefore the object or individual to be tracked.

The **SMARTTRACK2/3/M** make use of the same principle.

Note: In pure optical tracking systems tracking is only possible as long as

- objects or individuals to be tracked are equipped with single markers or targets
- the target is not occluded by any other objects in the cameras' line of sight, which could even be the object itself
- the target is positioned inside the tracking range of the cameras
- at least four markers of a target are visible to at least two cameras (this step enables tracking).

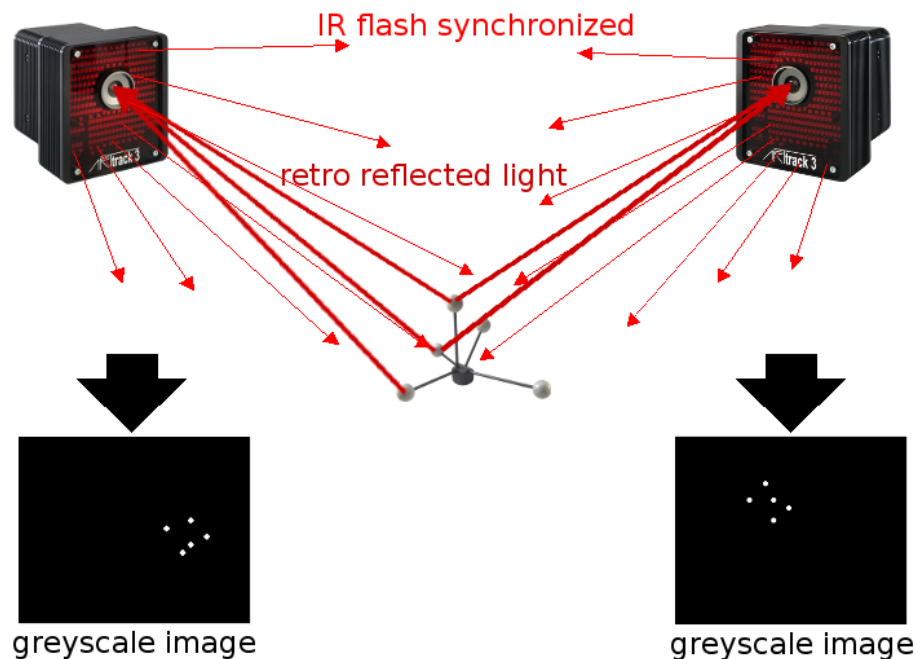

Figure 3.1: Concept of optical tracking (stereo vision)



The *SMARTTRACK2/3/M* have a limited field-of-view and range! It is designed to be used in small volumes. Please refer to 4.3.1 on page 31 for more information on the tracking volume of the *SMARTTRACK2/3/M*.

Marker types Passive markers are covered with retro reflective material - they act as light reflectors. Active light emitters (i.e. based on infrared LEDs) are called active markers (see chapter 5.7 on page 75).

Hybrid tracking In addition to tracking by a pure optical system it is possible to utilize data from inertial measurement units (IMU). These devices usually consist of several components such as gyroscopes, accelerometers and magnetometers. The underlying principle is the combination of solid-state microelectromechanical systems with integrated circuits and analog or digital outputs to achieve 6DOF rotational information.

Some of the most important advantages of hybrid tracking are:

- tracking data from IMUs offers low noise-levels while running at very high frequencies in combination with low latencies
- IMUs deliver tracking data (i.e. rotational information) even when the optical target is not inside the tracking volume or if the target cannot be tracked due to viewing limitations or occlusions
- drifting of IMUs (i.e. mostly from the 3-axis gyroscope) is compensated by fusing the inertial data with position measurements calculated from the optical tracking system

A hybrid target is basically an optical target additionally equipped with an IMU, which itself is connected to the controller or *SMARTTRACK2/3/M*.

There the tracking data from both worlds (i.e. hybrid) is combined, which also leads to the term 'sensor fusion'. By nature the IMU contains an independent coordinate system which needs to be aligned to the optical tracking system axes. This additional teaching process is called hand-eye calibration or 'hybrid body calibration' in *DTRACK3*.

Tracking with *DTRACK3* All *ART* systems are based on a controller (stand-alone or integrated controller in *SMARTTRACK2/3/M*) which operates cameras, interaction devices (optional) and targets respectively. The cameras (refer to chapter 4.1 on page 25) and the interaction devices (refer to chapter 5.8 on page 83) have to be connected to the respective ports of the controller.

The software *DTRACK3* consists of frontend and backend software.

The backend software runs on the controller - all necessary calculations (3DOF, 6DOF data, etc.) are performed there. The data and control commands are interchanged via ethernet (TCP/IP connection) between the controller and the *DTRACK3* frontend software on the remote PC. *DTRACK3* frontend offers a GUI for easy handling that enables the user to control the tracking system at a distance. The benefit is that the system becomes more flexible, i.e. different users can control the tracking system at any one time (but not simultaneously!) from different working places.

Data output to the application or graphics workstation is also done via ethernet (UDP/IP connection).

Furthermore, *DTRACK3* provides the possibility to control the functions in the backend via ethernet (i.e. without the *DTRACK3* frontend software). This is also done by establishing a TCP/IP connection with the controller and exchanging short command strings (refer to the *DTRACK3 Programmer's Guide*).

4 Hardware Components

4.1 Cameras

4.1.1 ARTTRACK6/M



Keep a distance of min. 20 cm when operating the camera ! The camera is assigned to the Exempt Group according to IEC62471-1 and therefore poses no risk or hazard to the human eye or skin at this distance.

Description The *ARTTRACK6/M* infrared camera is intended for working environments with distances between camera and markers of up to 3.5 metres (see figure 4.1 on page 25). By default the *ARTTRACK6/M* is equipped with a 2.9 mm lens. Depending on the application and the setup the *ARTTRACK6/M* can be equipped with other lenses (i.e. with different focal lengths). Refer to A.1 on page 126 for a list of available focal lengths and the respective Field of View.

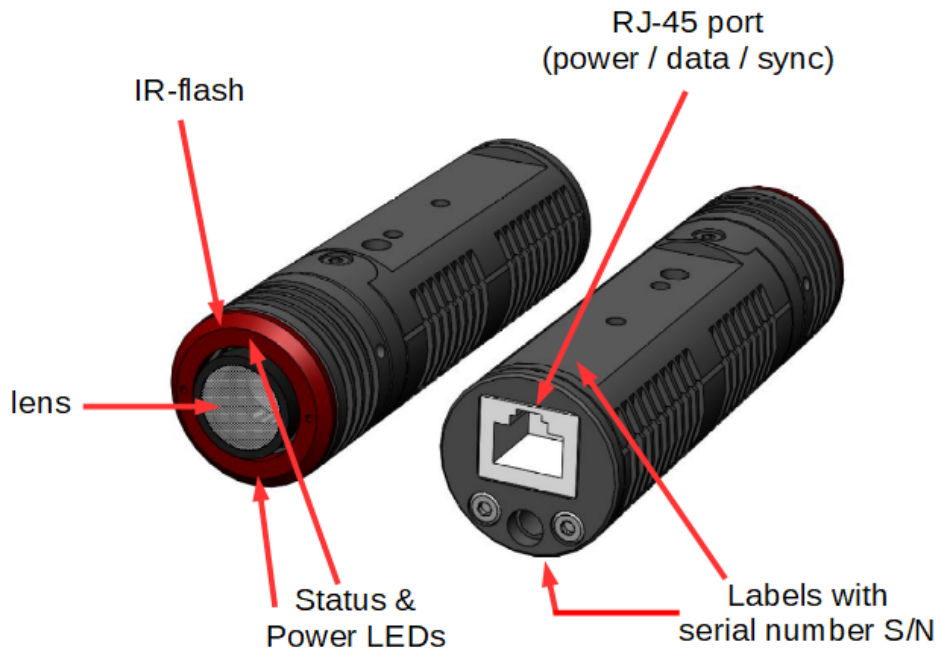

Figure 4.1: Camera *ARTTRACK6/M* - Description of LEDs and interface connectors

4.1.1.1 *ARTTRACK6/M for Active Markers*

Description The *ARTTRACK6/M for Active Markers* camera is intended for use with active markers only. It features the same specifications (dimensions, working environment, available focal lengths of lenses, field of view, etc.) as the *ARTTRACK6/M* but lacks an infrared flash. Therefore it cannot be used in combination with passive markers. Please refer to chapter 5.7 on page 75 for further details regarding marker types.

4.1.2 *ARTTRACK5*



Keep a distance of min. 20 cm when operating the camera ! The camera is assigned to the Exempt Group according to IEC62471-1 and therefore poses no risk or hazard to the human eye or skin at this distance.

Description The *ARTTRACK5* infrared camera is intended for working environments with distances between camera and markers of up to 7.5 metres (see figure 4.2 on page 26). By default the *ARTTRACK5* is equipped with a 3.5 mm lens. Depending on the application and the setup the *ARTTRACK5* can be equipped with other lenses (i.e. with different focal lengths). Refer to A.1 on page 126 for a list of available focal lengths and the respective Field of View.

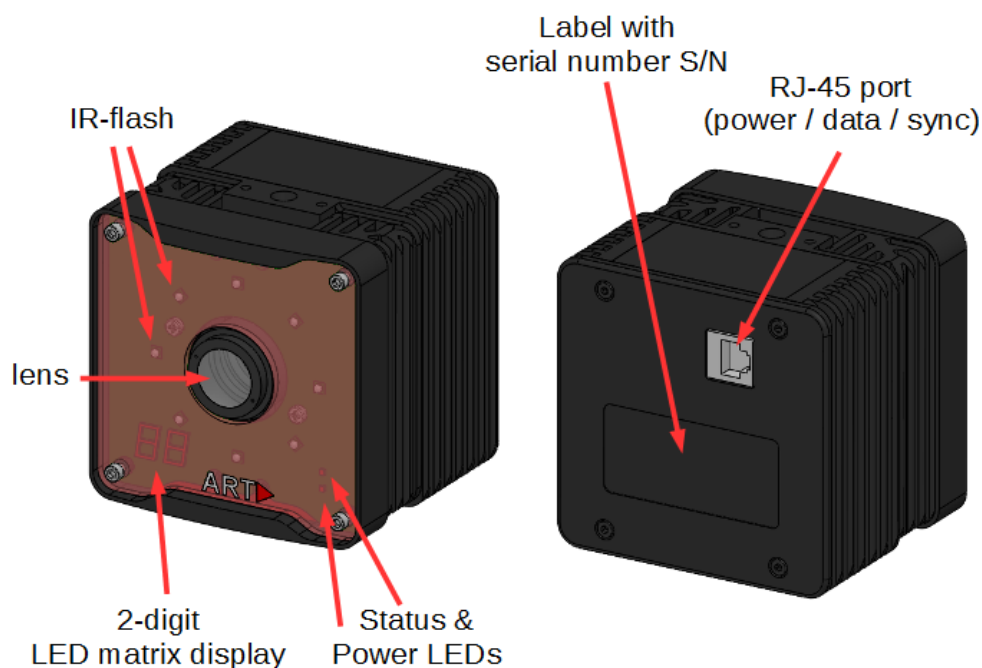

Figure 4.2: Camera *ARTTRACK5* - Description of LEDs and interface connectors

4.1.3 ARTTRACK5/C



Keep a distance of min. 20 cm when operating the camera ! The camera is assigned to the Exempt Group according to IEC62471-1 and therefore poses no risk or hazard to the human eye or skin at this distance.

Description The *ARTTRACK5/C* camera is designed for tracking in multi-sided projection environments (e.g. CAVE®, I-Space). In such an environment it is necessary to drill holes into the projections' corners. The *ARTTRACK5/C* camera has been designed to easily fit into such holes by separating the lens from the electronics part (see figure 4.3 on page 27). With its 4.0 mm lens a large field of view (FoV) is covered. Refer to A.1 on page 126 for more information.

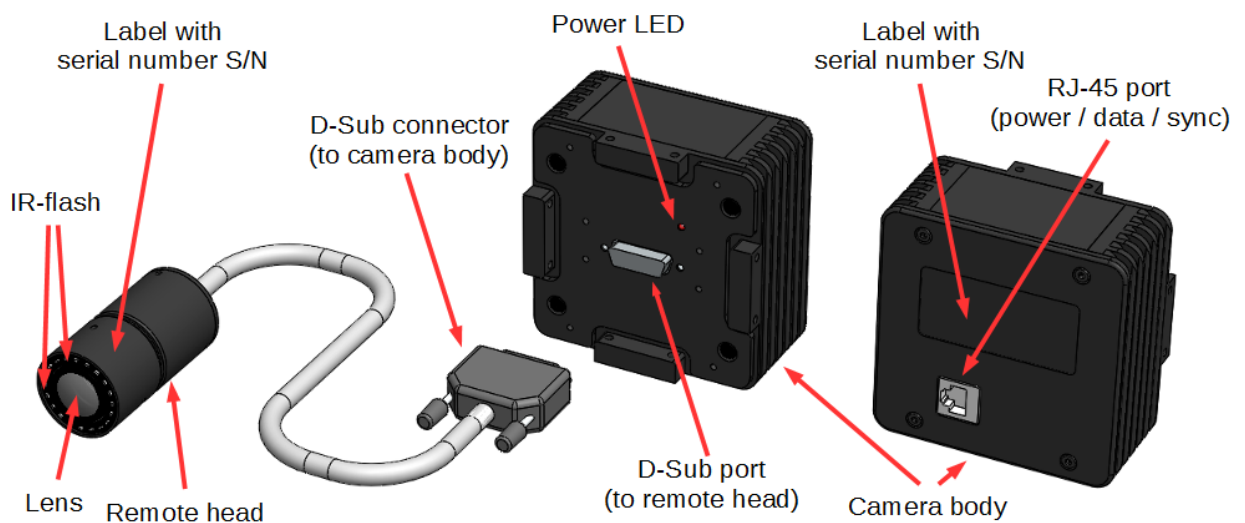

Figure 4.3: Camera *ARTTRACK5/C* - Description of LEDs and interface connectors



The *ARTTRACK5/C* camera may be combined and mixed with the *ARTTRACK5* or *TRACKPACK/E* camera in one tracking system. Alternatively a tracking system may consist of *ARTTRACK5/C* cameras only. Both variants are limited to a total number of 80 cameras per system.



The 26-pin D-Sub connector between *ARTTRACK5/C* remote camera head and camera body employs proprietary design. Do not try to connect the remote head to any other port (e.g. COM port) !!!

4.1.4 TRACKPACK/E



Keep a distance of min. 20 cm when operating the camera ! The camera is assigned to the Exempt Group according to IEC62471-1 and therefore poses no risk or hazard to the human eye or skin at this distance.

Description The *TRACKPACK/E* infrared camera is intended for working environments with distances between camera and markers of up to 4.5 metres (see figure 4.4 on page 28). With its 3.5 mm lens a large field of view (FoV) is covered. Refer to A.1 on page 126 for more information.

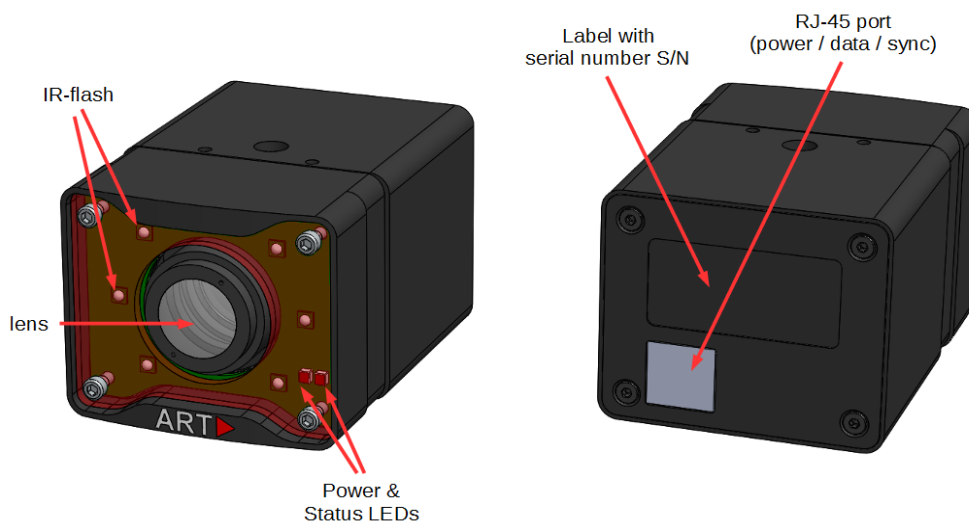

Figure 4.4: Camera *TRACKPACK/E* - Description of LEDs and interface connectors

4.2 Controller

Description All *ART* multi-camera systems are based on a controller which operates cameras, interaction devices (optional) and targets respectively. The backend software runs on the controller - all necessary calculations (3DOF, 6DOF data, etc.) are performed there.

4.2.1 ART Controller

Description The *ART Controller* comes in a 19" inch housing compatible for rack mounting, see fig. 4.5 on page 29.

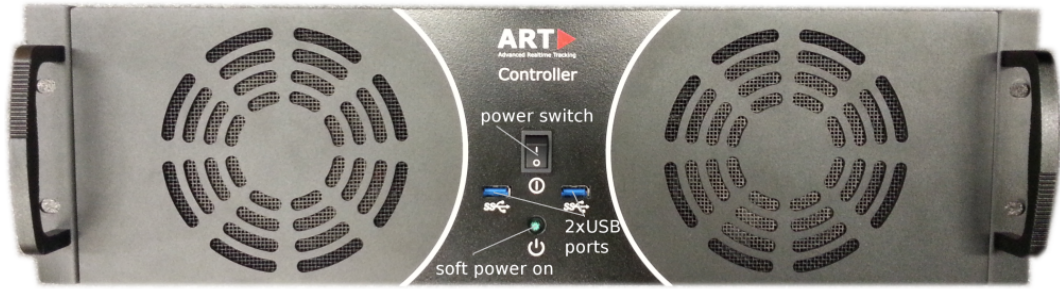

(a) front view

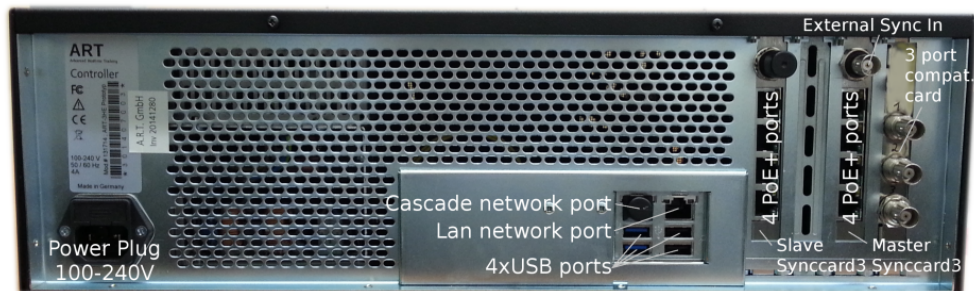

(b) back view

Figure 4.5: *ART Controller*



The ventilation holes of the *ART Controller* must not be covered. Ensure unblocked airflow at all times. The minimum distance between equipment and surrounding objects has to be larger than 3 cm.

4.2.2 *ART Controller/M*

Description The *ART Controller/M* comes in a compact size housing for stand-alone usage, see fig. 4.6 on page 30.

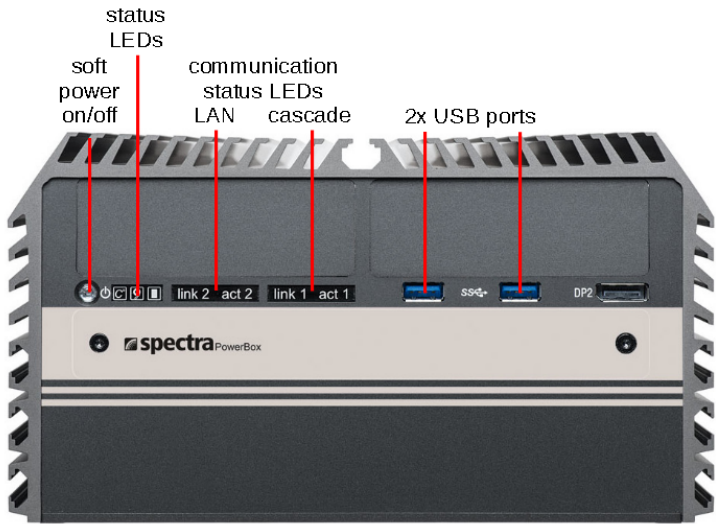

(a) front view

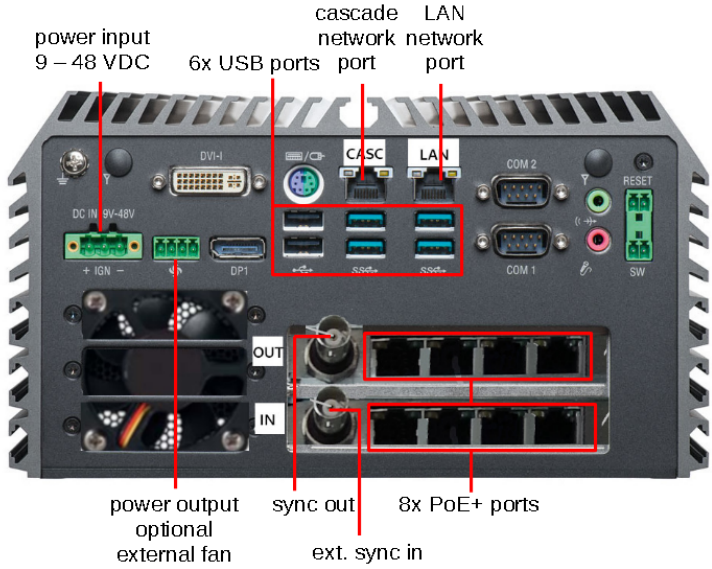

(b) back view

Figure 4.6: ART Controller/M



The ventilation hole on the back of the ART Controller/M must not be covered. Ensure unblocked airflow at all times. The minimum distance between equipment and surrounding objects has to be larger than 3 cm.

4.2.3 Compatibility

	<i>ART Controller</i>	<i>ART Controller/M</i>	<i>ARTTRACK Controller</i>	<i>TRACKPACK Controller</i>	<i>DTRACK3</i>
<i>ARTTRACK1</i>	×	× ¹	×		×
<i>ARTTRACK2</i>	×	× ¹	×		×
<i>ARTTRACK3</i>	×	× ¹	×		×
<i>ARTTRACK5</i>	×	×			×
<i>ARTTRACK5/C</i>	×	×			×
<i>ARTTRACK6/M</i>	×	×			×
<i>TRACKPACK</i>				×	×
<i>TRACKPACK/C</i>				×	×
<i>TRACKPACK/E</i>	×	×			×
<i>Flystick2</i>	×	×	×	×	×
<i>Flystick2+</i>	×	×	×	×	×
<i>Flystick3</i>	×	×	×	×	×
<i>Fingertracking</i> ²	×	×	×	×	×
<i>FINGERTRACKING2</i>	×	×	×	×	×
<i>Tactile</i> ²					
Measurement Tool ³	×	×	×	×	×
Trivisio wireless IMU ³	×	×	×	×	×
Yost Labs wired IMU ³	×	×	×	×	×

¹ only syncgroup #1 available

² for *Fingertracking* it is recommended to use six cameras for ideal operation

³ an appropriate license may be necessary (please refer to the *DTRACK3 User's Guide*)

Table 4.1: Compatibility of *DTRACK3* with *ARTTRACK* cameras, interaction devices and controllers

4.3 Integrated systems

4.3.1 SMARTTRACK3 & SMARTTRACK3/M



Keep a distance of min. 20 cm when operating the SMARTTRACK3 & SMARTTRACK3/M ! The SMARTTRACK3 & SMARTTRACK3/M are assigned to the Exempt Group according to IEC62471-1 and therefore poses no risk or hazard to the human eye or skin at this distance.

Description The *SMARTTRACK3* is a fully integrated stand-alone infrared optical tracking system (see figure 4.7 on page 32). It is designed to be used in small volumes of approx. 2m³.

The *SMARTTRACK3/M* offers a more compact design using otherwise identical hardware (see figure 4.8 on page 32). Thus for sake of readability the following section refers to the *SMARTTRACK3* in general.

Integrated controller The two tracking cameras and controller are integrated in the *SMARTTRACK3* which means that both calculations as well as the generation of the

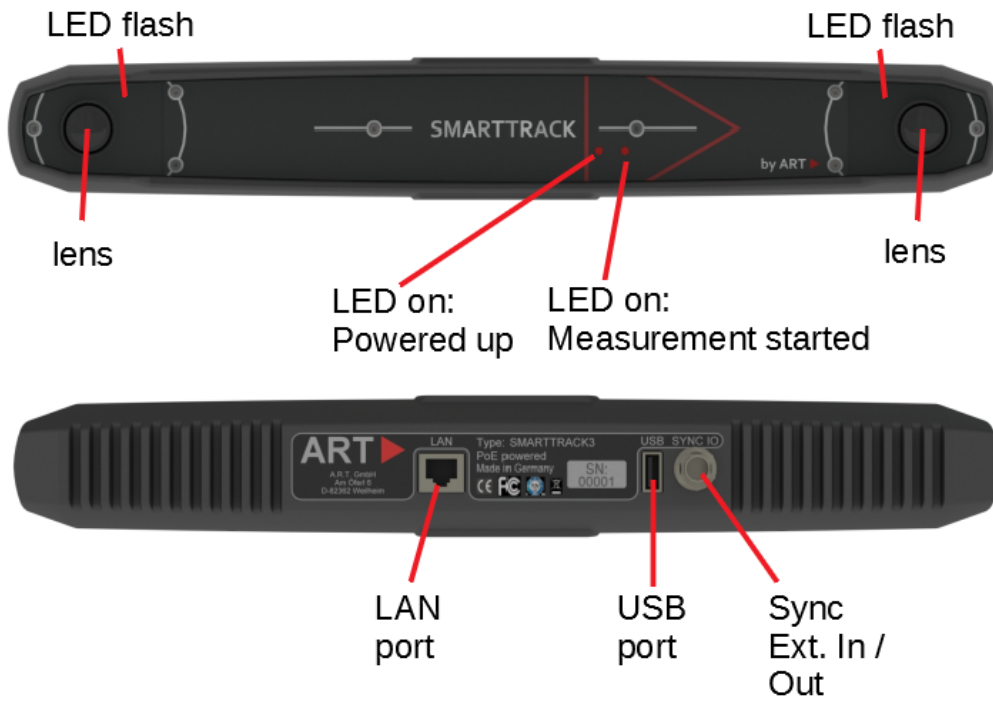

Figure 4.7: **SMARTTRACK3** - Front & Back view

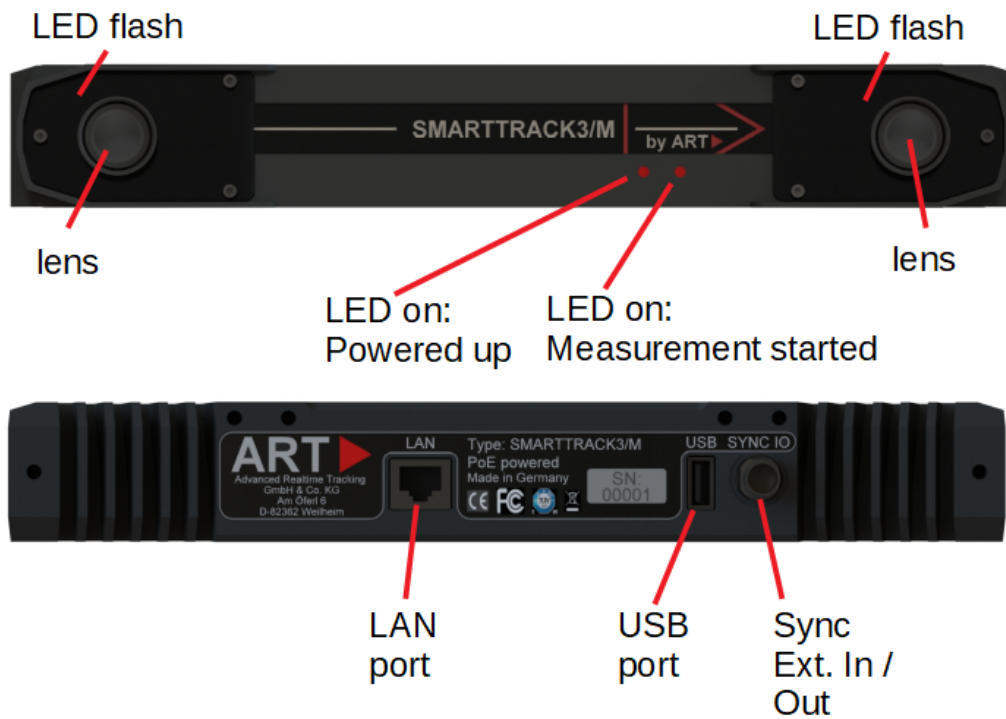

Figure 4.8: **SMARTTRACK3/M** - Front & Back view

data output stream are performed inside the *SMARTTRACK3* housing.

4.4 Other equipment

4.4.1 PoE+ switch for larger systems

Description In larger systems (> 8 *ARTTRACK6/M*, *ARTTRACK5* and *ARTTRACK5/C* cameras **ONLY**), please use compatible switches authorized by *ART* (refer to figure 4.9 on page 33 and table 4.2 on page 33).

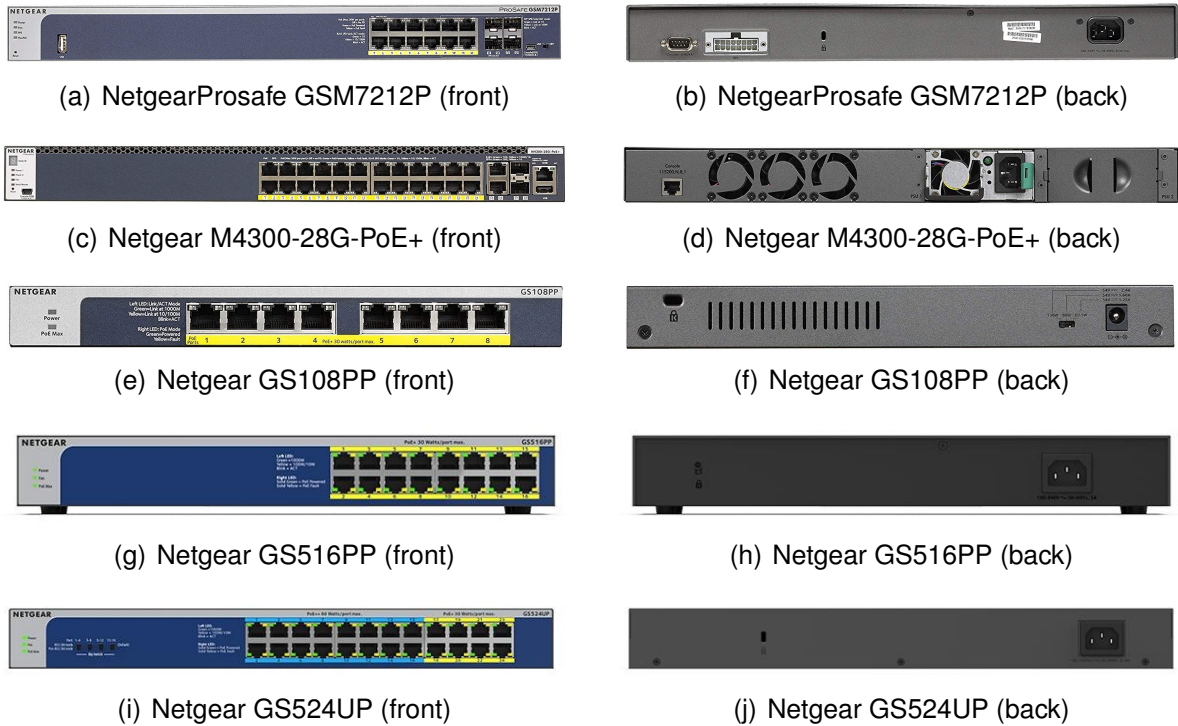

Figure 4.9: View of PoE+ switches authorized by *ART*

Type	ports	Description
Netgear Prosafe GSM7212P PoE+	12	See note [1,2]
Netgear M4300-28G-PoE+	24	See note [1,2]
Netgear GS108PP	8	See note [2]
Netgear GS516PP	16	See note [2]
Netgear GS524UP	24	See note [2]

¹ Please use the accessible ports without protective caps only.

² To turn on the PoE+ switch, please connect it to mains or external power supply respectively.

Table 4.2: Compatible PoE+ switches authorized by *ART*



Please allow min. 3 minutes for booting prior to starting the *ART Controller* and *ART Controller/M* !



Due to non-default settings do not tamper with the configuration of all managed switches authorized by **ART** . Ask your **ART** representative for details when necessary.



Use only original components and accessories from **ART** or authorized by **ART** . Using unauthorized components or accessories may damage the equipment, may cause malfunctioning and may compromise operational safety.



In case connectivity is provided using third party equipment please ensure compliance to all applicable standards regarding connectivity and power supply (see chapter A on page 126). Non-compliance may result in loss of conformity ! All warranty and liability is void.

4.4.2 RadioTransceiver2/3

Description The *RadioTransceiver2/3* are used for radio communication with interaction devices such as *Flystick2/2+/3* or *FINGERTRACKING2 Tactile* . Plug-in the *RadioTransceiver2/3* to any free USB port of the controller, then press *F2* in order to search for new hardware. Configuration is done automatically.

In case you need to change settings manually please refer to the *DTRACK3 User's Guide* .



Figure 4.10: USB Radio Transceiver3 - Description of LEDs

When *DTRACK3* is started, LED (1) (see figure 4.10 on page 34, square frame) turns on and indicates that the radio transceiver was correctly initialized; LED (2) extinguishes.

During measurements, LED (1) is flashing whenever data is received from or transmitted to the *Flystick2/2+/3* . In case of unsuccessful data transmission to the *Flystick2/2+/3* , LED (2) starts flashing.

During boot-up of the controller, LED (2) (see figure 4.10 on page 34, circular frame) is running continuously.



The *SMARTTRACK2* comes with an integrated radio transceiver. Do not plug in an additional *RadioTransceiver2/3*

4.5 Discontinued hardware

4.5.1 ARTTRACK2



Keep a distance of min. 20 cm when operating the camera ! The camera is assigned to the Exempt Group according to IEC62471-1 and therefore poses no risk or hazard to the human eye or skin at this distance.

Description The *ARTTRACK2* infrared camera is intended for working environments with distances between camera and markers of up to 4 metres (see figure 4.11 on page 35). By default the *ARTTRACK2* is equipped with a 3.5 mm lens. Depending on the application and the setup the *ARTTRACK2* can be equipped with other lenses (i.e. with different focal lengths). Refer to A.1 on page 126 for a list of available focal lengths and the respective FoV.

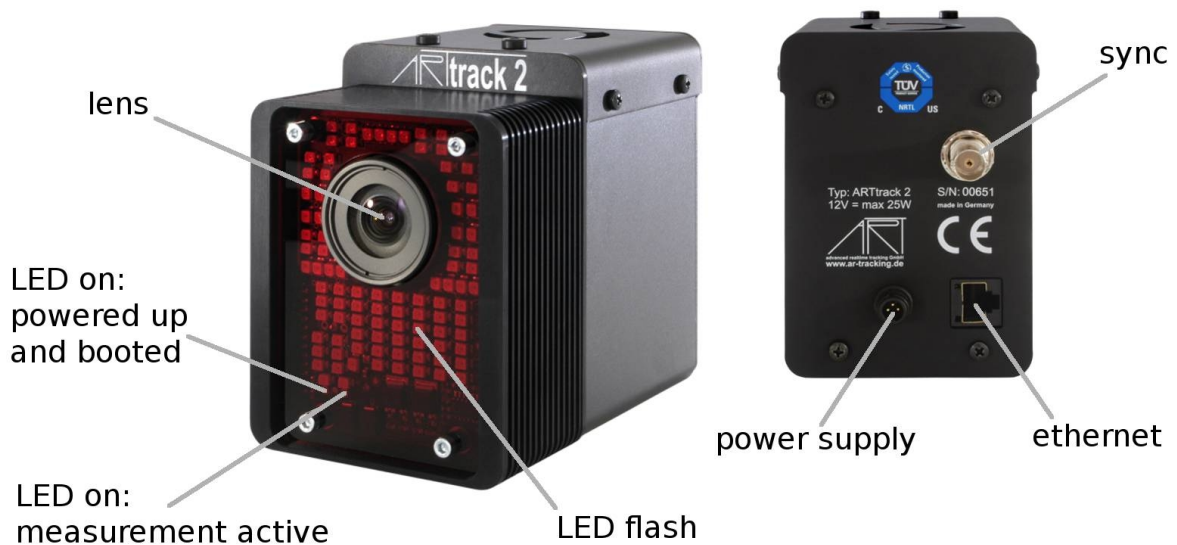

Figure 4.11: Camera *ARTTRACK2* - Description of LEDs and interface connectors

4.5.2 ARTTRACK3



Keep a distance of min. 20 cm when operating the camera ! The camera is assigned to the Exempt Group according to IEC62471-1 and therefore poses no risk or hazard to the human eye or skin at this distance.

Description The *ARTTRACK3* infrared camera is intended for working environments with distances between camera and markers of up to 6 metres due to its large IR flash (see figure 4.12 on page 36). It also features a passive cooling system (i.e. without

fan) which is suitable for noise sensitive environments. By default the **ARTTRACK3** is equipped with a 4.5 mm lens. Depending on the application and the setup the **ARTTRACK3** can be equipped with other lenses (i.e. with different focal lengths). Refer to A.1 on page 126 for a list of available focal lengths and the respective FoV.



Figure 4.12: Camera **ARTTRACK3** - Description of LEDs and interface connectors

4.5.3 TRACKPACK



Keep a distance of min. 20 cm when operating the camera ! The camera is assigned to the Exempt Group according to IEC62471-1 and therefore poses no risk or hazard to the human eye or skin at this distance.

Description The **TRACKPACK** is intended for Head- and Flysticktracking in multi-sided projection environments (max. 3 m x 3 m x 2 m) or in front of medium-sized projection screens (up to 4.5 m wide), see figure 4.13 on page 37. The system either consists of two or four **TRACKPACK** cameras and a **TRACKPACK** Controller.

By default the **TRACKPACK** is equipped with a 3.5 mm lens. Depending on the application and the setup the **TRACKPACK** camera can be equipped with other lenses (i.e. with different focal lengths). Refer to A.1 on page 126 for a list of available focal lengths and the respective FoV.



The RJ45 connection between **TRACKPACK camera and controller is used for power supply and synchronization signal. It is not a standard Ethernet connection! That is why connecting the RJ45 connector to any other than the equivalent port of the controller may damage the camera or the connected partner.**



Figure 4.13: Camera *TRACKPACK* - Description of LEDs and interface connectors

4.5.4 *TRACKPACK/C*



Keep a distance of min. 20 cm when operating the camera ! The camera is assigned to the Exempt Group according to IEC62471-1 and therefore poses no risk or hazard to the human eye or skin at this distance.

Description The *TRACKPACK/C* camera is designed for tracking in multi-sided projection environments (e.g. CAVE®, I-Space). In such an environment it is necessary to drill holes into the projections' corners. The *TRACKPACK/C* camera has been designed to easily fit into such holes by separating the lens from the electronics part (see figure 4.14 on page 38). With its 3.5 mm lens a large field of view (FoV) is covered. Refer to A.1 on page 126 for the respective FoV.



The *TRACKPACK/C* camera may be combined and mixed with the *TRACKPACK* camera in one tracking system. Alternatively a tracking system may consist of *TRACKPACK/C* cameras only. Both variants are limited to a total number of four cameras per system and come with a *TRACKPACK* Controller.



The RJ45 connection between *TRACKPACK/C* camera and controller is used for power supply and synchronization signal. It is not a standard Ethernet connection! That is why connecting the RJ45 connector to any other than the equivalent port of the controller may damage the camera or the connected partner.

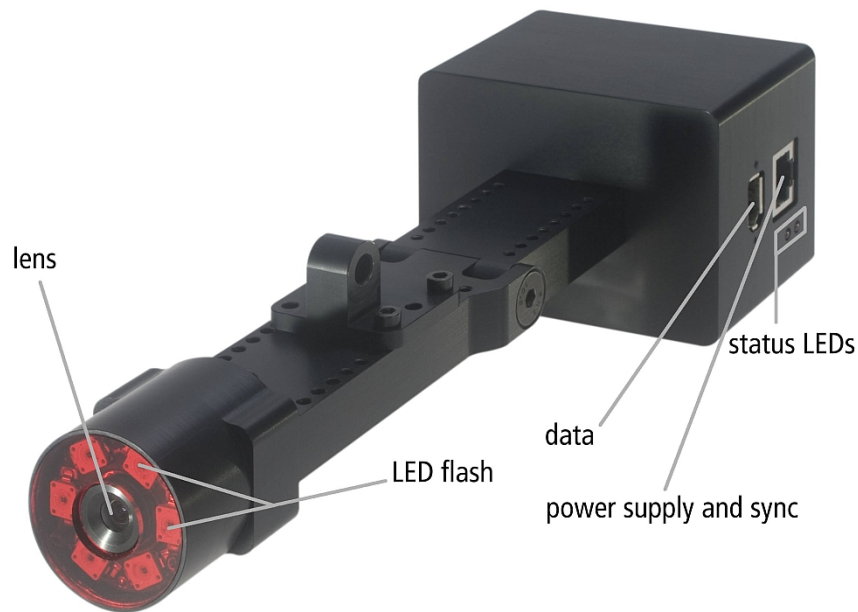

Figure 4.14: Camera *TRACKPACK/C* - Description of LEDs and interface connectors

4.5.5 *SMARTTRACK2*



**Keep a distance of min. 20 cm when operating the *SMARTTRACK2* !
The *SMARTTRACK2* is assigned to the Exempt Group according to IEC62471-1 and therefore poses no risk or hazard to the human eye or skin at this distance.**

Description The *SMARTTRACK2* is a fully integrated stand-alone infrared optical tracking system (see figure 4.15 on page 39). It is designed to be used in small volumes of approx. 2m³. The typical tracking volume of the *SMARTTRACK2* is illustrated in figure 4.16 on page 39.

4 Hardware Components

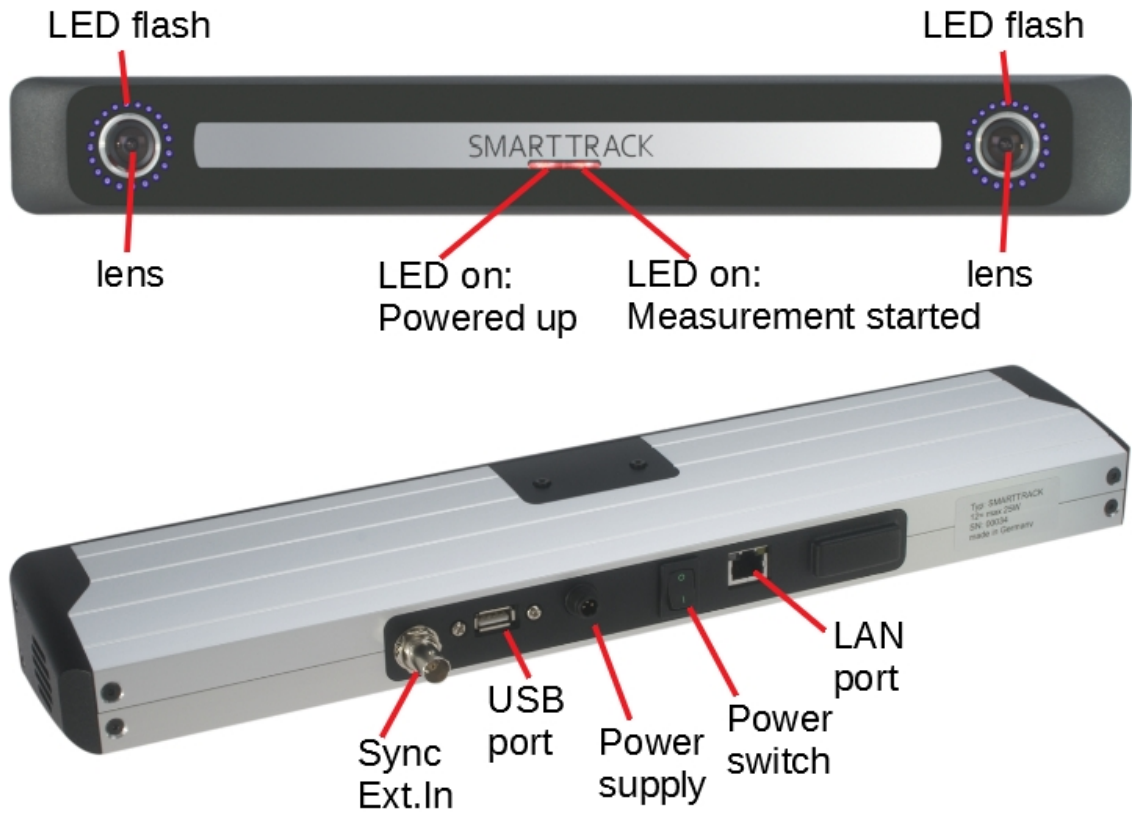

Figure 4.15: **SMARTTRACK2** - Front & Back view

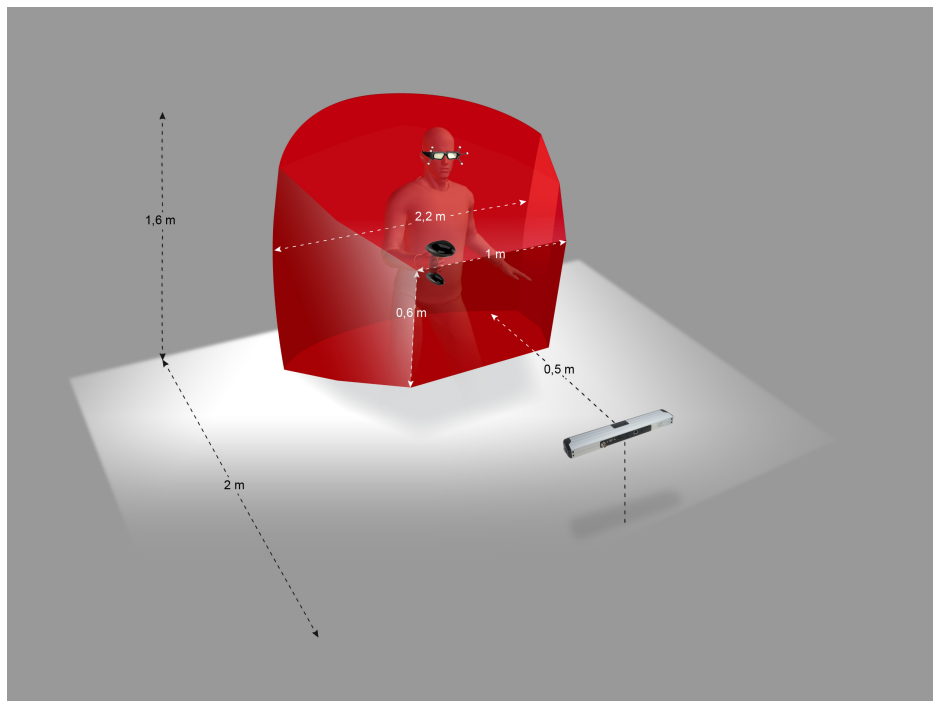

Figure 4.16: 3D Visualization of the tracking volume

5 System setup

5.1 Setting up the cameras

5.1.1 Camera orientation

While mounting the cameras or *SMARTTRACK2/3/M* it is vital to adjust the orientation of each camera and the *SMARTTRACK2/3/M* respectively such that the measurement volume is covered completely by the field of view (FoV) of all cameras.

On the one hand camera mounting has to ensure that tracking is possible over the entire measurement volume. On the other hand attention has to be paid to the fact that the calibration angle (for room calibration) can be seen completely by at least two cameras or the *SMARTTRACK2/3/M*. When using multi-camera setups, the FoV of all cameras has to overlap sufficiently to enable the calculation of the photogrammetric orientation of all cameras in a common coordinate system, especially if the calibration angle can not be seen by each camera.

Furthermore it is important to remove disturbing reflections (refer to 5.1.2 on page 40) from the FoV of cameras and *SMARTTRACK2/3/M* respectively. Additionally this step is important to minimize mutual blinding of the cameras, i.e. the IR flash of one camera is inside the FoV of another (refer to 5.1.3 on page 41).

Therefore, as part of its GUI *DTRACK3* provides the *Monitor 2DOF display* which is a 2-dimensional graphical display or monitor for each camera equivalent to its field of view. At this point, you will probably find it most useful to become acquainted with the graphical user interface and the main window of *DTRACK3*. Please refer to the *DTRACK3 User's Guide* for detailed information.

5.1.2 Localizing and removing of disturbing reflections

Possible sources of disturbing reflections may be diverse. Still all of them may be detected when starting the *Monitor 2DOF display* in *DTRACK3*. They are illustrated the same way as markers, i.e. with small coloured crosses or circles, depending on the distance to the camera or *SMARTTRACK2/3/M* (see figure 5.1 on page 41).

Typically the reflections arise from one (or more) of the following points:

- active or passive targets that are inside the FoV / tracking range of the cameras,
- strong IR sources (e.g. sunlight or sunrays, halogen lamps, ...),

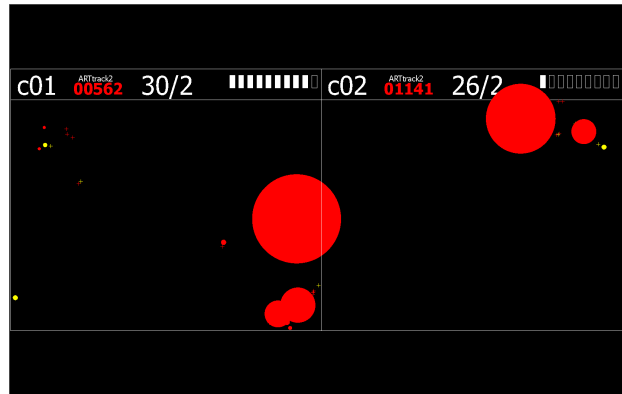

Figure 5.1: Typical situation arising from reflections through sunlight

- mutual blinding of opposing or adjacent cameras
- any kind of reflective material on clothes or shoes (e.g. reflective tape on safety vests),
- blank metal surfaces that act as mirrors, especially curved surfaces and polished surfaces with 90° angles,
- some types of packaging foils.

For localising and removing disturbing reflections follow this simple approach:

- active targets or IR sources: reduce the flash intensity of all cameras to '0'
Try to localize and remove the remaining markers / reflections which originate from infrared radiation sources (e.g. sunlight, halogen lamps, ...).
- mutual blinding: reduce the flash intensity of all cameras to '0', then set each camera's flash intensity to full one after the other
Corresponding / opposing cameras can be easily identified. Re-mount the relevant cameras until *Monitor 2DOF display* does not show markers and the LED bar does not indicate levels of intensity. You may also assign different syncgroups at this stage. Please refer to chapter **DTRACK3 User's Guide** → *Hardware Configuration* → *Cameras* for further information.
- other non-specific reflections: set the flash intensity of all cameras to '50'
Try to localize the reflection by moving a target or reflective marker towards the origin of the reflection (use the *Monitor 2DOF display*) and remove it.

5.1.3 Mutual blinding

Another possible source of disturbing reflections is mutual blinding of adjacent or opposing cameras that are inside the FoV of each other. This can be well observed in the *Monitor 2DOF display* as the cameras falsely identify the IR flashes as numerous flickering markers (i.e. clusters of crosses or circles). Tracking will be severely affected in the involved areas of the measurement volume / FoV. The intensity of the simulated LED bar

next to the number of markers seen / used for tracking may serve as another indicator. In order to distinguish from targets or other reflections please remove all reflective markers from the measurement volume in the first step. Then check whether the *Monitor 2DOF display* still shows the presence of markers and whether the LED bar shows high levels of intensity. Try to re-arrange or re-adjust the cameras (i.e. position and orientation).

Rarely there may also be mutual blinding that is not fully illustrated in the *Monitor 2DOF display*. Then only the simulated LED bar will indicate high levels of intensity whereas the presence of markers is missing (see figure 5.2 on page 42).

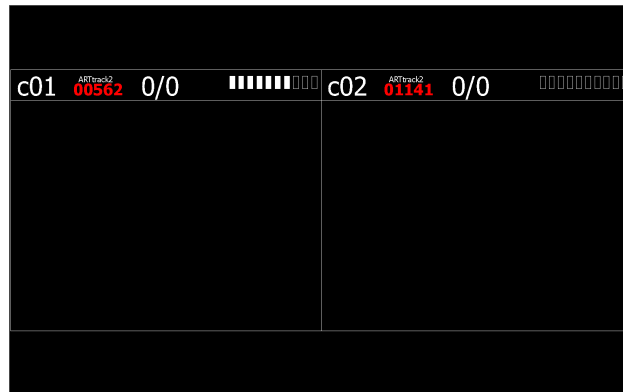

Figure 5.2: Mutual blinding without reflex illustration

5.1.3.1 Assigning syncgroups (available for *ART Cameras* and *SMARTTRACK3 & SMARTTRACK3/M cascades* only)

If reorienting the cameras seems not feasible, the cameras can also be assigned to different syncgroups, i.e. setting individual time delays for each camera in order to shift the IR flash / measurement of one camera in time from the measurement recording of another camera. In other words, a short time delay (typically < 1ms) is introduced between the measurements of two cameras which are assigned to different syncgroups. Thus the IR flash of one camera cannot be detected by the other and vice versa.

Recommendation Assign opposing or adjacent cameras within the FoV of each other to different syncgroups (e.g. 'Channel 1' and 'Channel 2'). Cameras, that are outside of the FoV of each other (e.g. mounted on the same wall) should be assigned to the same syncgroup. For *ARTTRACK6/M*, *ARTTRACK5*, *ARTTRACK5/C* and *TRACK-PACK/E* systems it is possible to configure the syncgroups via software. Please refer to the *DTRACK3 User's Guide* → *Hardware* → *Cameras* for further information. For *ARTTRACK2*, *ARTTRACK3* (discontinued) please refer to chapter 5.2 on page 52 for installation instructions.

5.1.4 Static reflex suppression

If, by any means, reflections cannot be eliminated completely you may use the static reflex suppression of **DTRACK3**, i.e. blocking individual areas of the FoV / measurement volume to eliminate mutual blinding. **DTRACK3**, all **ART** cameras and **SMARTTRACK2/3/M** are able to suppress all reflections in defined areas of the image sensor. Scanning for static reflections allows searching the measurement FoV for unwanted reflections. Areas are defined on top of the visible reflections, where all data on the image sensor is neglected during measurements. This is especially important for setups in multi-sided projections or in the corner of a room where the cameras may suffer from unwanted reflections from the nearby walls. For good tracking results these reflections should be suppressed. Be aware that the FoV / effective measurement volume will be decreased, which is why reflex suppression should always be the last option to be considered. If possible, try re-orienting the cameras in order to minimize reflections. Please refer to the **DTRACK3 User's Guide** for further details.



Be aware that reflex suppression leads to decreased FoV / effective measurement volume by blocking the area in which the reflection originated.

5.1.5 Room Calibration - Overview

5.1.5.1 Room calibration - integrated systems

The **SMARTTRACK2/3/M** are pre-calibrated, you can start tracking without performing a room calibration. By default, the origin of the coordinate system lies approximately in the center between the two cameras. The orientation of the coordinate system is as shown in figure 5.3 on page 44.

This default orientation and position is called 'Middle of cameras'. If this is not adequate for your application, you may perform a new room calibration with the **SMARTTRACK2/3/M**. Please refer to chapter 5.1.5.2 on page 43 for further information.



It is recommended to perform a room (re-)calibration on a regular basis (e.g. after a certain operating time of the system) and especially if the system was subject to extreme vibrations or changing environmental conditions (e.g. high or low temperatures).



Example: If the SMARTTRACK2/3/M is rotated by one tenth of a degree it will cause aberrations of the optical rays that are as high as 5 millimetres in 2 metres distance from the SMARTTRACK2/3/M. This will result in shifts of the room coordinate system.

5.1.5.2 Room calibration - multi-camera setups

Before you can start tracking, a so called room calibration has to be carried out. During this calibration, the system identifies the position of the cameras inside the measurement volume and determines the three-dimensional coordinate system. Carrying out a room

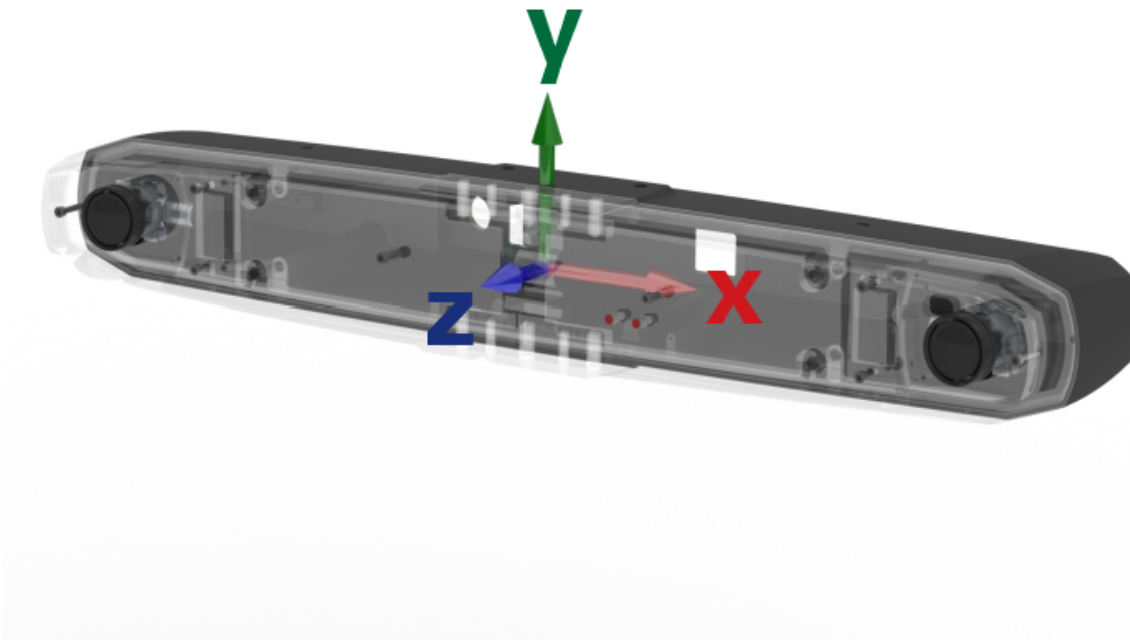

Figure 5.3: Origin of the room coordinate system (default)

calibration is always the first step. Without it, body calibration and tracking will not be possible.



Example: If a camera with 3.5mm lenses (standard for *ARTTRACK5* or *TRACKPACK/E*) is rotated by one tenth of a degree it will cause aberrations of the optical rays that are as high as 5 millimetres in 3 metres distance from the camera. This will result in unacceptable errors in the measurement results, hence, *DTRACK3* will exclude data from such a camera and it will not contribute to tracking.

In summary room calibration has to be carried out

- after the first system setup,
- when the default orientation and position of the *SMARTTRACK2/3/M* coordinate system is not adequate for your application
- after any changes of IR camera positions (→ Room re-calibration),
- after any changes to the number of cameras,
- before a body calibration (when system has been setup initially),
- whenever any uncertainty regarding the mechanical stability or the environmental conditions of the setup occurs.

5.1.5.3 Room calibration hardware

To perform a room calibration two pieces of hardware are needed, the '*calibration angle*' (see figure 5.4 on page 45) of the "room calibration set" and the '*wand*'. The position and orientation of the '*calibration angle*' defines the origin and axes of the room coordinate system.

The pre-calibrated rod carrying two markers is called the '*wand*'. Its function is to create a virtual "point cloud" in the measurement volume that is used for calculating the relative positions of the IR cameras with high accuracy. Furthermore the '*wand*' is used for scaling the system. Therefore damaging the wand (loose markers, bent rods, etc.) leads to miscalculations of the scale and the measurement volume.



Figure 5.4: A room calibration set consisting of angle and wand

5.1.5.4 Room calibration process

The first step to perform a room calibration is to place the '*calibration angle*' inside the tracking volume (i.e. into the FoV of the IR cameras or **SMARTTRACK2/3/M**), see figure 5.5 on page 46. At least two IR cameras (i.e. both cameras of the **SMARTTRACK2/3/M**) have to see all markers of the '*calibration angle*'. The two markers of the '*wand*' should be visible to all IR cameras.

Now move the '*wand*' gently in all possible directions (up/down, left/right, back/forth) and additionally rotate it within the measurement volume (also refer to figure 4.16 on page 39) in order to generate a virtual point cloud. If possible, try to walk around to maximize the point cloud in all dimensions (see figure 5.5 on page 46).

The point cloud is used for calculation of IR cameras positions, so moving the '*wand*' in only a very small part of volume will result in reduced accuracy of calibration. Also avoid quick and jerky movements.

Please refer to the **DTRACK3 User's Guide** → *Tracking* → *Room* for further details of the procedure.

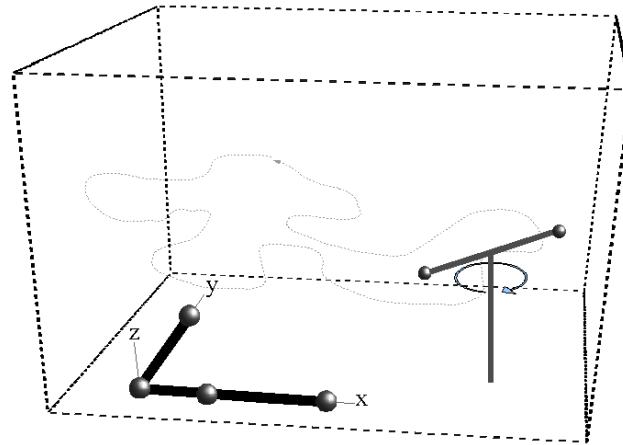

Figure 5.5: Room calibration process

If in a system setup no sufficient part of the measurement volume is seen by all IR cameras simultaneously, the point cloud created by the 'wand' movement has to connect all cameras in a way that ensures the arrangement of all cameras in a common room coordinate system.

Example : A pair of cameras is connected via a shared point cloud as long as both cameras can detect the markers of the 'wand' for a sufficient time. Additional cameras can be connected if they form a suitable pair with the original ones. This way the calibration is stepping forward from camera to camera.



The point cloud should fill at least two thirds of the measurement volume. Moving the wand in a restricted volume will result in reduced accuracy of calibration or failure.

5.1.6 Mounting the cameras

5.1.6.1 General requirements

The cameras are optimized for a predefined range of measurement volumes. System operation in significantly smaller or larger measurement volumes can lead to reduced accuracy. The measurement volume can be adjusted within certain limits simply by changing the flash intensity of the **ART** infrared cameras (see *DTRACK3 User's Guide* → *Hardware* → *Cameras*).

Major changes of the measurement volume may require different lenses and thus a new determination of camera parameters. Please contact your **ART** representative.



The flash intensities should not be too high. In general, a flash intensity of 50-60 (3-4 for ARTTRACK2 ,ARTTRACK3 ,TRACKPACK or SMARTTRACK2) might be sufficient.



To further avoid problems no light sources or highly reflecting areas should be visible to the camera. Especially strong point light sources like e.g. halogen lamps and direct or reflected sunlight may imply problems for the measurement (fluorescent lamps are ok).



Make sure to install the system in a way that you can easily access the cameras and its cables.



Do not touch the front pane of the cameras. The acrylic pane and the lens have highly sensitive surfaces. Be careful to avoid permanent damages (e.g. scratches). Grab the cameras only on the housing.



Shock and severe vibrations can permanently damage the internal calibration of the cameras. De-calibrated cameras have to be sent in for maintenance.



The power cord and plug should be accessible freely. The power socket should be close to the equipment.



Do not drop the equipment.



Never unfasten screws that are not designed for mounting. All liability and warranty is void.



Use only accessories for mounting (screws, ceiling suspension) supplied by **ART**. Do not forget the toothed washer !



The ventilation holes of the equipment (particularly of **SMARTTRACK2**, **ARTTRACK2**, **ART Controller** and **ART Controller/M**) must not be covered. Ensure unblocked airflow at all times. The minimum distance between equipment and surrounding objects has to be larger than 3 cm.

5.1.6.2 Tripod mounting

Most **ART** cameras and the **SMARTTRACK3** & **SMARTTRACK3/M** are equipped with UNC 1/4" threads on both sides and thus can be mounted to tripod heads directly. For **SMARTTRACK2** (optionally **SMARTTRACK3** & **SMARTTRACK3/M**) and all other cameras just mount the T-piece (UNC 1/4" thread integrated) on the bottom of the camera (see figure 5.6 on page 48).



Mounting on tripods may be sufficient for presentations and preliminary installations, but is not suitable as a permanent solution!

5.1.6.3 Wall mounting

Be aware that a tracking system is very sensitive to camera movements. Therefore the cameras have to be mounted in a way that camera movements (especially vibrations) are reduced as much as possible.

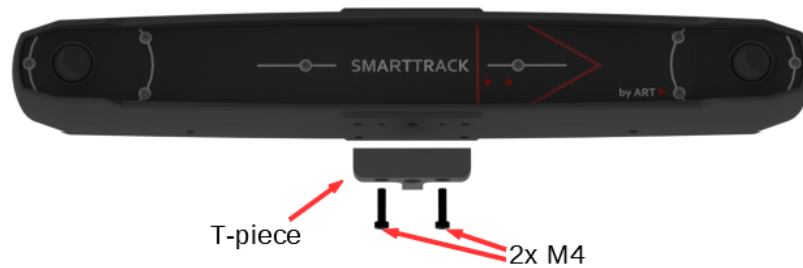

Figure 5.6: Attaching the T-Piece to the *SMARTTRACK2/3/M*

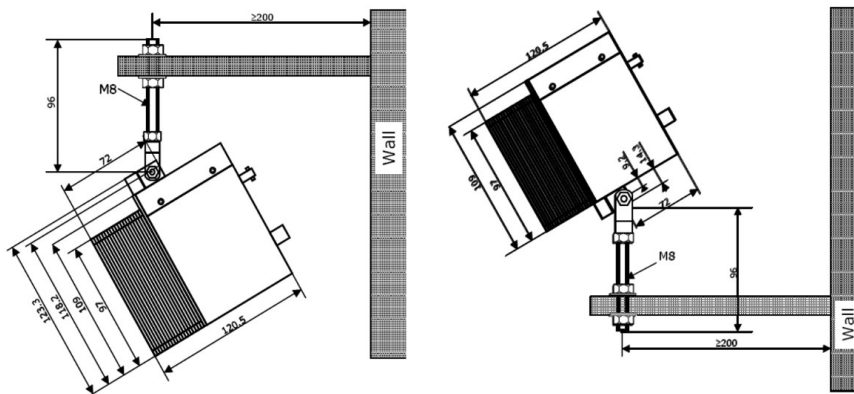

Figure 5.7: Mounting a camera to a wall or a ceiling (e.g. *ARTTRACK2* camera)

Feel free to contact **ART** in case you want to realise a complex installation. We will assist you in your planning.

Figure 5.7 on page 48 shows the correct mounting for a camera to a wall with a ceiling suspension using the example of an *ARTTRACK2* camera. Make sure to keep a distance to the wall so enough room is left for the cables and to allow re-adjustment of the camera angles and in case for maintenance purpose. For easy adjustment it is highly recommended to attach the ceiling suspension in a way that the threaded bolt is vertical. This way heading and elevation of the camera view can be adjusted individually.

If in doubt, ask a skilled craftsman for assistance. Use massive and long enough angle irons to provide the required stiffness and stability.



Be sure that the cameras are firmly mounted using strong wall plugs / anchors and screws when mounting to walls or ceilings. Loosely mounted cameras may pose a serious hazard to health and safety.

5.1.6.4 Mounting the *ARTTRACK6/M*

The ceiling suspension can be attached on two sides of the camera. Attach the carrier with the T-piece to the camera as shown in figure 5.8 on page 49. For more flexibility, the T-piece can be mounted pointing forward or backward. Note, the threaded bolt is already connected to the carrier in figure 5.8.

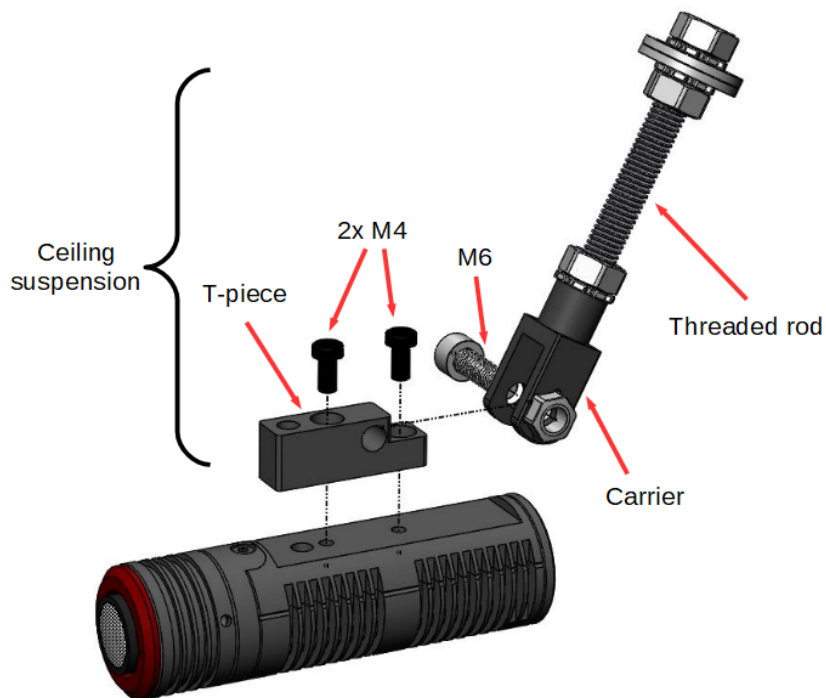

Figure 5.8: Attaching the ceiling suspension to the **ARTTRACK6/M** camera

5.1.6.5 Mounting the **ARTTRACK5**

The ceiling suspension can be attached on both bottom and top side of the camera. Attach the carrier with the T-piece to the camera as shown in figure 5.9 on page 50. For more flexibility, the T-piece can be mounted pointing forward or backward. Note, the threaded bolt is already connected to the carrier in figure 5.9.

5.1.6.6 Mounting the **ARTTRACK5/C**

The ceiling suspension can be attached on all 4 sides of the camera body. Attach the carrier with the T-piece pointing to the back of the camera body in a similar way to figure 5.9 on page 50. Note, the threaded rod is already connected to the carrier in figure 5.9. The **ARTTRACK5/C** remote camera head should be installed using the M6 mounting threads on its back as shown in figure 5.10 on page 50.



If you would like to mount an **ARTTRACK5/C camera on a tripod just mount the T-piece on any side of the camera body and then the remote camera head on the opposite side using a ceiling suspension.**



Do not use standard screws for connection of the remote camera head due to limited space between thread and cable.

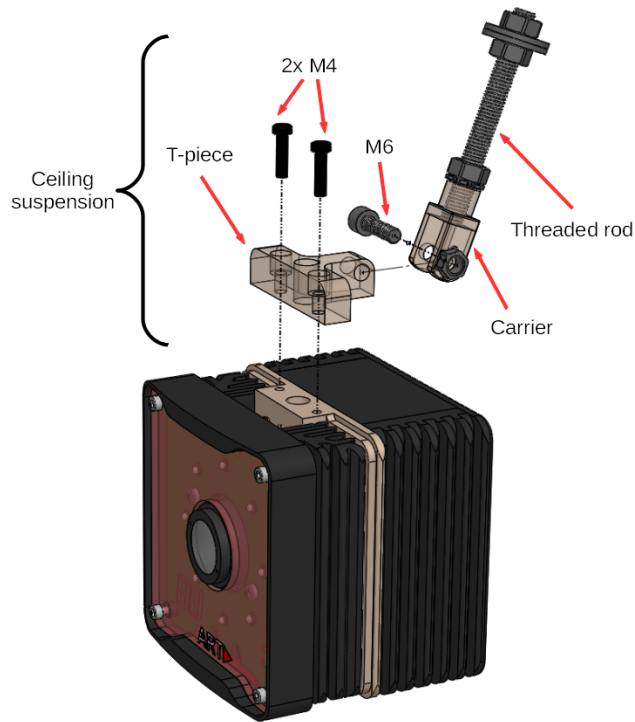

Figure 5.9: Attaching the ceiling suspension to the *ARTTRACK5* camera

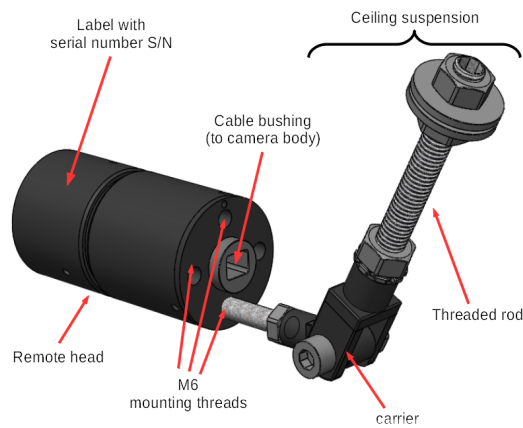

Figure 5.10: Camera *ARTTRACK5/C* remote head (back)



The *ARTTRACK5/C* remote head has to be connected to its corresponding camera body. During mounting please ensure matching serial numbers for both parts !

5 System setup

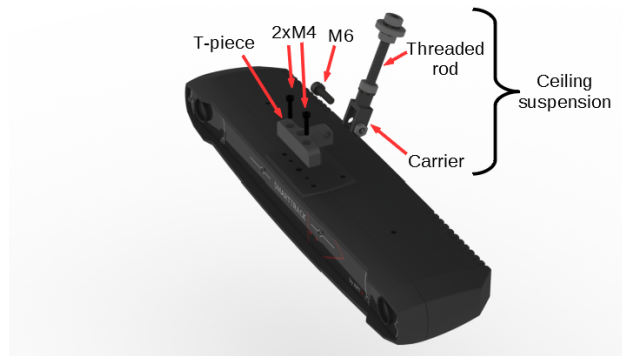

Figure 5.11: Attaching the Ceiling Suspension to the **SMARTTRACK3**

5.1.6.7 Mounting the **TRACKPACK/E**

The ceiling suspension can be attached to the **TRACKPACK/E** on both bottom and top side of the camera. Attach the carrier with the T-piece to the camera in a similar way to figure 5.9 on page 50. For more flexibility, the T-piece can be mounted pointing forward or backward. Note, the threaded rod is already connected to the carrier in figure 5.9.

5.1.6.8 Mounting the **SMARTTRACK3 & SMARTTRACK3/M**

The ceiling suspension can be attached to the **SMARTTRACK3 & SMARTTRACK3/M** on both bottom and top side of the housing. Attach the carrier with the T-piece pointing to the back of the **SMARTTRACK3 & SMARTTRACK3/M** as seen in figure 5.11 on page 51).

5.1.7 Installation of cables

Please install the cables

- trip-proof so no one can trip over the cords,
- so the cords cannot be damaged,
- so the cords cannot damage the equipment due to mechanical strain,
- so the line of sight of the cameras (internal in **SMARTTRACK2/3/M**) is not obstructed.

Connecting the cameras For connecting the cables to the controllers please refer to the respective chapters:

- **ART Controller** : 5.2.1 on page 52
- **ART Controller/M** : 5.2.3 on page 55
- **SMARTTRACK3 & SMARTTRACK3/M** :5.3 on page 60

- **ARTTRACK** Controller (discontinued): 5.2 on page 52
- **SMARTTRACK2** (discontinued): 5.9.4 on page 104
- **TRACKPACK** Controller (discontinued): 5.9.3 on page 103



The power cord and plug should be accessible freely. The power socket should be close to the equipment.



Install the cables that the line of sight of the cameras or the **SMART-TRACK2/3/M** is not obstructed.



Install a strain relief to all cables to avoid damage to the equipment.



Install the cables trip-proof (e.g. cable ducts or fixings). Inappropriate cabling may pose a serious hazard to health and safety.

5.2 Installation of the Controller

5.2.1 Installation of the *ART Controller*



Figure 5.12: *ART Controller* front view

To turn on the *ART Controller* flip the power switch to 'I' (see figure 5.12 on page 52). For restart from standby mode press the button 'soft power on'.

The LEDs on the front indicate the status of the *ART Controller* :

- 'Power LED / Soft Power On' (ON: Green, OFF: None)

The following ports on the front of the *ART Controller* are accessible:

- 'USB port':
Please plug in all USB based peripheral devices here (e.g. *RadioTransceiver2/3* for communication with *Flystick2/2+/3* (refer to chapter 4.4.2 on page 34), Trivisio wireless transceivers and Yost Labs wired inertial sensors (refer to *DTRACK3 User's*

5 System setup

Guide → *Hardware* → *Inertial Sensors*). You can also plug-in a USB pen drive for accessing the **ART Controller** without the **DTRACK3** frontend (refer to **DTRACK3 User's Guide** → *Connecting to the controller*).



The ventilation holes of the ART Controller must not be covered. Ensure unblocked airflow at all times. The minimum distance between equipment and surrounding objects has to be larger than 3 cm.

5.2.2 Ports & Plugs on the ART Controller

The following list gives a short overview of all ports accessible to the user (see figure 5.13 on page 53):



Figure 5.13: **ART Controller** back view

- **ART Synccard3** (master & slave PCI cards) :
 - 'PoE+ ports':

All **ARTTRACK** as well as **TRACKPACK/E** cameras have to be plugged in here. In larger systems (> 8 **ARTTRACK6/M**, **ARTTRACK5** and **ARTTRACK5/C** cameras only) connect the external PoE+ switch to any of these ports.
 - 'OUT1-3' (optional):

These ports are used as synchronization outputs (video signal) and are characterized by their respective time delay related to syncgroup #1 on 'OUT1'. For backwards compatibility connect **ARTTRACK1** – **ARTTRACK3** cameras here. Please refer to chapter 5.2.5.2 on page 60 for more detailed information.

 - * 'OUT1':

Defines syncgroup #1. When using **ARTTRACK1** – **ARTTRACK3** cameras at least one camera has to be connected here if you are using active targets (e.g. **Fingertracking**, **Flystick3**). Refer to chapter 5.8.3 on page 92 for more information.
 - * 'OUT2':

Defines syncgroup #2. The default time delay related to syncgroup #1 is 480 μ s.

* 'OUT3':

Defines syncgroup #3. The default time delay related to syncgroup #1 is 960 μ s.

For cascaded systems please connect 'OUT1' to 'ExtIn' of a slave controller (see chapter 5.6 on page 66).

- **ART Synccard3** (master PCI card **ONLY**):

- 'ExtIn':

Please plug in the external source (TTL or video signal or master controller of a cascaded system) for synchronization here. Please use the accessible port without protective cap only. For configuration refer to chapter 5.5 on page 65. In cascaded systems please connect the external source to the master controller only.

- 'USB port':

Please plug in all USB based peripheral devices here (e.g. *RadioTransceiver2/3* for communication with *Flystick2/2+/3* (refer to chapter 4.4.2 on page 34), Trivisio wireless transceivers and Yost Labs wired inertial sensors (refer to *DTRACK3 User's Guide* → *Hardware* → *Inertial Sensors*) You can also plug-in a USB pen drive for accessing the **ART Controller** without the *DTRACK3* frontend (refer to *DTRACK3 User's Guide* → *Connecting to the controller*).

- 'LAN network port':

Please connect the **ART Controller** to your local network using a twisted pair Cat 5 cable.

- 'Cascaded network port':

For cascaded systems please connect a slave controller to the **ART Controller** (master). Please refer to chapter 5.6 on page 66 for more detailed information.

- 'Power inlet':

Please connect to mains, refer to chapter A.2 on page 130 for detailed information regarding technical specifications.



The power inlet is fuse-protected (2x4A, anti-surge type T) and features a line filter for EMV protection.



In order to replace mains fuses (e.g. ART Controller) always unplug the power cord first. Risk of electric shock !



There are two mains fuses since two power supplies are installed. So the device is possibly still live although only one fuse has blown.

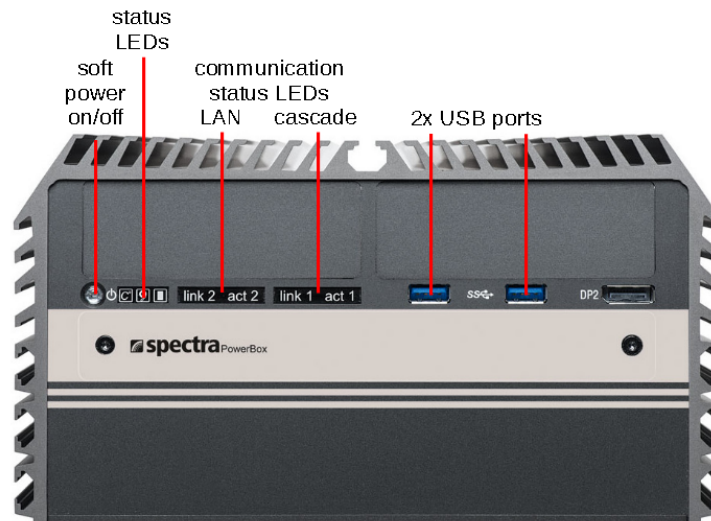

Figure 5.14: *ART Controller/M* front view

5.2.3 Installation of the *ART Controller/M*

The *ART Controller/M* is powered via an external power supply, there is no power switch. To turn on the *ART Controller/M* press the button 'soft power on' (see figure 5.14 on page 55). For restart from standby mode also press the button 'soft power on'.

The LEDs on the front indicate the status of the *ART Controller/M* :

- 'Power LED / Soft Power On' (ON: Green, OFF: Blue)
- 'Temperature LED' (Over Temperature)
- 'Harddisk LED' (Reading / Writing)
- 'Digital I/O' (Working status of digital input / output)
- 'Ethernet LED' (Communication status link: connection, act: data transfer)

The following ports on the front of the *ART Controller/M* are accessible:

- 'USB port':
Please plug in all USB based peripheral devices here (e.g. *RadioTransceiver2/3* for communication with *Flystick2/2+/3* (refer to chapter 4.4.2 on page 34), Trivisio wireless transceivers and Yost Labs wired inertial sensors (refer to *DTRACK3 User's Guide* → *Hardware* → *Inertial Sensors*). You can also plug-in a USB pen drive for accessing the *ART Controller/M* without the *DTRACK3* frontend (refer to *DTRACK3 User's Guide* → *Connecting to the controller*).
- 'Display port':
This port is unused and provides no functionality to the user. Please do not connect any devices.

5.2.4 Ports & Plugs on the ART Controller/M

The following list gives a short overview of all ports accessible to the user (see figure 5.15 on page 56):

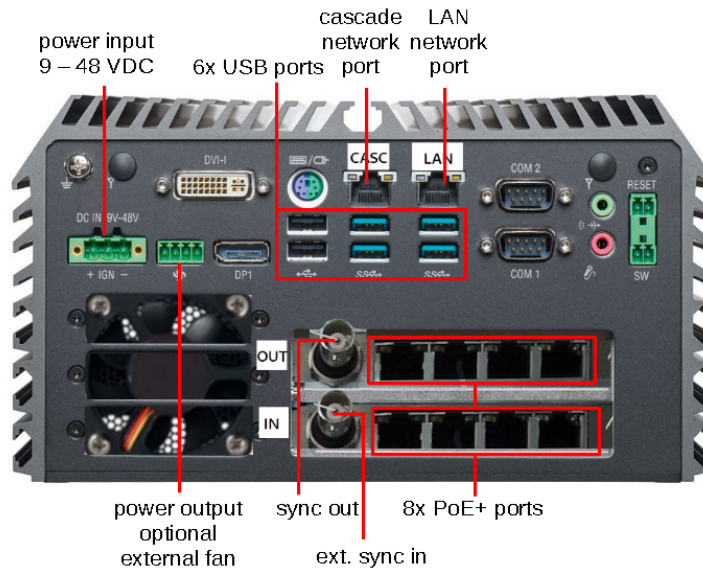

Figure 5.15: *ART Controller/M* back view

- **ART Synccard3 (IN & OUT) :**

- 'PoE+ ports':

All *ARTTRACK* as well as *TRACKPACK/E* cameras have to be plugged in here. In larger systems (> 6 *ARTTRACK5* and 8 *ARTTRACK6/M* or *ART-TRACK5/C* cameras only) connect the external PoE+ switch to any of these ports.

- **ART Synccard3 (IN ONLY):**

- 'ExtIn':

Please plug in the external source (TTL or video signal or master controller of a cascaded system) for synchronization here. Please use the port marked 'IN' only. For configuration refer to chapter 5.5 on page 65. In cascaded systems please connect the external source to the master controller only.

- **ART Synccard3 (OUT ONLY):**

- 'OUT':

This port is used as synchronization output (video signal) in syncgroup #1. For backwards compatibility connect *ARTTRACK1* – *ARTTRACK3* cameras here. Please refer to chapter 5.2.5.2 on page 60 for more detailed information.

5 System setup

When using **ARTTRACK1 – ARTTRACK3** cameras at least one camera has to be connected here if you are using active targets (e.g. **Fingertracking** , **Flystick3**). Refer to chapter 5.8.3 on page 92 for more information.

For cascaded systems please connect 'OUT' to 'ExtIn' of a slave controller (see chapter 5.6 on page 66).

- **'USB port'**:
Please plug in all USB based peripheral devices here (e.g. **RadioTransceiver2/3** for communication with **Flystick2/2+/3** (refer to chapter 4.4.2 on page 34), Trivisio wireless transceivers and Yost Labs wired inertial sensors (refer to **DTRACK3 User's Guide** → **Hardware** → **Inertial Sensors**) You can also plug-in a USB pen drive for accessing the **ART Controller/M** without the **DTRACK3** frontend (refer to **DTRACK3 User's Guide** → **Connecting to the controller**).
- **'LAN network port'**:
Please connect the **ART Controller/M** to your local network using a twisted pair Cat 5 cable.
- **'Cascaded network port'**:
For cascaded systems please connect a slave controller to the **ART Controller/M** (master). Please refer to chapter 5.6 on page 66 for more detailed information.
- **'Power input'**:
Please connect the external power supply, refer to chapter A.2 on page 130 for detailed information regarding technical specifications.
- **'Power output'**:
Please connect the optional external fan when using the **ART Controller/M** in environments with elevated temperatures.
- **'All other plugs & ports'**: These ports are unused and provide no functionality to the user. Please do not connect any devices.



The ART Controller/M offers synchronization output for ARTTRACK1 – ARTTRACK3 cameras on syncgroup #1 only !



The ART Controller/M is designed to operate with ARTTRACK6/M , ARTTRACK5 , ARTTRACK5/C and TRACKPACK/E cameras up to 140 Watt of combined power consumption!



The ventilation hole on the back of the ART Controller/M must not be covered. Ensure unblocked airflow at all times. The minimum distance between equipment and surrounding objects has to be larger than 3 cm.

5.2.5 Connecting cameras

5.2.5.1 Connection of *ARTTRACK6/M*, *ARTTRACK5*, *ARTTRACK5/C* or *TRACKPACK/E* cameras

Mount the cameras at the desired position before connecting the cables. These *ART* cameras are designed as a single cable solution for data, power and synchronisation.

Systems with *ART Controller* Up to 8 *ARTTRACK6/M*, *ARTTRACK5*, *ARTTRACK5/C* and *TRACKPACK/E* cameras can be connected via twisted pair cables (min. Cat 5, max. length 100 m) to the internal *ART Synccard3* of the *ART Controller* (see figure 5.16 on page 59). You can also build mixed systems connecting different camera models to the same *ART Controller*.

Systems with *ART Controller/M* When using the *ART Controller/M* the maximum amount of cameras is limited. A maximum of 6 *ARTTRACK5* or 8 *ARTTRACK6/M*, *ARTTRACK5/C* and *TRACKPACK/E* may be connected via twisted pair cables (min. Cat 5, max. length 100 m) to the internal *ART Synccard3* of the *ART Controller/M* (see figure 5.16 on page 59) respectively. You can also build mixed systems connecting different camera models to the same *ART Controller/M*.

Systems > 8 cameras In larger systems the use of an external PoE+ switch is necessary. The external PoE+ switch is then to be connected to any port on the *Synccard3*.

The camera IP addresses are predefined - changes by the user are not possible:



- IP address: 172.28.X.X
- subnet mask: 255.255.0.0



Do not connect *TRACKPACK/E* cameras via external PoE+ switches ! In case of mixed systems connect all *TRACKPACK/E* cameras directly to the *ART Controller* or *ART Controller/M*.



The *ART Controller/M* offers synchronization output for *ARTTRACK1* – *ARTTRACK3* cameras on syncgroup #1 only !



The *ART Controller/M* is designed to operate with *ARTTRACK6/M*, *ARTTRACK5*, *ARTTRACK5/C* and *TRACKPACK/E* cameras up to 140 Watt of combined power consumption!



Use only original components and accessories from *ART* or authorized by *ART*. Using unauthorized components or accessories may damage the equipment, may cause malfunctioning and may compromise operational safety.

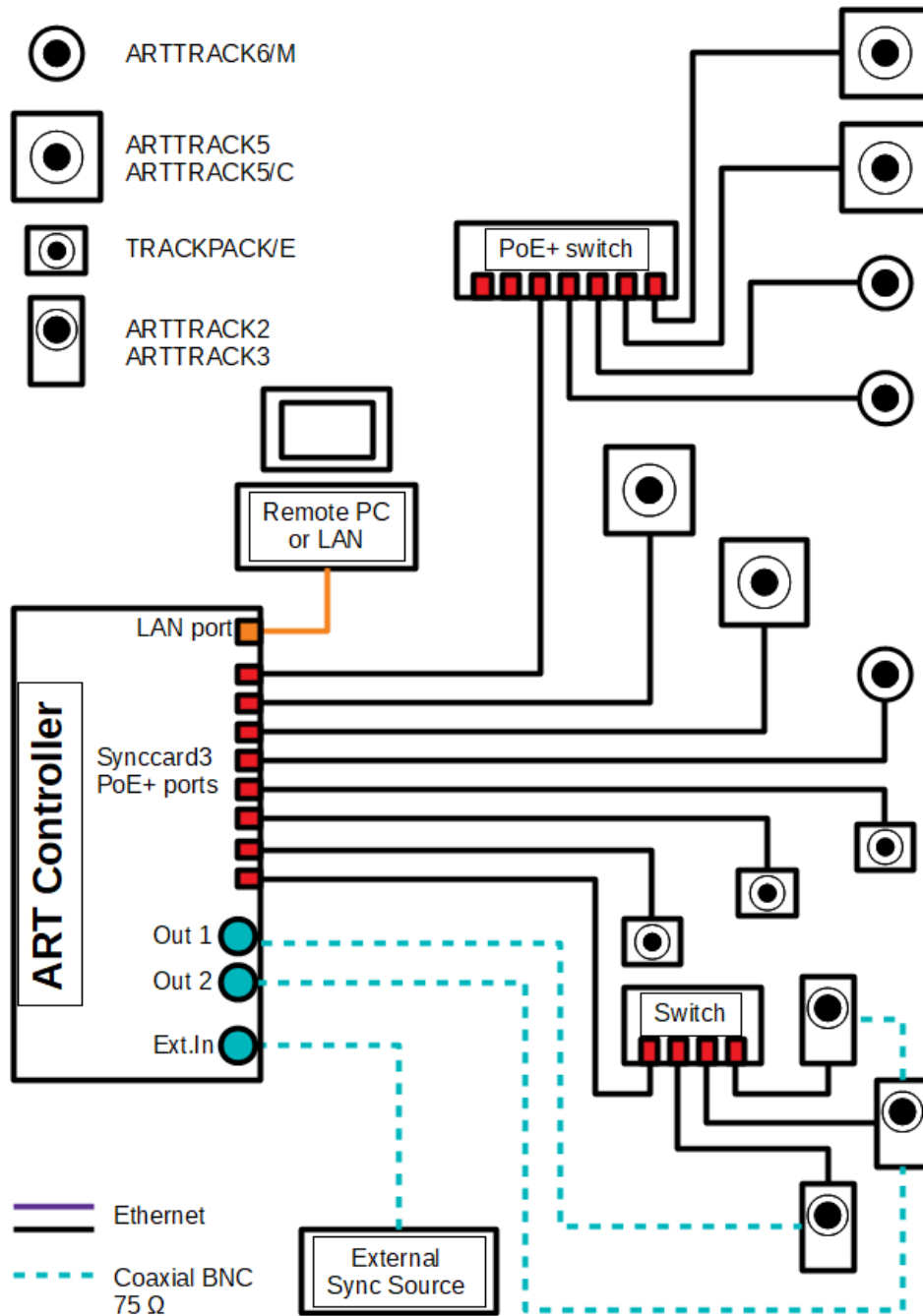

Figure 5.16: Connecting cameras to the *ART Controller* and *ART Controller/M*



In case connectivity is provided using third party equipment please ensure compliance to all applicable standards regarding connectivity and power supply (see chapter A on page 126). Non-compliance may result in loss of conformity ! All warranty and liability is void.

5.2.5.2 Connection of *ARTTRACK1* , *ARTTRACK2* or *ARTTRACK3* cameras (backwards compatible systems)

Data is transferred via twisted pair Cat 5 cables, while all synchronisation is transported via BNC connections. When connecting the synchronization cables it is important to correctly chain the cameras on the sync cable (see chapter 6.2 on page 119). There must be one continuous signal line terminated on both ends with 75Ω resistors, with the cameras and the *Synccard3* inserted by tee connectors. Do not extend the connection between the tee-connector and the camera nor branch the signal line (star wiring).

Typically all cameras are connected to the syncgroup #1 ('OUT1' on *ART Controller* and 'OUT' on *ART Controller/M*) of the *Synccard3* . If the cameras have to be grouped into different syncgroups, in order to avoid mutual blinding, two or three BNC chains are used with syncgroups #1 and #2 or #1, #2 and #3 of the *ART Synccard3* (compatibility ports) respectively.

 ***ARTTRACK2* and *ARTTRACK3* cameras have to be connected via any external ethernet switch or via the ART authorized PoE+ switches for larger systems. Do not connect *ARTTRACK2* or *ARTTRACK3* directly to the PoE+ ports of the *ART Synccard3* . Please refer to chapter 5.2 on page 52 for more detailed information.**

 **The *ART Controller/M* offers synchronization output for *ARTTRACK1* – *ARTTRACK3* cameras on syncgroup #1 only !**

5.2.6 Dynamically adding / removing of cameras

You can (dis-)connect additional cameras to the *ART Controller* or *ART Controller/M* without the need of restarting the controller. Please refer to *DTRACK3 User's Guide* → *Hardware* → *Search Hardware*) for details.

 ***DTRACK3* is able to operate when cameras have been added or removed; for best performance it is highly recommended to perform a room (re-)calibration**

5.3 Installation of the *SMARTTRACK3* & *SMARTTRACK3/M*

For the sake of readability the following section refers to the *SMARTTRACK3* in general. The *SMARTTRACK3* is a PoE device , so there is no power switch (see figures 5.17 on page 61 and 5.18 on page 61). It will start up as soon as the PoE injector is plugged into a mains socket.

5.3.1 Ports & Plugs on the *SMARTTRACK3*

The following list gives a short overview of all ports accessible to the user (see figures 5.17 on page 61 and 5.18 on page 61):

5 System setup

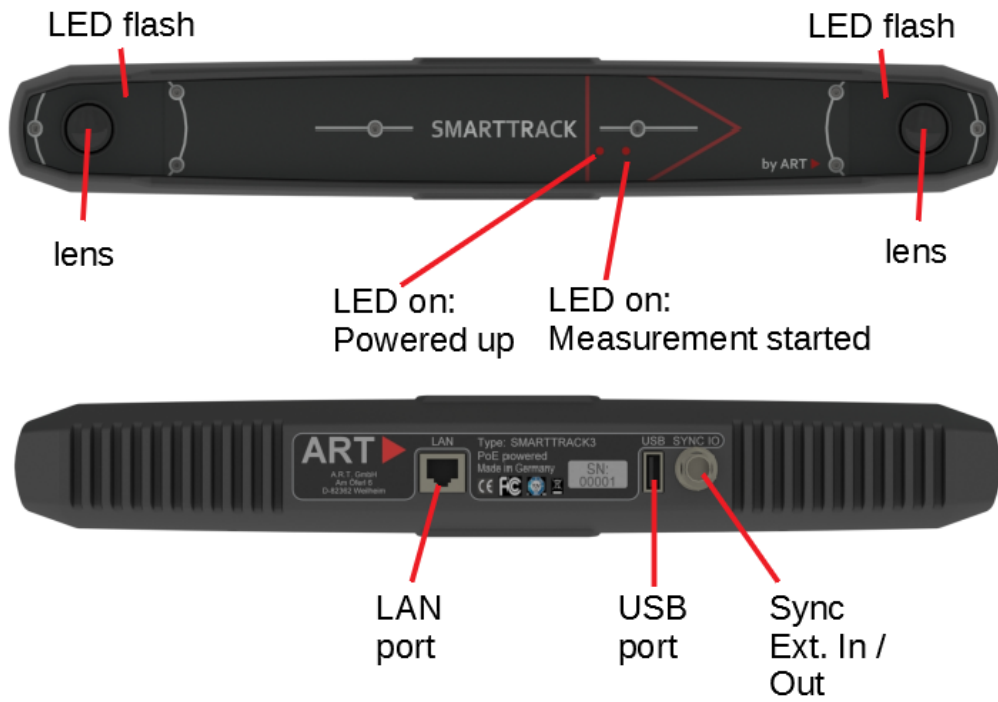

Figure 5.17: **SMARTTRACK3** - Front & Back view

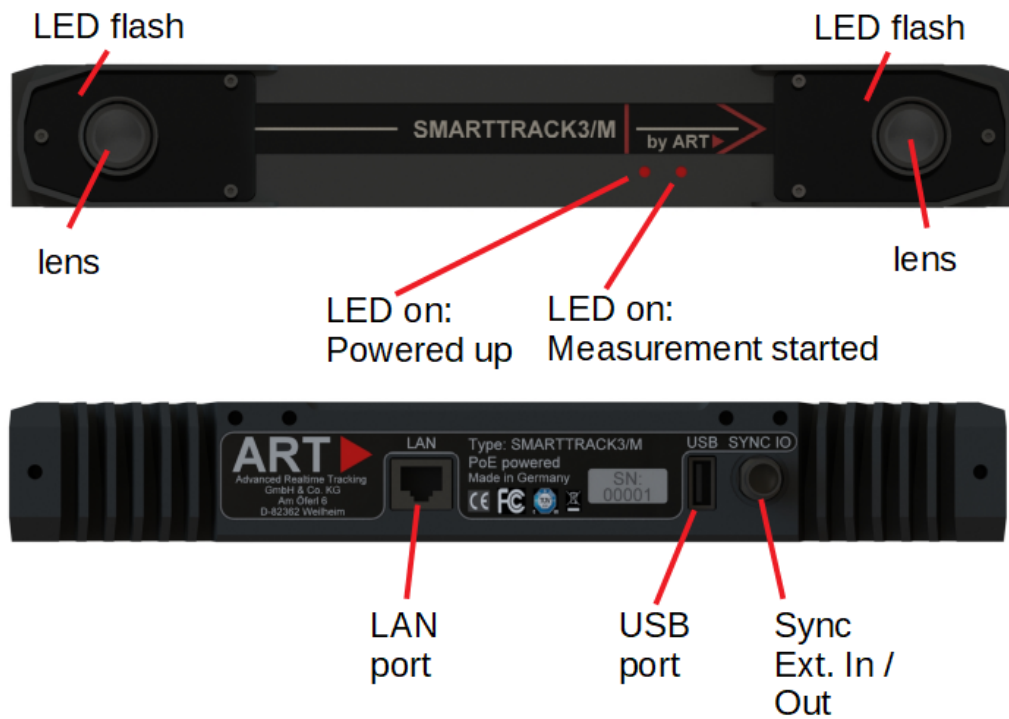

Figure 5.18: **SMARTTRACK3/M** - Front & Back view

- **'SYNC I/O':**
Please plug in the external source (TTL or video signal or master controller of a cascaded system) for synchronization here. For configuration refer to chapter 5.5 on page 65. In cascaded systems please connect the external source to the master controller only. When using the output functionality connect other equipment that should be triggered by the **SMARTTRACK3** (e.g. slave controller or other triggered devices).
- **'USB port':**
Please plug in all USB based peripheral devices here: e.g. **RadioTransceiver2/3** for communication with **Flystick2/2+/3** (refer to chapter 4.4.2 on page 34) or Yost Labs wired inertial sensors (refer to **DTRACK3 User's Guide** → *Hardware* → *Inertial Sensors*). You can also plug-in a USB pen drive for accessing the **SMARTTRACK3** without the **DTRACK3** frontend (refer to **DTRACK3 User's Guide** → *Connecting to the controller*).
- **'LAN port':**
Please connect the **SMARTTRACK3** to the external PoE injector and from there to your local network using a twisted pair Cat 5 cable.



The USB port is compliant to USB 2.0 (5 V max. 500 mA)



An externally powered USB hub is required when attaching multiple / high-power USB devices.

5.3.2 Connecting & starting the **SMARTTRACK3**

Usually a **SMARTTRACK3** would get its power via a PoE injector. The **'DATA+POWER'** port of the PoE injector provides power and ethernet data, while the **'DATA'** port just delivers ethernet data. Use one twisted pair Cat 5 cable to connect the **'DATA+POWER'** port of the PoE injector to the **SMARTTRACK3 'LAN'** port. Then connect the **'DATA'** port of the PoE injector to your LAN or to your remote PC. Use the power cord to connect the PoE injector to a mains socket (see figure 5.19 on page 63).

Alternatively use any **ART** authorized PoE+ switch to power the **SMARTTRACK3**.

5.4 Connection to local network LAN

The controller (integrated in **SMARTTRACK2/3/M**) uses the **'LAN network port'** (1000 Base-TX) for data output to the remote PC or to any PC within the local network. Figure 5.20 on page 64 shows two possibilities of connecting the controller to a local network. You may either use the controller as a DHCP client within your network (figure 5.20(a) on page 64), i.e. the tracking data is transmitted directly via your local network. Or in case of security restrictions (e.g. company guidelines, that do not allow to connect

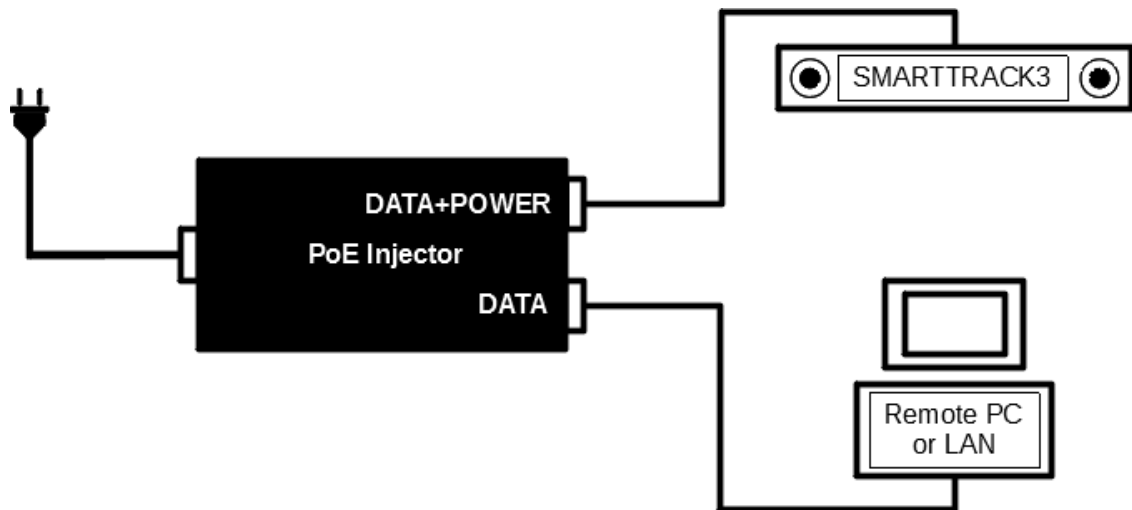

Figure 5.19: *SMARTTRACK3* & PoE Injector Installation

the controller to your network), you may install two network cards in your remote PC - one is connected to the controller and the other one is connected to your local network (figure 5.20(b) on page 64). In this case, the *DTRACK3* frontend will act as a router for the tracking data.

5.4.1 Connection to LAN using DHCP

By default the controller is set up to support DHCP. Therefore, it will acquire an IP address that is automatically provided by a DHCP server.

Double-check that the cameras are connected properly to the controller (in case of *ARTTRACK1*, *ARTTRACK2* or *ARTTRACK3* verify that they are powered up using their individual corresponding power supply), connect the 'LAN network port' to your local network. Connect the power plug of the controller / external power supply to a mains socket and turn on the controller. Finally, start the *DTRACK3* frontend software on the remote PC. Please refer to *DTRACK3 User's Guide* → *Connecting to the controller* for more details.



If the controller is not connected via an ethernet cable or no DHCP server is running, it will use a fall-back IP address (IP 192.168.0.1, subnet mask 255.255.255.0). Configure the IP address of your NIC accordingly.



In case of LANs protected by firewalls all necessary ports for *DTRACK3* network communication have to be unblocked. Please refer to section A.7 on page 141.

5.4.2 Connection to LAN using a static IP address

You may configure a static IP address the following ways:

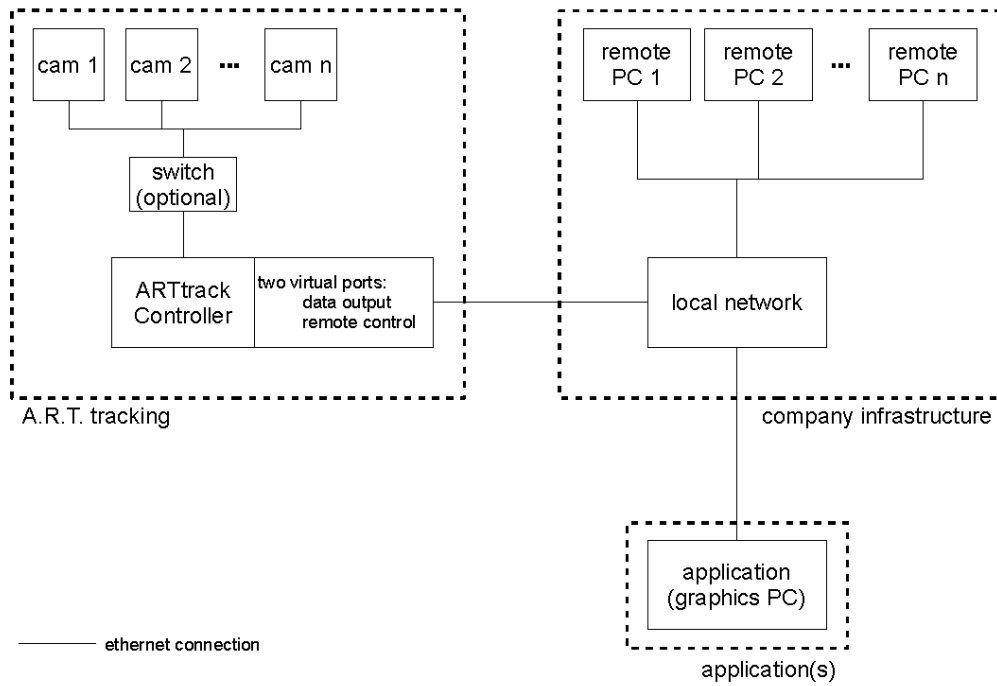

(a) standard connection

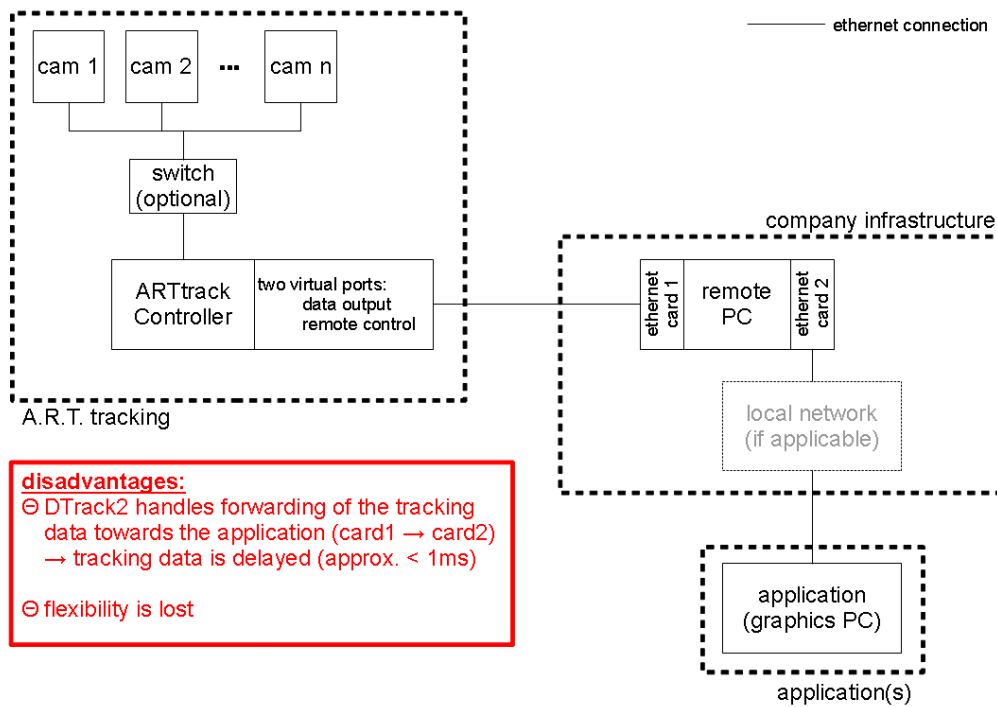

disadvantages:
 ⊖ DTrack2 handles forwarding of the tracking data towards the application (card1 → card2)
 → tracking data is delayed (approx. < 1ms)
 ⊖ flexibility is lost

(b) indirect connection

Figure 5.20: Connecting a controller or *SMARTTRACK2/3/M* to a local network

5 System setup

- using **DTRACK3** (refer to **DTRACK3 User's Guide** → *Hardware Configuration* → *Network*)
- without the **DTRACK3** frontend (refer to **DTRACK3 User's Guide** → *Connecting to the controller*)



Please note that these settings are not part of your personal configuration. Changes of the IP address will affect all users of your controller! Your controller may become unreachable with wrong IP settings! Refer to **DTRACK3 User's Guide → *Connecting to the controller*.**

5.5 Synchronization

5.5.1 Synchronization Input

All controllers and **SMARTTRACK2/3/M** can be synchronized with an external source. Typically, external synchronization has to be used when other systems inside the tracking system are also using infrared signals for controlling their equipment (e.g. if IR-controlled shutter glasses are used). The goal is to reduce or eliminate interference. The **ART** tracking system is triggered by the external synchronization signal and based on this trigger signal the system chooses time slots when it is safe to emit infrared radiation without causing interference. The effect is, for example, that active shutter glasses are not flickering but offer a stable picture for the user.

Synchronization signal The sync signal may be of type TTL (5V) or video. When using TTL you can select between rising and falling edge trigger and triggering on both edges (latter not available for **SMARTTRACK2**) Please refer to the **DTRACK3 User's Guide** → *Hardware Configuration* → *Synccard* to change settings. Use the BNC plug 'ExtIn' on the back of the controller ('*SYNC I/O*' for **SMARTTRACK3** & **SMARTTRACK3/M**) for the external synchronization input.



The external sync input is not internally terminated. When synchronizing with a video input, a tee connector with an external 75 Ω terminating resistor should be used if the signal line ends at the controller.





When using a TTL-signal you should not use a terminating resistor. However, you should use a shielded cable for the synchronization with a TTL-signal.

5.5.2 Synchronization Output

The **ART Controller** with optional synchronisation output '*OUT1-3*' for backwards compatibility, as well as the **ART Controller/M** and **SMARTTRACK3** & **SMARTTRACK3/M** can also be used to generate a trigger signal for other systems. This feature is mainly used





when building 'Cascaded Systems' or in installations where a common synchronisation source is necessary.

Synchronization signal The sync signal is of type video or TTL (5V, only available for *SMARTTRACK3* & *SMARTTRACK3/M*). When using TTL a rising edge trigger is used, refer to the *DTRACK3 User's Guide* → *Hardware Configuration* → *Synccard* to configure settings. Use the 'OUT1-3' on the *ART Controller*, the 'OUT' on the *ART Controller/M* and 'SYNC I/O' on the back of the *SMARTTRACK3* & *SMARTTRACK3/M* for the output trigger respectively.

-  **The external sync output is internally terminated.**
When using a video signal output, connect the signal line to the controller directly and do not use an external 75 Ω terminating resistor.
-  When using a TTL-signal as output you should not use a terminating resistor. However, you should use a shielded cable for the synchronization with a TTL-signal.
-  When using the 'SYNC I/O' on *SMARTTRACK3* & *SMARTTRACK3/M* as output no external synchronisation can be used and vice versa.

5.6 Cascaded systems

Cascading means that two or more stand-alone tracking systems are combined to one large tracking system. Consequently the system is divided into one master and up to eight slave controllers. The task of the master is to gather all camera data from all slaves and to merge them into one single data output. The *DTRACK3* frontend connects to the master only and allows to configure (e.g. cameras, output, tracking, etc.) the entire tracking system.

-  **The licensing scheme for the number of cameras in a Cascaded System is automatically derived from all licenses available in both master and slave(s) controllers, e.g. 8 *ARTTRACK5* on master + 4 *TRACKPACK/E* cameras on slave = license showing 12 cameras. Note: *SMARTTRACK3* & *SMARTTRACK3/M* count as two cameras each.**
-  **The total number of cameras in the cascaded system cannot exceed 16 for *TRACKPACK/E* only systems, i.e up to one slave controller is supported.**
-  **The total number of cameras in a Cascaded System cannot exceed 50. Note: *SMARTTRACK3* & *SMARTTRACK3/M* count as two cameras each.**
-  **The master controller needs to have a dedicated 'Cascaded Systems' license.**

5.6.1 Connecting a cascade

General requirements When building a cascaded system, please proceed according to the following description:

1. mount the cameras at the designated positions
2. connect all cameras to a corresponding controller
3. connect all peripheral devices to the master controller (e.g. *RadioTransceiver2/3* or inertial sensors)
4. establish a connection between the master controller and all slave(s) for data and synchronisation of the cascade (see 5.6.1.1 on page 67)



The ART RadioTransceiver2/3 for Flystick2/2+/3 has to be connected to the master controller.

5.6.1.1 Connecting cascaded controllers

Depending on your setup there are different options how to connect the single controllers to form a cascade.

Option 1 - using your local area network Connect the data output 'LAN network port' of all controller(s) (master & slave(s)) to the same local area network LAN or remote PC. All slave controllers have to be synchronized with the master controller via a BNC coaxial connection, see fig. 5.21 on page 71.

This connection option is valid for the following combinations:

- master: *ART Controller* & *ART Controller/M* with all camera models ↔ slave(s): *ART Controller* & *ART Controller/M* with *TRACKPACK/E* cameras
- master: *ART Controller* & *ART Controller/M* with all camera models ↔ slave(s): *TRACKPACK* controllers (discontinued) with *TRACKPACK* cameras (discontinued)
- master: *ARTTRACK* Controllers (discontinued) with *ARTTRACK2* & *ARTTRACK3* cameras (discontinued) ↔ slave(s): with *TRACKPACK/E* cameras
- master: *ARTTRACK* Controllers (discontinued) with *ARTTRACK2* & *ARTTRACK3* cameras (discontinued) ↔ slave(s): *TRACKPACK* controllers (discontinued) with *TRACKPACK* cameras (discontinued)
- master *ARTTRACK* Controllers (discontinued) with *ARTTRACK2* & *ARTTRACK3* (discontinued) ↔ slave(s): *SMARTTRACK3* & *SMARTTRACK3/M*



The total number of cameras in the cascaded system cannot exceed 16 for TRACKPACK/E only systems, i.e. up to one slave controller is supported.

 **Note:** *TRACKPACK* cameras are connected via two-cables (Firewire and proprietary Cat 5)

 **Note:** *ARTTRACK6/M & ARTTRACK5 & ARTTRACK5/C & TRACKPACK/E* are not compatible to *ARTTRACK* Controllers (discontinued)

Option 1b - SMARTTRACK3 & SMARTTRACK3/M only cascades Connect the data output 'LAN network port' of all *SMARTTRACK3* & *SMARTTRACK3/M* (master & slave(s)) to the same local area network LAN or remote PC. The *SMARTTRACK3* & *SMARTTRACK3/M* slaves have to be synchronized with the master via a BNC coaxial connection, see fig. 5.22(a) on page 71.

In case of external synchronisation connect the external signal to all *SMARTTRACK3* & *SMARTTRACK3/M* in the cascade using tee-connectors, see fig. 5.22(b) on page 71.

This connection option is only valid for:

- master: *SMARTTRACK3* & *SMARTTRACK3/M* ↔ slave(s): *SMARTTRACK3* & *SMARTTRACK3/M*

 **SMARTTRACK3 & SMARTTRACK3/M master can drive SMARTTRACK3 & SMARTTRACK3/M slaves only !**

 **Connect the external synchronisation signal to ALL SMARTTRACK3 & SMARTTRACK3/M in the cascade !**

Option 2 - using the dedicated 'Cascaded Network Port' (ART Controller and ART Controller/M only) Connect the data output 'LAN network port' of the slave controller(s) to the 'Cascaded Network Port' of the master. All slave controllers have to be synchronized with the master controller via a BNC coaxial connection, see fig. 5.23 on page 72).

This connection option is valid for the following combinations:

- master: *ART Controller* & *ART Controller/M* with all camera models ↔ slave(s): *ART Controller* & *ART Controller/M* with *TRACKPACK/E* cameras
- master: *ART Controller* & *ART Controller/M* with all camera models ↔ slave(s): *TRACKPACK* controllers (discontinued) with *TRACKPACK* cameras (discontinued)

 **The total number of cameras in the cascaded system cannot exceed 16 for TRACKPACK/E only systems, i.e up to one slave controller is supported.**

 **Please use a switch when connecting two or more TRACKPACK slave controllers to the 'Cascaded Network Port' of the ART Controller or ART Controller/M .**

 **TRACKPACK cameras are connected via two-cables (Firewire and proprietary Cat 5)**

Option 3 - using the *Synccard3 PoE+ ports* Connect each data output '*LAN network port*' of the *SMARTTRACK3* & *SMARTTRACK3/M* to the *ART Synccard3 PoE+* ports of the master. Synchronisation with the master controller is provided through the *Synccard3*, a BNC coaxial connection is not necessary, see fig. 5.24 on page 73).

This connection option is only valid for:

- master: *ART Controller* & *ART Controller/M* with all camera models ↔ slave(s): *SMARTTRACK3* & *SMARTTRACK3/M*



Do not use the PoE injector nor the BNC synchronisation when connecting *SMARTTRACK3* & *SMARTTRACK3/M* slaves to .

Option 4 - using the internal camera network (*ARTTRACK* Controllers (discontinued) only) Connect the data output '*LAN network port*' of the slave controller(s) to the *ART Synccard2* camera network of the master. All slave controllers have to be synchronized with the master controller via a BNC coaxial connection, see fig. 5.25 on page 74.

This connection option is only valid for:

- master: *ARTTRACK* controllers (discontinued) ↔ slave(s): *TRACKPACK* controllers (discontinued)

5.6.1.2 Starting the cascades

Double-check that the cameras are connected properly to each controller (in case of *ARTTRACK1*, *ARTTRACK2* or *ARTTRACK3* verify that they are powered up using their individual corresponding power supply). Connect the '*LAN network port*' to your local network and connect the power plug / external power supply of all controllers to a mains socket. Turn on the slave controllers first and wait for proper start-up (indicated by a beep), then turn on the master controller. Finally, start the *DTRACK3* frontend software on the remote PC and establish a connection to the master. Please refer to *DTRACK3 User's Guide* → *Connecting to the controller* for more details.



By default all controllers are set up to support DHCP. When building cascades via LAN (options 1a+b, see 5.21 on page 71) and fig. 5.22(a) on page 71 the controllers will acquire an IP address automatically given that a DHCP server is running.



If any slave controller is not connected via an ethernet cable or no DHCP server is running, it will use a fall-back IP address (IP 192.168.0.1, subnet mask 255.255.255.0) and you will not be able to connect to your slave controllers !



If the cascade is connected via the '*Cascaded network port*' of the *ART Controller* or *ART Controller/M* (options 2, see 5.23 on page 72), all slave controllers must be set to a specific static IP address in the subnet 172.29.xxx.xxx with subnet mask 255.255.0.0. Do not use IP addresses in the range from 172.29.0.1 to 172.29.0.20 ! Please refer to chapter 5.4.2 on page 63.



If the cascade is connected via the **ART Synccard3** of the **ART Controller** or **ART Controller/M** (option 3, see 5.24 on page 73), all **SMARTTRACK3** & **SMARTTRACK3/M** slaves must be set to a specific static IP address in the subnet 172.29.xxx.xxx with subnet mask 255.255.0.0. Do not use IP addresses in the range from 172.29.0.1 to 172.29.0.20 ! Please refer to chapter 5.4.2 on page 63.



If the cascade is connected via the **ART Synccard2** camera network (option 4, see 5.25 on page 74), all slaves must be set to a specific static IP address in the subnet 172.29.xxx.xxx with subnet mask 255.255.0.0. Do not use IP addresses in the range from 172.29.0.1 to 172.29.0.20 ! Please refer to chapter 5.4.2 on page 63.

5 System setup

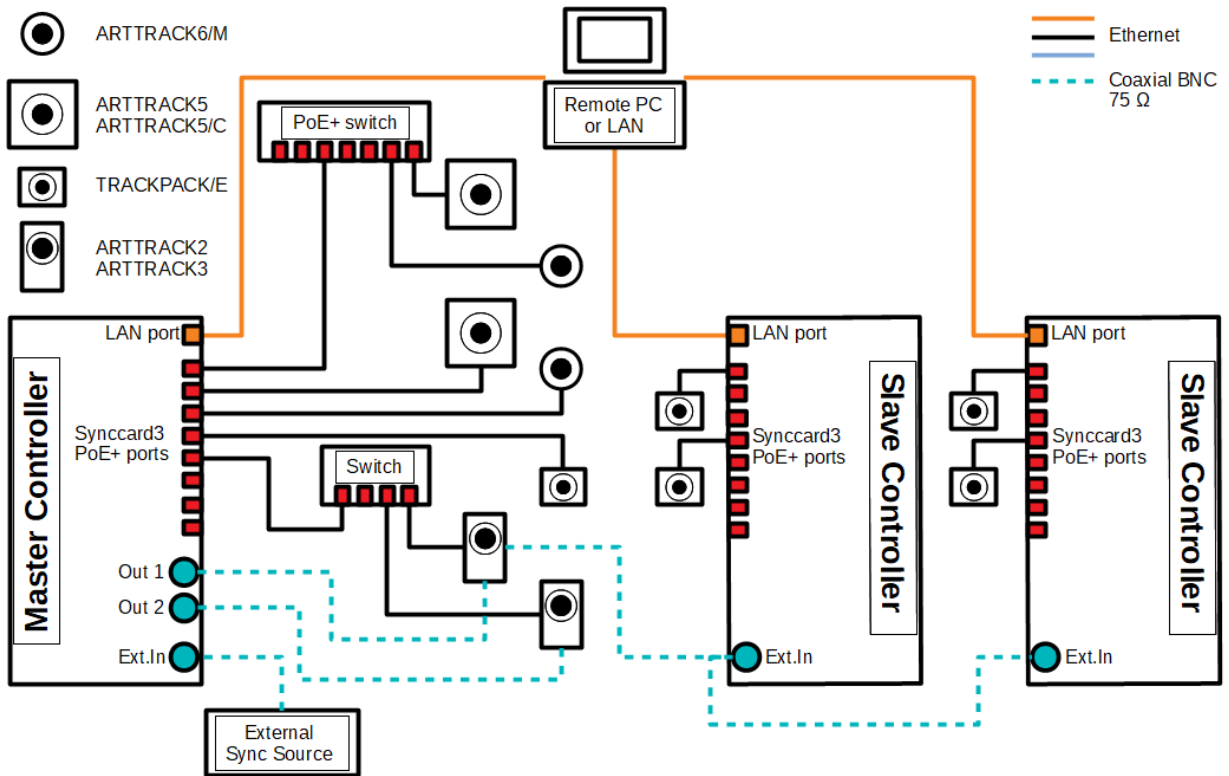
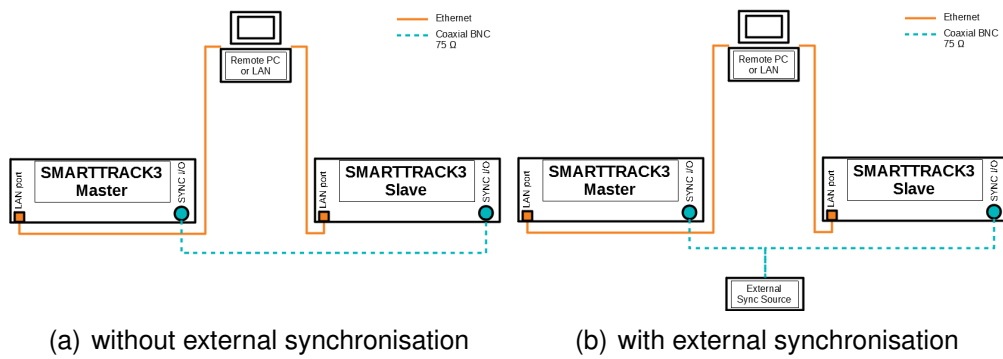

Figure 5.21: Principle of cascading using the LAN



(a) without external synchronisation

(b) with external synchronisation

Figure 5.22: Principle of cascading master **SMARTTRACK3** & **SMARTTRACK3/M** - slave **SMARTTRACK3** & **SMARTTRACK3/M**

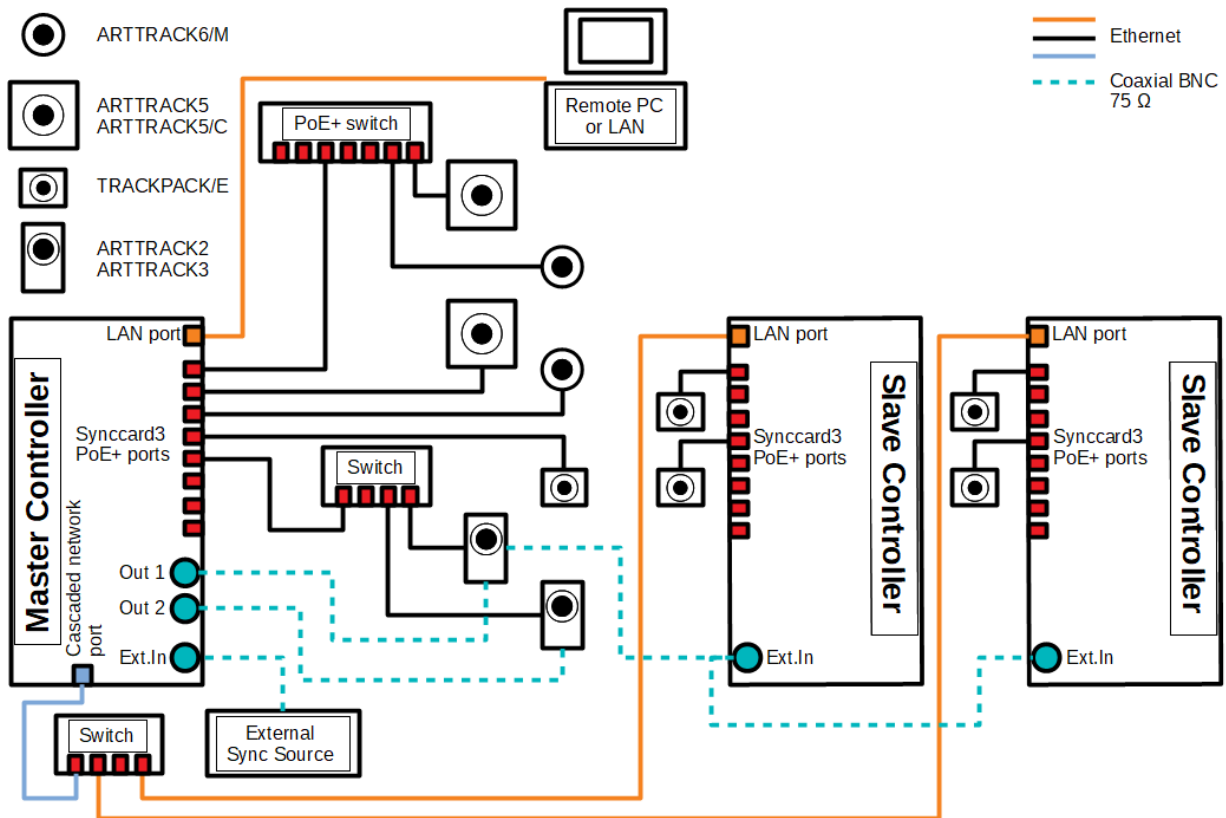

Figure 5.23: Principle of cascading using 'Cascaded Network Port'

5 System setup

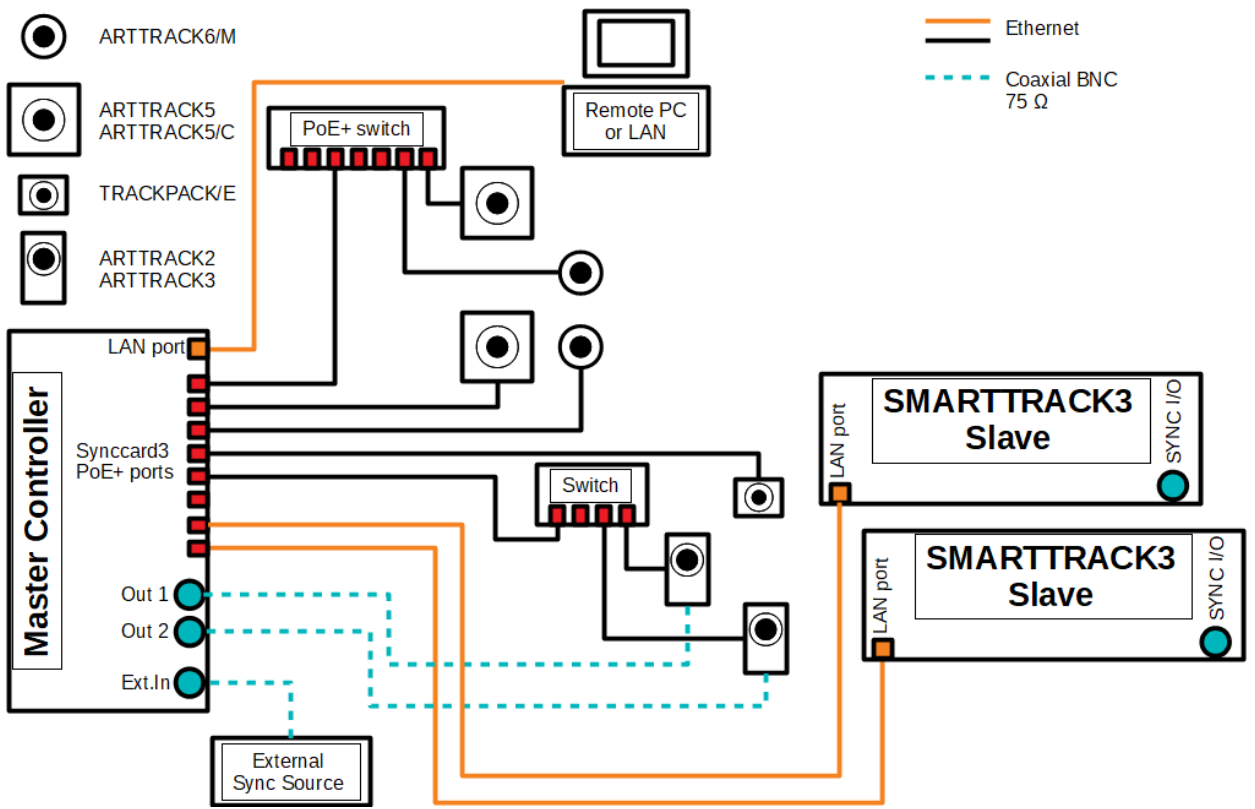

Figure 5.24: Principle of cascading master *ART Controller* or *ART Controller/M* - slave *SMARTTRACK3* & *SMARTTRACK3/M*

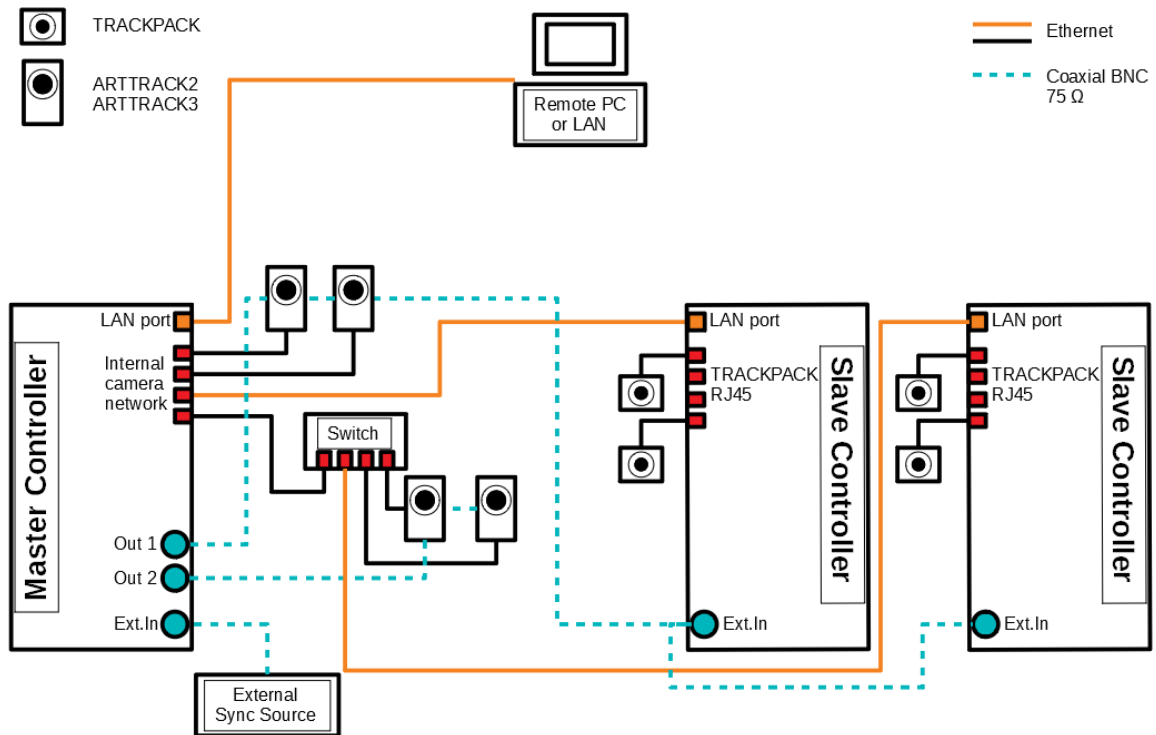

Figure 5.25: Principle of cascading using the internal camera network (discontinued)

5.7 Markers and targets (rigid bodies)

5.7.1 Passive markers

Basics Passive markers used in **ART** tracking systems are retro-reflective, which means they reflect a high fraction of the incoming light in a small cone around the incoming light's direction (cat's eye effect). More precisely the IR radiation is reflected into a narrow range of angles around the (opposite) direction of the incoming light. Passive markers used by **ART** are mostly spheres covered with retro-reflecting material. However, they also flat markers can be used (i.e. stickers made from retro-reflecting material).

The different types have distinctive advantages / disadvantages:

- **spherical markers:**

- + excellent visibility from any perspective,
- expensive fabrication,
- sensitive surface,
- target requires larger volume → danger of mechanical damage.

- **flat markers:**

- + low price,
- + flat targets possible,
- + robust surface because cover may be applied,
- the angular range of visibility is limited to approx. $\pm 45^\circ$.

- **ring markers:**

- + low price,
- + cylindrically shaped targets possible,
- + robust surface,
- the angular range of visibility is limited to approx. $\pm 45^\circ$.

Retro reflecting sheets or foils available on the market can be based on two different optical principles:

Triple mirrors, which are arranged such that their planes form angles of 90° by pairs, are reflecting light in the described way. Mostly foils with arrangements of many very small mirrors in a plane are used.

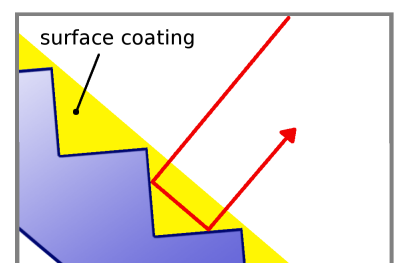

Glass spheres (with a proper refraction index) are focussing incoming light approximately to the opposite surface of the ball. A layer of microscopic glass spheres, carried by a reflecting material, acts as a retro reflector. These foils can be fabricated on a flexible carrier material, thus they are widely used for equipping spherical markers with retro reflecting surfaces.

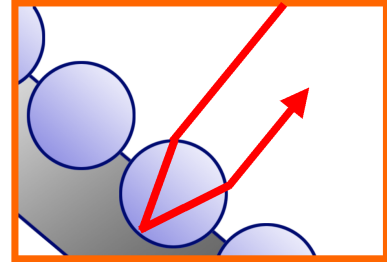

ART spherical markers are covered with retro reflecting foils, based on the glass spheres principle.



The quality of the markers decreases when they are in contact with dust, dirt, fat, liquids, glue or comparable contaminants. Please make sure that the markers are not touched or damaged.

5.7.2 Active markers

Basics Active markers are light (i.e. infrared light) emitting elements, usually LEDs.

In **ART** tracking systems four types of LED-based active markers may be used, depending on the application:

Single LEDs without diffusor sphere:

- + can be covered with acrylic protection film,
- + results in simple and robust markers providing visibility up to high distances (up to 10m),
- the angular range of visibility is limited to approx. $\pm 60^\circ$.

Single LEDs with diffusor sphere:

- + for optimum angular range of visibility,
- distance between marker and tracking camera is limited to a short distance (up to 4.5m).

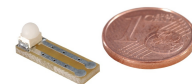

5 System setup

Big active spherical markers:

- + several single LEDs per marker, covered with light scattering spheres,
- + provide visibility from all sides and up to very high distances (approx. 20m),
- + suitable for outdoor tracking,
 - diameter: 50mm,
 - weight: 50g.

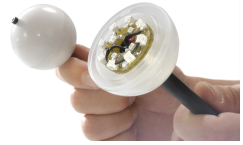

Big active flat markers:

- + several single LEDs per marker, covered with light scattering surface,
- + tracking up to very high distances (approx. 20m),
- + suitable for outdoor tracking,
- + magnetic base for easy positioning on metal surfaces,
 - the angular range of visibility is limited to less than 180°,
 - diameter: 30mm.



All active markers provided by **ART** are controlled by a special PC board and need power supply.

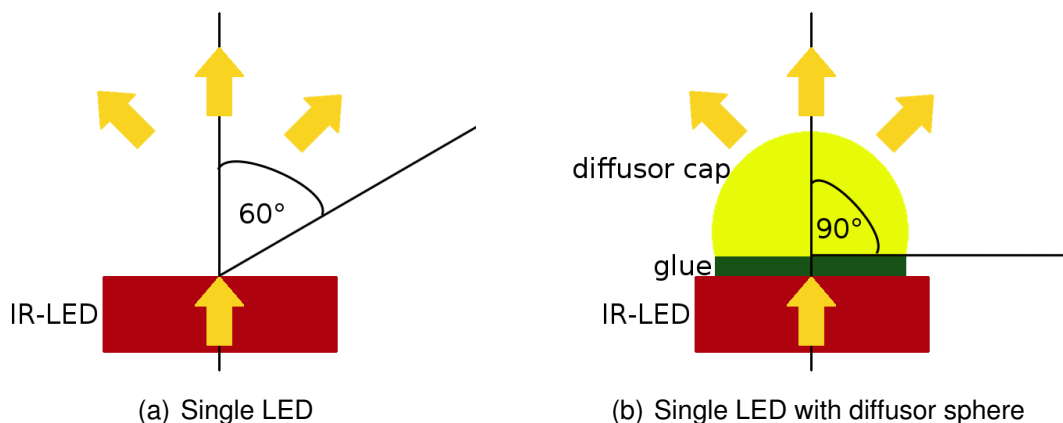







Figure 5.26: Angular range of visibility



Synchronization of active markers The easiest way to create an active marker is to have it emit IR light continuously. However, this would be inefficient in respect to energy dissipation and would yield low signal-to-noise ratios. *ART* tracking cameras have very short exposure times, i.e. narrow time slots of sensitivity. Most of the light emitted by the markers would hit the cameras sensors at times when it is inactive rendering the light useless for tracking. As a consequence, the range between cameras and marker would become significantly shorter. Additionally the active markers can be configured to emit high power intensities by flashing just like the camera flash. This also helps with energy dissipation due to an upper limit allowed for each single LED. Therefore, most active markers supplied by *ART* are synchronized with the cameras to emit radiation only during exposure times. This allows both more robust and longer ranging targets.

Synchronization can be done either by a wired connection between the tracking system and the pc-board controlling the active markers but also in a wireless way. For wireless synchronization a coded (i.e. modulated) IR flash is being sent out by a tracking camera. The active marker's PC board recognizes the coded flash and activates the LEDs.

∞ 5.7.3 Standard targets

Type	Description	Weight	approx. Dimension	Marker size
Hand target 	<p>The hand target is designed for hand tracking in usability and assembly studies respectively. It is also frequently used as a small general-purpose target. Due to the small size this target is easily occluded by the hand carrying it. Therefore, proper arrangement of tracking cameras has to be used in order to avoid occlusions.</p>	25g / 0.9oz	(110 × 80 × 28)mm	12mm
Large hand target 	<p>This hand target is designed for hand tracking in a two camera tracking system. Its large size allows to move the hand in almost all directions, without losing tracking.</p>	30g / 1.1oz	(170 × 120 × 35)mm	12mm
Claw target 	<p>The claw target looks just the same as the hand target. But it comes in a bigger size and is equipped with bigger markers.</p>	35g / 1.2oz	(160 × 110 × 30)mm	16mm

Type	Description	Weight	approx. Dimension	Marker size
<p>Tree target</p> 	<p>Originally designed for tracking HMDs, the tree target is a general-purpose target for tracking from longer distances. It is equipped with 20mm markers.</p>	<p>75g / 2.65oz</p>	<p>(195 × 170 × 120)mm</p>	<p>20mm</p>
<p>Generic glasses target</p> 	<p>For head tracking mostly in passive stereo systems, tracking targets must be fixed to the stereo glasses. <i>ART</i> offers several light-weight standard targets for this purpose.</p>	<p>min: 14g / 0.5oz max: 22g / 0.7oz</p>	<p>(270 × 120 × 35)mm</p>	<p>12mm</p>
<p>INFITEC PREMIUM target</p> 	<p>Target tailored to the INFITEC PREMIUM passive stereo glasses.</p>	<p>26g / 0.9oz</p>	<p>(225 × 85 × 80)mm</p>	<p>12mm</p>

Type	Description	Weight	approx. Dimension	Marker size
CrystalEyes® 2/3 target 	Target tailored to the shutter glasses of the StereoGraphics active stereo system. It fits to both CrystalEyes® 2 and 3.	28g / 1oz	(215 × 120 × 60)mm	12mm
CrystalEyes® 5 target 	Target tailored to the shutter glasses of the StereoGraphics active stereo system. It fits to the CrystalEyes® 5.	19g / 0.7oz	(195 × 105 × 40)mm	12mm
NuVision APG6000 and APG6100 target 	Target tailored to the NuVision APG6000 and APG6100 shutter glasses.	17g / 0.6 oz	(220 × 125 × 75)mm	12mm

Type	Description	Weight	approx. Dimension	Marker size
Volfoni EDGE [®] target	Target tailored to the Volfoni EDGE [®] shutter glasses.	23g / 0.7 oz	(230 × 95 × 60)mm	12mm
				
NVIDIA 3D Vision [®] Pro target	Target tailored to the NVidia 3D Vision Pro shutter glasses.	25g / 0.9 oz	(225 × 100 × 60)mm	12mm
				
NVisor SX 60 target	Target tailored to the NVisor SX 60 head mounted display.	55g / 1.94oz	(300 × 215 × 35)mm	12mm
				

Table 5.3: Standard targets overview

5.8 Interaction devices

5.8.1 Flystick2+

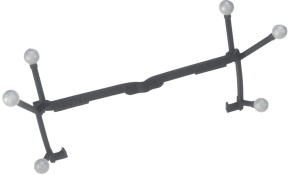
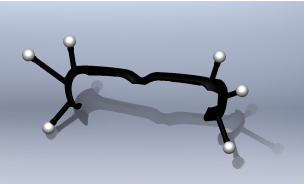
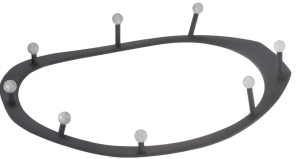

The batteries must be removed before shipping the Flystick2+, otherwise the radio transmitter could be started by shock or vibration.

Description The *Flystick2+* is a wireless input device for *ART* infrared optical tracking systems. The *Flystick2+* has an analogue trigger, six buttons and an analogue joystick with an additional button functionality (see figure 5.27 on page 83). For durability against impacts (e.g. dropping the device) the *Flystick2+* features two detachable marker compartments protected by cone-shaped enclosures. Both compartments are held magnetically and are secured by plastic safety wires. Additionally, the *Flystick2+* offers a vibration motor for inducing feedback patterns and a beep function.

Input transactions (buttons & joystick) are transmitted via low-rate wireless personal area network (IEEE 802.15.4) to the controller and added to the 6DOF tracking result of the *Flystick2/2+/3* bodies. Tracking and interaction data are then transmitted to the application via Ethernet.



Figure 5.27: *Flystick2+*



The *Flystick2+* has no power switch. It is activated automatically within a few seconds after a button event (#1, #3 - #7) and is deactivated after 10 minutes without usage.



The *Flystick2+* is tracked via passive markers which are covered by an acrylic housing. This means that 6DOF tracking is still valid when the *Flystick2+* electronics is off.

5.8.1.1 Control elements

The numbering sequence of the buttons is as follows (see also figure 5.28 on page 84):

- # 1 trigger
- # 2 - # 5 colored buttons, right to left
- # 6 pressing the joystick
- # 7 - # 8 grey buttons, left to right

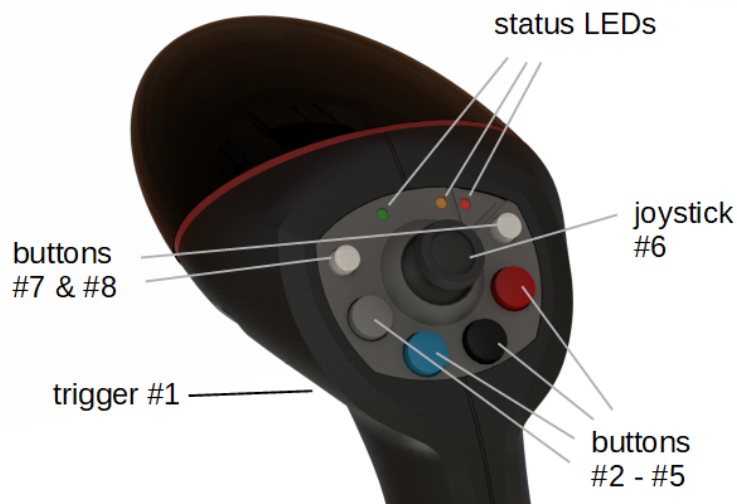

Figure 5.28: *Flystick2+* control elements

Top View	Event	Description
green status LED	flashing	active radio transmission (e.g. button pressed or joystick position successfully transmitted)
yellow status LED	flashing	→ indicates assignment process to controller & radio communication
red status LED	flashing	→ indicates low battery, recharge soon
	active continuously	→ battery charging
trigger, buttons & joystick	press	invoke an interaction which can be defined in the user application (e.g. drag objects while button trigger pressed, open a menu dialogue, ...)

Table 5.4: Description of the *Flystick2+* Control Elements

The *Flystick2+* device provides all functions (buttons, trigger and joystick) simultaneously. In neutral position the joystick transmits $x=0$, $y=0$.

5 System setup

- Moving left creates negative x values, moving right positive x values.
- Moving down creates negative y values, moving up positive y values.
- Full extension into any direction creates values of 1.0 or -1.0.

Additionally, the *Flystick2+* offers:

- one vibration motor for vibrational feedback patterns
- beep function

5.8.1.2 Data output

The output data consists of:

- position and orientation of the Flystick,
- status of buttons and joystick,
- number of used *Flystick* .

Please refer to the *DTRACK3 Programmer's Guide* → *Output of Measurement Data via Ethernet* for more information about the format of the output data.

5.8.1.3 Feedback control

Flystick2+ offers a list of control commands to address the feedback and beep function within your application. These consist of:

- the *beep duration* and *beep frequency*
- the *vibration pattern ID*

Please refer to *DTRACK3 Programmer's Guide* → *Input of Control Data via Ethernet* for details.

5.8.1.4 Batteries

The battery compartment is at the lower end of the handle. Remove the cover of the battery compartment (see figure 5.29 on page 86). Then insert the batteries taking care of the polarity - also note the imprinting '+' -' on the handle. Close the compartment after inserting the batteries.



2 standard AA rechargeable batteries are provided with the *Flystick2+* .



Dispose of used batteries at dedicated battery collection points and recycling facilities only! Batteries should never be disposed of along with household waste.

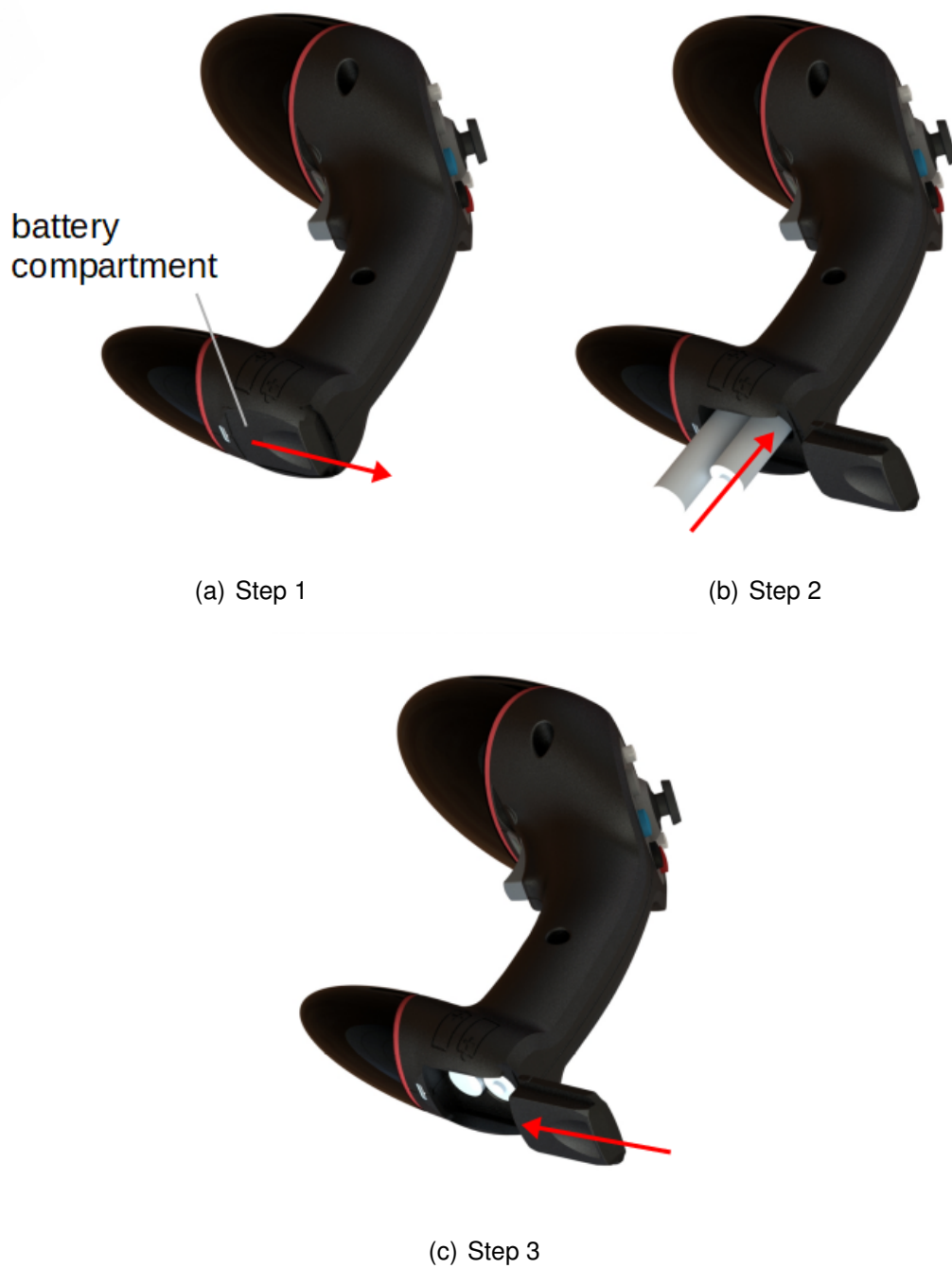

Figure 5.29: *Flystick2+* - inserting the batteries



Do not use non-rechargeable batteries - Risk of explosion !



Insert the rechargeable batteries into the battery compartment in the indicated polarity - Risk of explosion !

5.8.1.5 Charging jack

The charging jack is at the bottom of the handle and has to be connected with the supplied battery charger (see figure 5.30 on page 87).

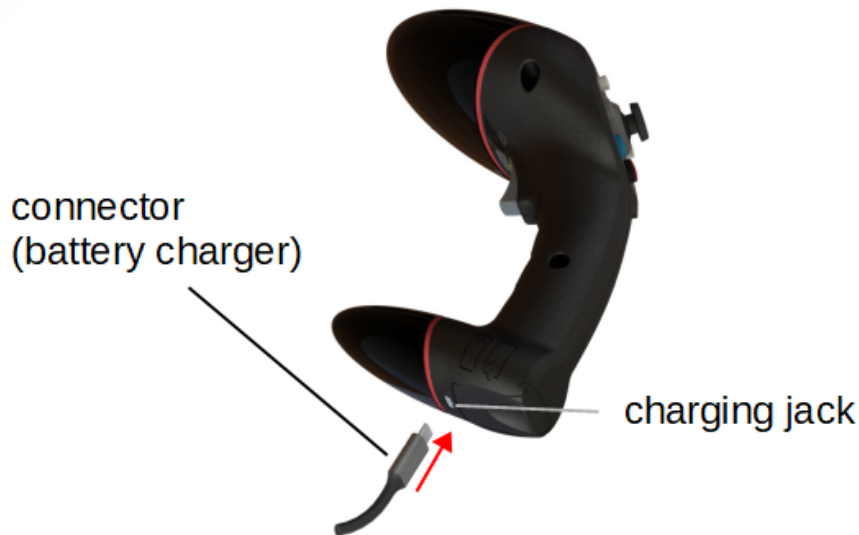

Figure 5.30: Charging the battery of the *Flystick2+*



After connecting the battery charger the *Flystick2+* may still be used during the charging process !



To ensure long battery life, do not let the batteries become discharged completely. Recharge whenever convenient.



Use the supplied charger authorized by ART only ! Do not charge for > 24 h.

5.8.1.6 Battery charger

A battery charger is supplied with the *Flystick2+* and must be used for charging the batteries.

Charging the batteries As soon as the charger is connected to *Flystick2+* the charging process is started (red status LED: continuously active). Once the battery pack is fully charged (approx. 5 h) the batteries may be used again (red status LED: off).



The batteries may remain inside the *Flystick2+* for charging.

5.8.1.7 Radio module

The *Flystick2+* uses a low-rate wireless personal area network (IEEE 802.15.4) radio module in the 2.4GHz band. This band is standardized internationally and can be used

without a license. Range with line of sight is more than 7m but can be reduced when the signal penetrates material, e.g. projection screens.

5.8.2 Flystick2



The batteries must be removed before shipping the Flystick2, otherwise the radio transmitter could be started by shock or vibration.

Description The *Flystick2* is a wireless input device for *ART* infrared optical tracking systems. The *Flystick2* has a trigger, four buttons and an analogue joystick with an additional button functionality (see figure 5.31 on page 88). All interactions are transmitted wirelessly via a 2.4 GHz ISM radio connection. Input transactions (buttons & joystick) are transmitted via low-rate wireless personal area network (IEEE 802.15.4) to the controller and added to the 6DOF tracking result of the *Flystick2/2+/3* bodies. Tracking and interaction data are then transmitted to the application via Ethernet.



Figure 5.31: *Flystick2*



The *Flystick2* has no power switch. It is activated automatically within a few seconds after any button event and is deactivated after several minutes without usage.



The *Flystick2* is tracked via passive markers which are covered by an acrylic housing. This means that 6DOF tracking is still valid when the *Flystick2* electronics is off.

5.8.2.1 Control elements

The numbering sequence of the buttons is as follows (see also figure 5.32 on page 89):

- # 1 trigger
- # 2 - # 4 blue buttons, right to left
- # 5 pressing the joystick



Figure 5.32: *Flystick2* control elements

Top View	Event	Description
	green pulse	button pressed or joystick position successfully transmitted
status LEDs	yellow pulse	button pressed or joystick position could not be transmitted
	yellow flickering	low battery, recharge soon
trigger, button and joystick		press the trigger or any button to invoke an interaction which can be defined in the user application (e.g. drag objects while button trigger pressed, open a menu dialogue, ...)

Table 5.5: Description of the *Flystick2* Control Elements

The *Flystick2* device provides all functions (buttons, trigger and joystick) simultaneously. In neutral position the joystick transmits $x=0$, $y=0$.

- Moving left creates negative x values, moving right positive x values.
- Moving down creates negative y values, moving up positive y values.
- Full extension into any direction creates values of 1.0 or -1.0.



In case you need to carry out a factory reset for the *Flystick2* you just have to plugin the charger into the charging jack.

5.8.2.2 Data output

The output data consists of:

- position and orientation of the Flystick,
- status of buttons and joystick,
- number of used *Flystick2/2+/3* .

Please refer to the *DTRACK3 Programmer's Guide* → *Output of Measurement Data via Ethernet* for more information about the format of the output data.

5.8.2.3 Battery pack

The battery compartment is at the lower end of the handle. It is fixed with a single screw which can be opened with the supplied 2mm allen key. Remove the screw and take off the cover of the battery compartment. Insert the battery pack taking care of the polarity - also note the imprinting "<<INSERT<<" on the battery pack. Apply the cover of the battery compartment again and fix the screw (see figure 5.33 on page 90).

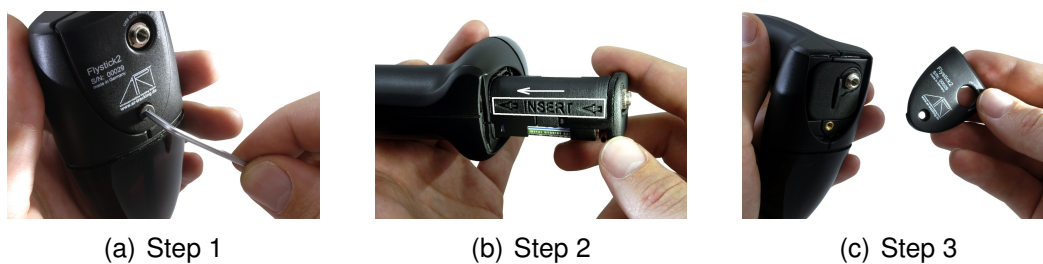

Figure 5.33: *Flystick2* - inserting the battery pack



The battery pack includes 3 standard AAA rechargeable batteries.



Dispose of used batteries at dedicated battery collection points and recycling facilities only! Batteries should never be disposed of along with household waste.



Do not use non-rechargeable batteries - Risk of explosion !



Insert the rechargeable batteries into the battery pack in the indicated polarity - Risk of explosion !

5.8.2.4 Charging jack

The charging jack is at the bottom of the handle and has to be connected with the supplied battery charger (see figure 5.34 on page 91).



Figure 5.34: Charging the battery of the *Flystick2*



Upon connecting the battery charger the *Flystick2* electronics are disconnected to prevent damage. The *Flystick2* cannot be used during the charging process !



To ensure long battery life, do not let the batteries become discharged completely. Recharge whenever convenient.



Use the supplied charger authorized by *ART* only ! Do not charge for > 24 h.

5.8.2.5 Battery charger

A battery charger is supplied with the delivered *Flystick2* and must be used for charging the batteries.

Charging the battery pack As soon as the battery pack is connected to the charger the initialisation starts (status LED: Yellow). After a few seconds the charger switches to the fast-charge mode (status LED: Orange). Once the battery pack is fully charged (approx. 1 h) the charger balances the cells inside the battery pack ('top-off charge mode', status LED: Green with intermittent yellow flash) to help extend battery life. Hereafter the charger goes into trickle charge mode automatically (status LED: Green). Now, the battery pack may be used again.

Please also refer to table 5.6 on page 92 for an overview of the status LEDs on the battery charger.



The batteries may remain inside the *Flystick2* for charging. However, during the charging process the *Flystick2* cannot be used.

status LED colour	Description
Yellow	No battery pack connected or initialisation
Orange	Fast charge
Green with Yellow flash	Top-off charge (balancing)
Green	Trickle charge (charging completed)
Flickering Orange - Green	Error (disconnect !)

Table 5.6: *Flystick2* battery charger status LEDs quick reference

5.8.2.6 Radio module

The *Flystick2* uses a low-rate wireless personal area network (IEEE 802.15.4) radio module in the 2.4GHz band. This band is standardized internationally and can be used without a license. Range with line of sight is more than 7m but can be reduced when the signal penetrates material, e.g. projection screens.

5.8.3 FINGERTRACKING2

Description The *ART FINGERTRACKING2* system allows measuring the position of the hand and the finger bones. To achieve this, a 6DOF target is attached to the palm of the hand and thimbles with 2 markers are worn on the measured finger tips (see figure 5.35 on page 93). All other information is derived from the kinematics of the hand, which are measured by a short calibration process.

The active markers for the finger tips are sequentially addressed to allow the tracking system to discriminate between the single fingers. Therefore the update rate of the fingers is only a fraction of the tracking frequency for the hand target, i.e. one-third for 3 thimbles and one-fifth for 5 finger tracking.

 ***FINGERTRACKING2* and *FINGERTRACKING2 Tactile* are not available for *SMARTTRACK2/3/M***

 **The tracking frequency for each finger is dependent on the number of finger thimbles, i.e. using 300 Hz tracking frequency this corresponds to 60 Hz for each finger (*FINGERTRACKING2* 5 finger thimble set) or 100 Hz (*FINGERTRACKING2 Tactile* 3 finger thimble set and/or tactile feedback)**

General specifications There are two different *FINGERTRACKING2* versions available, *FINGERTRACKING2* and *FINGERTRACKING2 Tactile*.

All *FINGERTRACKING2* devices consist of:

- a hand target unit for fixing on the back of the hand with IR LEDs (active markers) for tracking (see figure 5.36 on page 94).
- three or five finger thimbles (a fixture for the finger tip), each featuring IR LEDs connected via flexible wires (see figure 5.39 on page 96)
- wireless synchronization using a receiver for a coded IR flash (modulated flash)



Figure 5.35: *FINGERTRACKING2* and *FINGERTRACKING2 Tactile* device (shown with three active finger markers)

- rechargeable batteries and a battery charger

Additionally, the *FINGERTRACKING2 Tactile* has:

- one vibration motor for tactile feedback on each thimble
- radio module in the hand unit for addressing the vibration motors

5.8.3.1 *FINGERTRACKING2* and *FINGERTRACKING2 Tactile* Hand Targets

On/Off switch Move the switch to the *On* position to turn on the hand target unit. The vibration motors are started sequentially as a test run (*FINGERTRACKING2 Tactile* only). After turning on the hand target unit, the status LEDs light up according to table 5.7 on page 94. In *Off* position the hand target is switched off completely. There is no need to remove the batteries when not using the devices for a longer period of time.

L/H switch Move the switch to *H* position to increase the brightness of the IR LEDs if necessary, e.g. at far distances (> 3 m) from the cameras. Extend the battery lifetime by switching to *L* position.

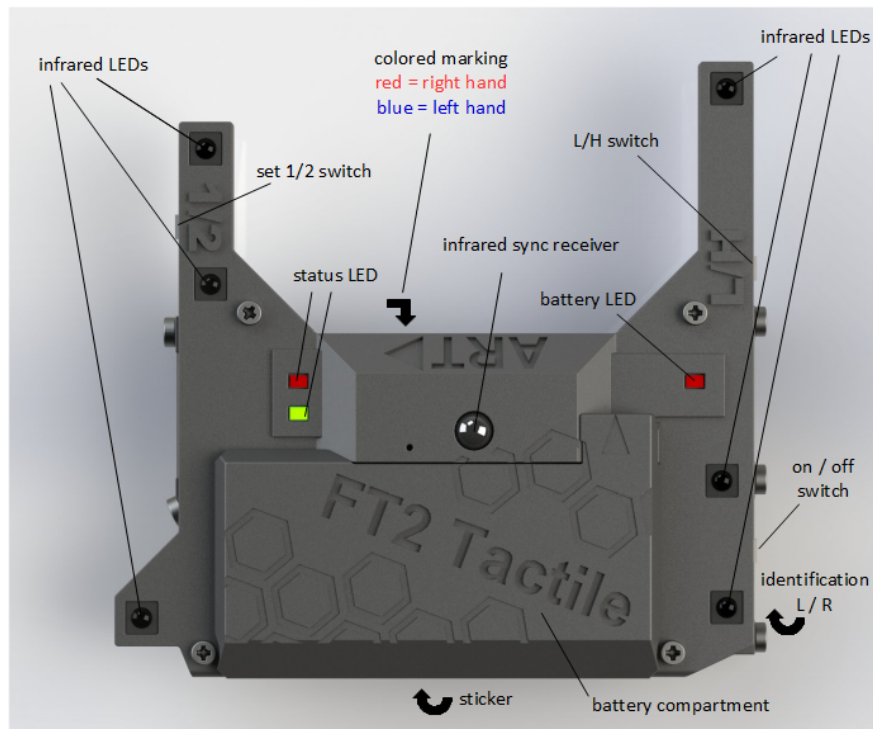
Figure 5.36: *FINGERTRACKING2* and *FINGERTRACKING2 Tactile* hand target

Top View	Event	Description
green status LED	continuously flashing	→ synchronization received and tracking → assigned to a controller, no active tracking (tactile only)
red status LED	active	→ indicates radio communication (tactile only)
	flashing	→ not assigned to a controller (tactile only)
red battery LED	continuously	→ battery low or discharged
infrared LEDs		IR LEDs for tracking
On/Off switch		activates / deactivates the hand target
L/H switch		select the IR LED brightness (low / high)
set 1/2 switch		select the target geometry (i.e. 2=second pair)
colored marking front-side		indicates the correct thimble set (red=right hand or blue=left hand)
letters (L and R) embossed bottom-side		indicates whether the hand target is dedicated for the red=right hand or blue=left hand
sticker bottom-side		showing the type and serial number of the device
infrared sync receiver		receiver for the coded IR flash (i.e. synchronization signal)

Table 5.7: Description of *FINGERTRACKING2* and *FINGERTRACKING2 Tactile* hand target

Set 1/2 switch To use two pairs of *FINGERTRACKING2* or *FINGERTRACKING2 Tactile* sets simultaneously, configure one to Set 1 and the other to Set 2.



Select the Set 1 or 2 configuration of the *FINGERTRACKING2* or *FINGERTRACKING2 Tactile* handtargets during first-time installation only. Do not change the setting during routine operation or tracking will fail.

Inserting the battery The *FINGERTRACKING2* and *FINGERTRACKING2 Tactile* hardware uses standard micro-AAA batteries. A set of batteries and a charger are provided with each set. Open the battery compartment and insert the batteries (see figure 5.37 on page 95). Close the lid of the battery compartment afterwards.



Insert batteries in the indicated polarity

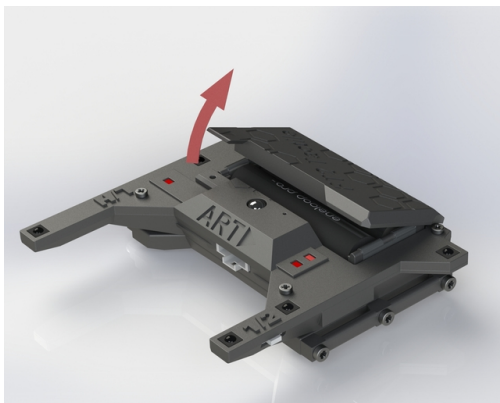

(a) Step1

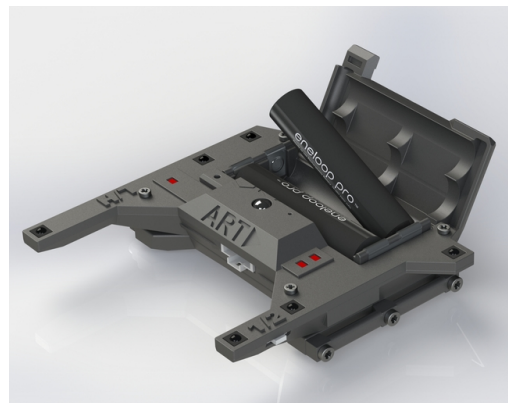

(b) Step2

Figure 5.37: Inserting the battery (*FINGERTRACKING2* and *FINGERTRACKING2 Tactile*)

Connecting the finger thimble set to the hand target unit Just plug in the connector of the finger thimble sets into the hand target as shown in figure 5.38 on page 96. Please connect the correct thimble set to the corresponding hand target by verifying the colored markings. Then apply the finger thimbles to your thumb and fingers observing the order of the flexible wires shown in figure 5.35 on page 93.



Watch out for the colored marking of the thimble set! red=right hand, blue=left hand

Radio module (*FINGERTRACKING2 Tactile* only) *FINGERTRACKING2 Tactile* uses a radio module in the 2.4GHz band. This band is standardized internationally and can be used without a license. Range with line of sight is more than 10m but can be reduced when passing material, e.g. projection screens.



(a) Plugging in the connector

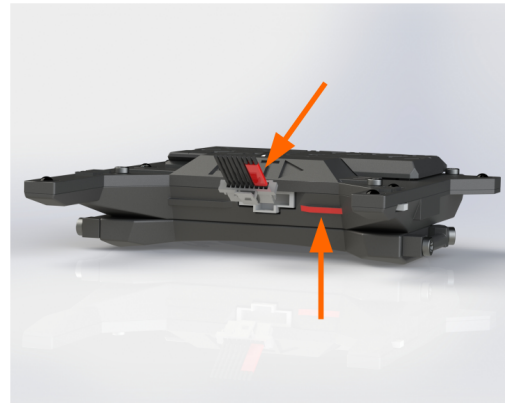

(b) Colored marking of thimble set and handheld red=right hand, blue=left hand

Figure 5.38: Connecting the finger thimble connector with the hand target (*FINGERTRACKING2* and *FINGERTRACKING2 Tactile*)

5.8.3.2 Finger thimble sets *FINGERTRACKING2*

FINGERTRACKING2 can be ordered as a 3-finger AR or a 5-finger AR version, while *FINGERTRACKING2 Tactile* can be ordered as a 3-finger AR version only. Tactile thimbles additionally feature a vibrational motor to induce feedback.

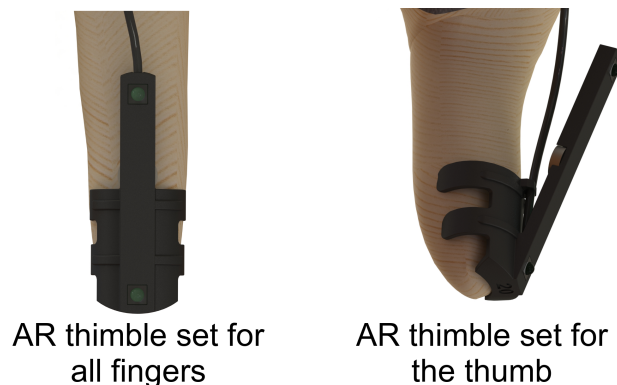

AR thimble set for all fingers

AR thimble set for the thumb

Figure 5.39: Comparison of the finger thimble sets (AR) for *FINGERTRACKING2* (vibrational motor on *FINGERTRACKING2 Tactile* only)

FINGERTRACKING2 and *FINGERTRACKING2 Tactile* are delivered with three pairs of thimble sets with different sizes (see table 5.8 on page 97).

5.8.3.3 Wireless synchronization

The black sphere on top of the *FINGERTRACKING2* & *FINGERTRACKING2 Tactile* hand targets is a receiver for the coded IR flash (i.e. modulated infrared signal) which is used for synchronization (see figure 5.36 on page 94). This coded signal can be generated by all *ARTTRACK* cameras (*DTRACK3* is required). In some cases (discontinued products)

Finger size	Scope of delivery
Extra-Small-sized fingers (optional)	Diameters of 14mm (thumb) and 11-12mm (other fingers)
Small-sized fingers	Diameters of 16mm (thumb) and 13-14mm (other fingers)
Medium-sized fingers	Diameters of 18mm (thumb) and 15-16mm (other fingers)
Large-sized fingers	Diameters of 20mm (thumb) and 17-18mm (other fingers)

Table 5.8: Description of the finger thimbles *FINGERTRACKING2* and *FINGERTRACKING2 Tactile*

an additional external flash is necessary. Please contact your **ART** representative.

The modulated flash is adjustable in *DTRACK3* → *Hardware* → *Cameras*. Tick the checkbox 'modulated flash' or select an individual camera which is in syncgroup # 1 from the list. Press *OK* to apply the changed settings. Please refer to the *DTRACK3 User's Guide* → *Camera Settings*.

Active targets need synchronization in order to make sure that the IR LEDs are flashing at the proper time. To ensure wireless synchronization the following points should be observed:



- **All cameras with activated modulated flash have to be assigned to syncgroup #1 (default for SMARTTRACK3 & SMARTTRACK3/M) ! ARTTRACK6/M , ARTTRACK5 , ARTTRACK5/C , TRACKPACK/E , & TRACKPACK systems may be configured via software. ARTTRACK2 & ARTTRACK3 have to be connected to 'OUT1' on the controller's Synccard (refer to paragraph Sync group in the DTRACK3 User's Guide → Camera Settings.**
- **Note that the synchronization will not work near plasma screens.**
- **If two or more tracking systems using wireless synchronization are in the same room, then external synchronization of the systems might be necessary (e.g. at tradeshow).**

5.8.3.4 Battery charger

A battery charger is supplied with all *FINGERTRACKING2* and *FINGERTRACKING2 Tactile* devices and must be used for charging the batteries.

Insert the batteries in the corresponding slots and plug the charger into a power socket. Charging will start automatically. When the batteries are fully charged all LEDs adjacent to the corresponding slot will light up. Please refer to the manual of the charger for further details.

5.8.3.5 Data output

The output data consists of:

- position and orientation of the hand,
- number of the tracked fingers and a value to distinguish between left and right hand
- position and orientation of the outermost phalanxes; the radius of the finger tip to identify its position and orientation
- angles between the single phalanxes and their respective lengths

Please refer to *DTRACK3 Programmer's Guide* → *Output of Measurement Data via Ethernet* for more information about the format of the output data.

5.8.3.6 Tactile control

Additionally *FINGERTRACKING2 Tactile* offers a list of control commands to address the tactile feedback within your application. These consist of:

- the *Hand ID* and *Finger ID* to address each finger of each hand individually
- a value denoting the strength of the feedback

Please refer to *DTRACK3 Programmer's Guide* → *Input of Control Data via Ethernet* for details.

5.8.4 Measurement Tool

Introduction The Measurement Tool is an add-on to *ART* tracking systems and is unlocked in *DTRACK3* by entering the corresponding license code. Please contact your *ART* representative. Please refer to the *DTRACK3 User's Guide* → *Basic Configuration* for details how to upgrade your system.

Description The *ART* Measurement Tool is a pointing device for measurement applications. In this specialized field it is very important to measure positions of points with high accuracy. Therefore the Measurement Tool is equipped with a measurement tip which can be measured with the optical tracking system.

The pointing device carries a target specifically developed for optimal tracking quality using two cameras. The best results are achieved when the pointing device is facing the cameras as shown in figure 5.40 on page 99 (i.e. all markers are oriented towards the cameras). Typically, the position of the tool's tip is measured in the room coordinate system which was set up during room calibration.



Figure 5.40: Measurement Tool

Optionally, the **ART** Measurement Tool can calculate the position relative to a reference body. This way the Measurement Tool is measuring distances to the origin of the reference body coordinate system and not to the origin which was defined during room calibration.

5.8.4.1 Data output

The output data consists of:

- position and orientation of the tool's tip,
- number of the Measurement Tool ,
- rotation matrix of the target.

Please refer to ***DTRACK3 Programmer's Guide*** → *Output of Measurement Data via Ethernet* for more information about the format of the output data.

5.9 Discontinued hardware

5.9.1 Mounting the cameras

5.9.1.1 Mounting the *ARTTRACK2* and *ARTTRACK3* (discontinued)

The ceiling suspension for the *ART* cameras can be attached on both bottom and top side of the camera. Attach the carrier with the T-piece pointing to the back of the camera in a similar way to figure 5.9 on page 50. Note, the threaded rod is already connected to the carrier in figure 5.9.



To attach the T-piece on a *ARTTRACK2* remove the screws from the holes 1 and 2 first.



It is recommended to install the power supply for the *ARTTRACK2* and *ARTTRACK3* cameras in a place that enables you to switch the equipment off by a mains switch. This way the cameras can be easily turned off and on without changing their positions.



For thermal reasons the fan always has to be on the top side of the *ARTTRACK2* camera. This means, if the camera is mounted on a ceiling the carrier and the T-piece must be mounted on top (fan side). If it is to be mounted standing on the floor the carrier and the T-piece must be on the bottom side of the housing.

5.9.1.2 Mounting the *TRACKPACK* (discontinued)

The ceiling suspension for the *ART* cameras can be attached on both bottom and top side of the camera. Attach the carrier with the T-piece pointing to the back of the camera in a similar way to figure 5.9 on page 50. Note, the threaded rod is already connected to the carrier in figure 5.9.



Please keep the distance between the cameras in a range of 1 to 2 metres. Please contact *ART* for more information.

5.9.1.3 Mounting the *TRACKPACK/C* (discontinued)

The ceiling suspension can be attached to the *TRACKPACK/C* camera as shown in figure 5.41 on page 101.



Please keep the distance between the cameras in a range of 2 to 3 metres. Please contact *ART* for more information.

5.9.1.4 Mounting the *SMARTTRACK2* (discontinued)

The ceiling suspension can be attached to the *SMARTTRACK2* on both bottom and top side of the housing. Attach the carrier with the T-piece pointing to the back of the *SMARTTRACK2* similar to figure 5.11 on page 51).

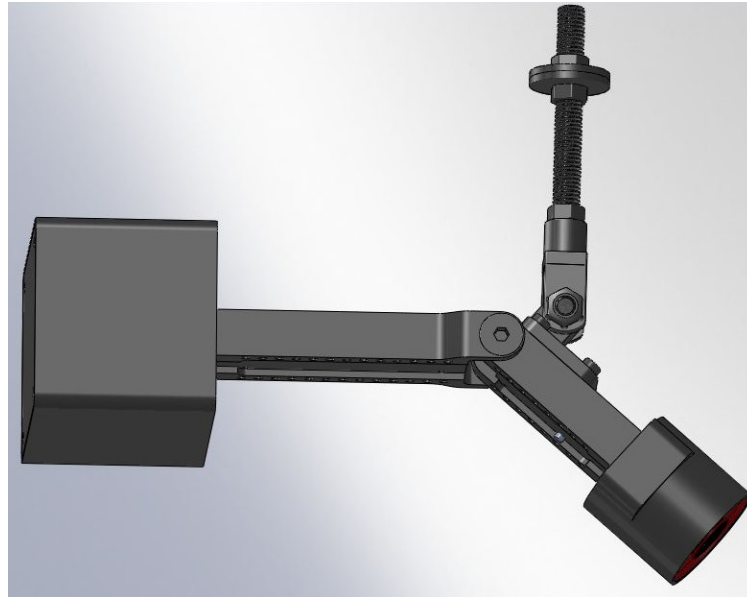

Figure 5.41: Camera *TRACKPACK/C* with attached ceiling suspension



It is recommended to install the power supply for the *SMART-TRACK2* in a place that enables you to switch the equipment off by a mains switch. This way the *SMARTTRACK2* can be easily turned off and on without changing its position.

5.9.2 Installation of the *ARTTRACK* Controller (discontinued)

The following list introduces the ports of the *ARTTRACK* Controller with *Synccard2* :

- internal Ethernet switch:
the cameras have to be plugged in here. In larger systems, please connect the external switch to any of these ports.
- external Ethernet switch:
the Allied Telesis AT-FS708 is an eco friendly switch which is designed to minimize power consumption (typical 3.5W) through the use of a high efficiency power supply and a low power chipset. It features an overnight mode (i.e. reduction in power during after-work hours) as well as other power saving features.
Please refer to the Allied Telesis Installation Guide before connecting the power source.
- ***ART Synccard2*** :
 - '*ExtIn*':
Please plug in the external source (TTL or video signal) for synchronization here. For configuration refer to chapter 5.5 on page 65. In cascaded systems please connect the external source to the master controller only.
 - '*Out1-3*':
These ports are used as synchronization outputs (video signal) and are char-

acterized by their respective time delay related to syncgroup #1 on 'Out1'.

- * 'Out1':
Defines syncgroup #1. The three different syncgroups are characterized by their time delay related to syncgroup #1. At least one camera has to be connected here if you are using active targets (e.g. **Fingertracking**, **Flystick3**). Refer to chapter 5.8.3 on page 92 for more information.
- * 'Out2':
Defines syncgroup #2. The time delay related to syncgroup #1 is 480 μ s.
- * 'Out3':
Defines syncgroup #3. The time delay related to syncgroup #1 is 960 μ s.

For cascaded systems please connect 'Out1' to 'ExtIn' of a slave controller (see chapter 5.6 on page 66).

- 'USB port':
Please plug in all USB based peripheral devices here: e.g. **RadioTransceiver2/3** for communication with **Flystick2/2+/3** (refer to chapter 4.4.2 on page 34), Trivisio wireless transceivers and Yost Labs wired inertial sensors (refer to **DTRACK3 User's Guide** → *Hardware* → *Inertial Sensors*). You can also plug-in a USB pen drive for accessing the **ART** Controller without the **DTRACK3** frontend (refer to **DTRACK3 User's Guide** → *Connecting to the controller*).
- 'Ethernet port':
Please connect the **ARTTRACK** controller to your local network using a twisted pair Cat 5 cable.
- 'Power inlet':
Please connect to mains.

Connecting cameras - data Mount the cameras at the desired position before connecting the cables. The controller is equipped with an internal switch (100 Base-TX) which serves for the connection to the cameras (suitable for small systems, i.e. ≤ 4 cameras). The **ARTTRACK** cameras have to be connected via twisted pair cables (min. Cat 5, max. length 100 m) to the internal Ethernet switch of the controller. Larger systems (i.e. > 4 cameras) have to be equipped with an external switch which itself must be connected to any port of the internal switch of the controller.



Older switches sometimes do have uplink ports which are not suitable for connecting to the camera. Only use the normal ports of the switch.

The camera IP addresses are predefined - changes by the user are not possible:



- IP address: 172.28.X.X
- subnet mask: 255.255.0.0

Connecting cameras - synchronisation The controller is equipped with a PCI card for synchronization of the IR cameras (*ART Synccard2*). When connecting the synchronization cables it is important to correctly chain the cameras on the sync cable (see chapter 6.2 on page 119). There must be one continuous signal line from the BNC connector of the *Synccard2* to the 75Ω terminating resistor, with the cameras inserted to the line by tee connectors. Do not extend the connection between the tee-connector and the camera nor branch the signal line (star wiring).

Typically all cameras are connected to the syncgroup #1 ('OUT1') of the *Synccard2*. If the cameras have to be grouped into different syncgroups, in order to avoid mutual blinding, two or three BNC chains are used at the sync outputs #1 and #2 or #1, #2 and #3 of the *ART Synccard2* respectively. The settings of the *Synccard2* are defined by software *DTRACK3*.

Connection to local network LAN The controller uses the single Ethernet port (100 Base-TX) for data output to the remote PC or to any PC within the local network. Please refer to chapter 5.4 on page 62 for more information.

External synchronization Any *ARTTRACK* system controller can be synchronized with an external source. Please refer to chapter 5.5 on page 65 for more information.

5.9.3 Installation of the *TRACKPACK* Controller (discontinued)

The following list introduces the ports of the *TRACKPACK* Controller:

- ***ART SynccardTP*** :
The syncgroups for *TRACKPACK* systems can be configured in the *DTRACK3* front-end software. Please refer to *DTRACK3 User's Guide* → *Hardware* → *Cameras*.
 - '*ExtIn*':
Please plug in the external source (TTL or video signal) for synchronization here. For configuration refer to chapter 5.5 on page 65.
 - '*Output*':
The cameras have to be plugged in to the RJ45 connectors. Synchronization and power is supplied with this connection.
- '*Firewire*':
Please connect the *TRACKPACK* cameras with the controller using the delivered Firewire cables.

- **'USB port':**
Please plug in all USB based peripheral devices here: e.g. *RadioTransceiver2/3* for communication with *Flystick2/2+/3* (refer to chapter 4.4.2 on page 34), Trivisio wireless transceivers and Yost Labs wired inertial sensors (refer to *DTRACK3 User's Guide* → *Hardware* → *Inertial Sensors*). You can also plug-in a USB pen drive for accessing the *ART* Controller without the *DTRACK3* frontend (refer to *DTRACK3 User's Guide* → *Connecting to the controller*).
- **'Ethernet port':**
Please connect the *ARTTRACK* controller to your local network using a twisted pair Cat 5 cable.
- **'Power inlet':**
Please connect to mains.

Connecting cameras - data Mount the cameras at the desired position before connecting the cables. The controller is equipped with an internal *'Firewire'* card which serves for the connection to the cameras (suitable for small systems, i.e. ≤ 4 cameras). The *TRACKPACK* cameras have to be connected via *'Firewire'* cables (max. length 10 m) to the internal *'Firewire'* card of the *TRACKPACK* controller.

Connecting cameras - synchronisation & power The controller is equipped with a PCI card for synchronization and powering of the IR cameras (*ART SynccardTP*). Use Cat 5 cables for connecting the cameras with the *SynccardTP*.

Connection to local network LAN The controller uses the single Ethernet port (100 Base-TX) for data output to the remote PC or to any PC within the local network. Please refer to chapter 5.4 on page 62 for more information.

External synchronization Any *TRACKPACK* controller can be synchronized with an external source. Please refer to chapter 5.5 on page 65 for more information. The status of the synchronization is indicated with two LEDs (orange and green) located on the *SynccardTP* of the controller. Depending on the operating condition of the *ART* tracking system the LEDs are triggered respectively. Table 5.9 shows how the LEDs are triggered according to the type of synchronization.



**Be aware of the following property of the *TRACKPACK* system:
The *TRACKPACK* cameras are powered and synchronized via the RJ45 cable!**

5.9.4 Installation of the *SMARTTRACK2* (discontinued)

Ports & Plugs on the *SMARTTRACK2* The following list gives a short overview of all ports accessible to the user. (see figure 5.42 on 105):

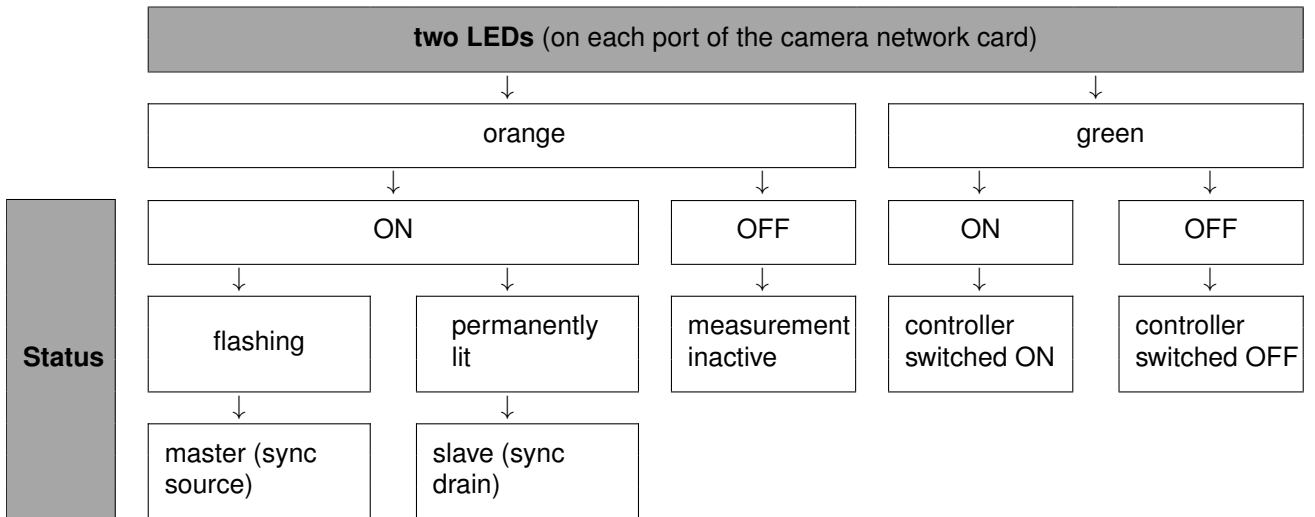

Table 5.9: Description of the LEDs on the back of the *TRACKPACK* Controller

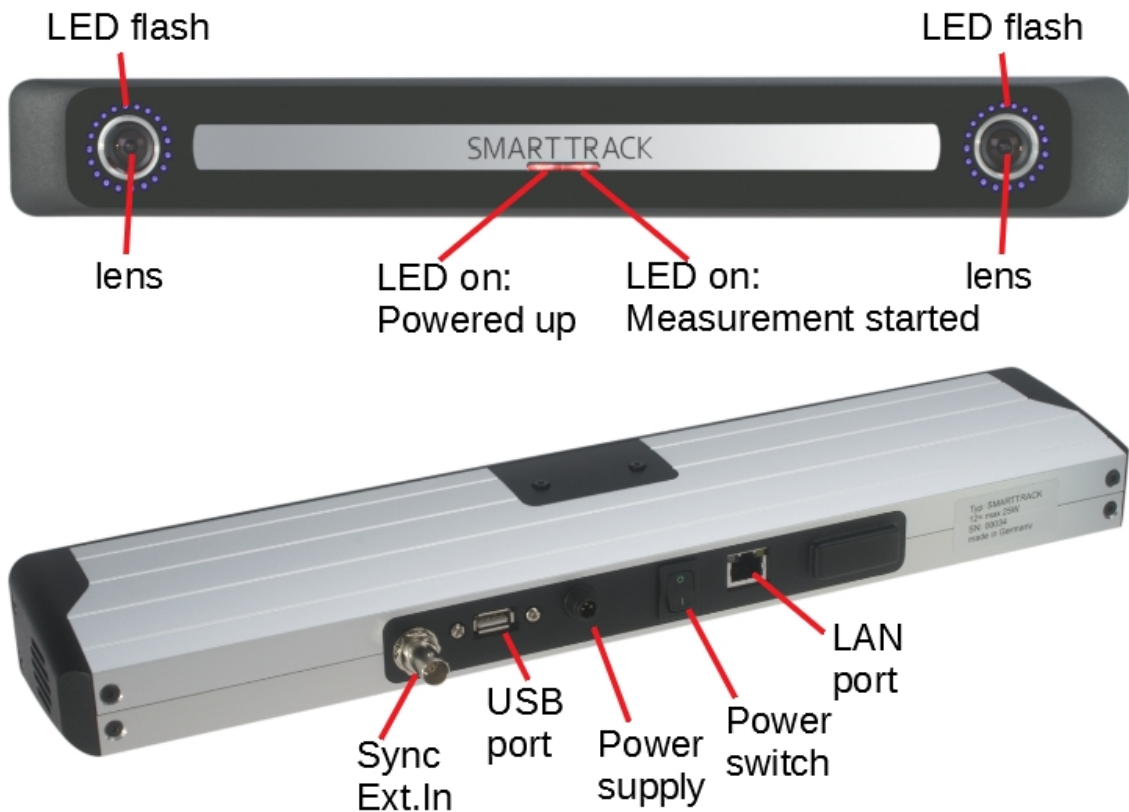

Figure 5.42: *SMARTTRACK2* - Front & Back view

- 'Sync ExtIn': Please plug in the external source (TTL or video signal) for synchronization here. For configuration refer to chapter 5.5 on page 65.

- **'USB port':**
Please plug in USB based peripheral devices here: e.g. Trivisio wireless transceivers and Yost Labs wired inertial sensors (refer to *DTRACK3 User's Guide* → *Hardware* → *Inertial Sensors*). You can also plug-in a USB pen drive for accessing the *SMARTTRACK2* without the *DTRACK3* frontend (refer to *DTRACK3 User's Guide* → *Connecting to the controller*).
- **'Power supply':**
Please connect the *SMARTTRACK2* to the provided power supply.
- **'Switch':**
Flip the power switch to 'I' to start the *SMARTTRACK2*.
- **'LAN network port':**
Please connect the *SMARTTRACK2* to your local network using a twisted pair Cat 5 cable.



The USB port is compliant to USB 2.0 (5 V max. 500 mA)



A passive USB hub is required when attaching multiple / high-power USB devices. Do not use an externally powered USB hub !

Connection to local network LAN The integrated controller uses the *'LAN network port'* (100 Base-TX) for data output to the remote PC or to any PC within the local network. Please refer to chapter 5.4 on page 62 for more information.

External synchronization The *SMARTTRACK2* can be synchronized with an external source. Please refer to chapter 5.5 on page 65 for more information.

5.9.5 Flystick3 (discontinued)

Description The *Flystick3* is a lightweight input device for *ART* infrared optical tracking systems.

It is equipped with an active¹ or passive target, a trigger, three buttons and an analogue joystick for wireless interaction in a virtual environment (see figure 5.43 on page 107). Synchronization of the active *Flystick3* (discontinued) is provided wirelessly with a modulated flash by one camera.

Input transactions (buttons & joystick) are transmitted via low-rate wireless personal area network (IEEE 802.15.4) to the controller and added to the 6DOF tracking result of the *Flystick2/2+/3* bodies. Tracking and interaction data are then transmitted to the application via Ethernet.



The radio transmission and the active target are switched off after 15 minutes without usage. Press any button to reactivate the *Flystick3* and, therefore, tracking.

¹discontinued

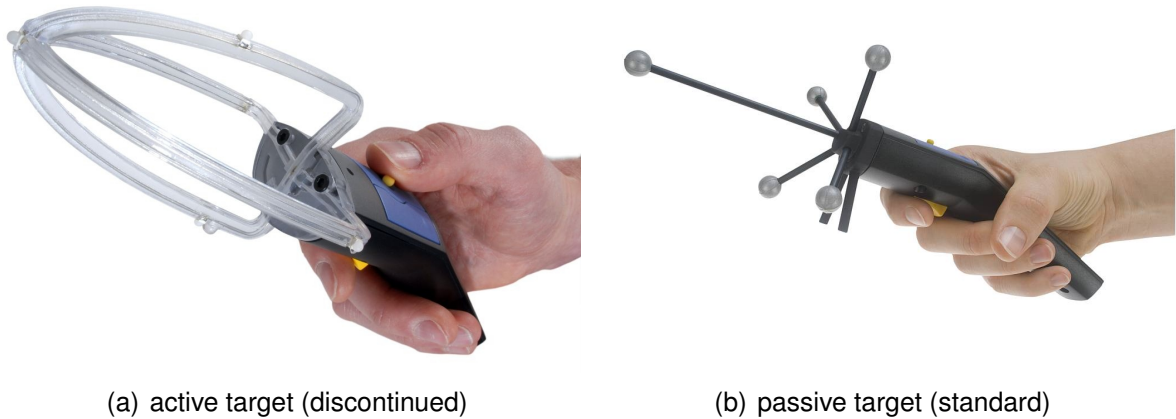

Figure 5.43: *Flystick3*

5.9.5.1 Control elements

The numbering sequence of the buttons is as follows (see also figure 5.44 on page 107):

- # 1 trigger
- # 2 - # 4 blue buttons, right to left

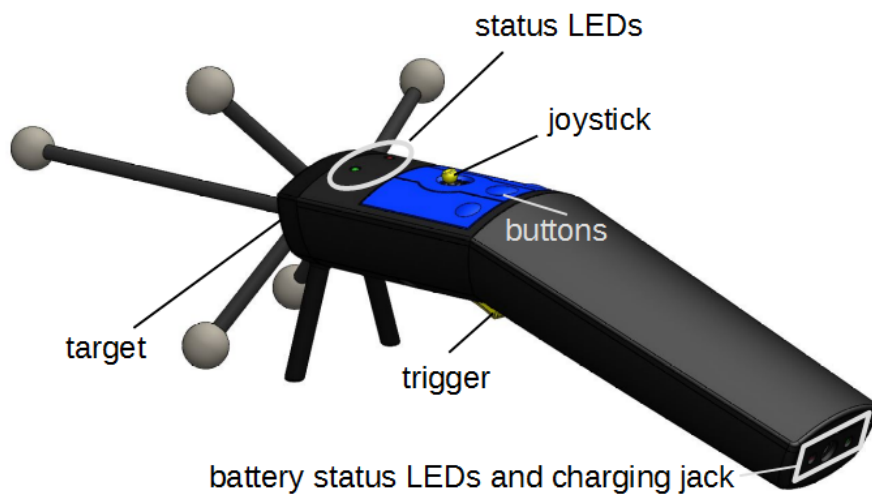

Figure 5.44: *Flystick3* control elements

The *Flystick3* device provides all functions (buttons, trigger and joystick) simultaneously. In neutral position the joystick transmits $x=0$, $y=0$.

- Moving left creates negative x values, moving right positive x values.
- Moving down creates negative y values, moving up positive y values.
- Full extension into any direction creates values of 1.0 or -1.0.

Top View	Event	Description
status LEDs	green pulse	button pressed or joystick position successfully transmitted
	yellow pulse	button pressed or joystick position could not be transmitted
	yellow (and green) flickering	low battery, recharge soon
trigger, button and joystick		press the trigger or any button to invoke an interaction which can be defined in the user application (e.g. drag objects while button trigger pressed, open a menu dialogue, ...)

Table 5.10: Description of the *Flystick3* control elements

In case you need to carry out a factory reset for the *Flystick3* you will find the reset button just on top of the charging jack. You may use a paper clip to press the reset button.

5.9.5.2 Data output

The output data consists of:

- position and orientation of the *Flystick*,
- status of buttons and joystick,
- number of used *Flystick2/2+/3* .

Please refer to *DTRACK3 Programmer's Guide* → *Output of Measurement Data via Ethernet* for more information about the format of the output data.

5.9.5.3 Battery pack

The *Flystick3* contains a battery pack inside the device.

Replacing the battery For replacing the battery of the *Flystick3* , you have to take off the back cover first. To this end, loosen the four screws using the 2.5mm hexagon key and remove the back cover.

Remove the old battery and insert the replacement correctly within the cut-out.

Apply the back cover again and tighten the screws carefully.



Dispose used batteries according to your governmental regulations.



Risk of explosion if battery is replaced by an incorrect type!

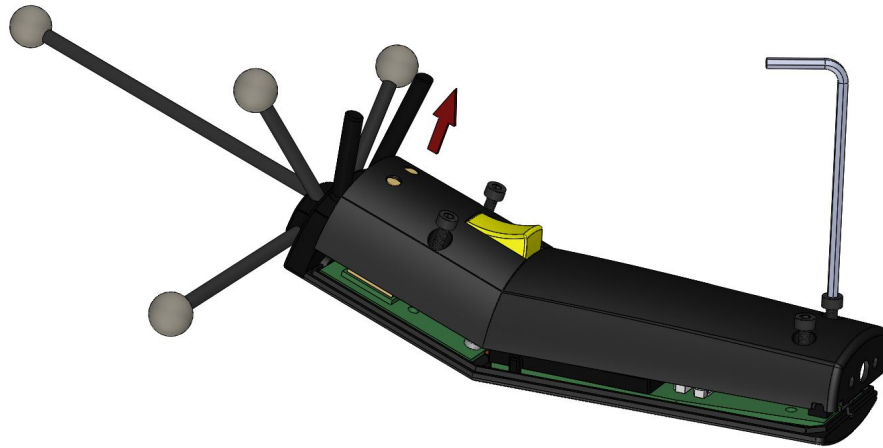

Figure 5.45: Open the battery compartment of *Flystick3*

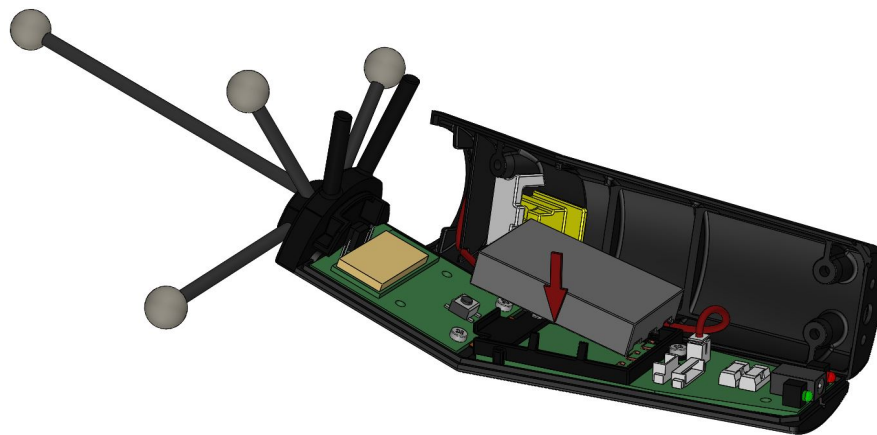

Figure 5.46: Insert new battery in *Flystick3*

5.9.5.4 Battery charger

A battery charger is supplied with the delivered *Flystick3* and must be used for charging the batteries. As soon as the battery pack is connected to the charger, the red LED ("Charge") is switched on. Once the battery pack is fully charged the charger switches off the "Charge" LED, the green "Ready" LED is switched on. Now, the battery pack may be used again.



Note: During the charging process you may continue using your *Flystick3*



Use the supplied charger authorized by ART only ! Do not charge for > 24 h.

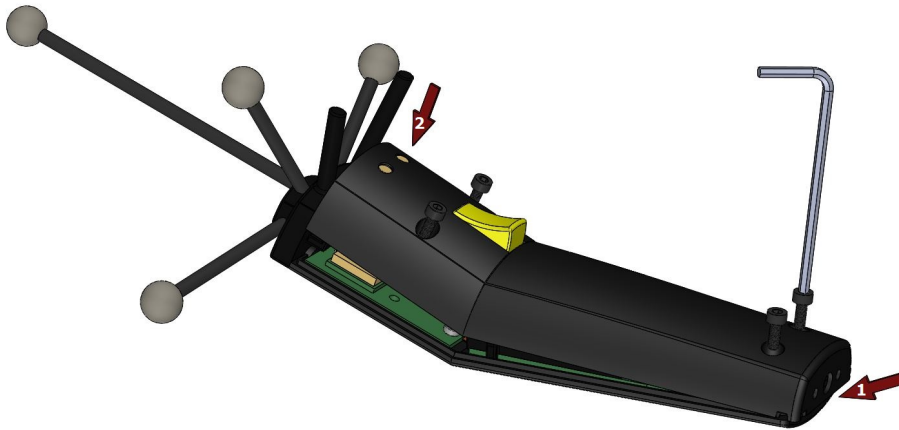

Figure 5.47: Close the battery compartment of *Flystick3*



Green LED permanently on / Red LED flashing at the same time: Error during charging ! The battery may be defective or it has been inserted the wrong way. Disconnect the battery charger immediately !

5.9.5.5 Radio module

The *Flystick3* uses a low-rate wireless personal area network (IEEE 802.15.4) radio module in the 2.4GHz band. This band is standardized internationally and can be used without a license. Range with line of sight is more than 7m but can be reduced when the signal penetrates material, e.g. projection screens.

5.9.5.6 Wireless synchronization (active *Flystick3* discontinued)

The receiver for the modulated infrared signal which is used for synchronization is located in the middle of the joint between transparent target and handpiece. This coded signal can be generated by all *ARTTRACK* cameras (*DTRACK3* is required). In some cases (discontinued products) an additional external flash is necessary. Please contact your *ART* representative.

The modulated flash is adjustable in *DTRACK3* → *Hardware* → *Cameras*. Tick the checkbox 'modulated flash' or select an individual camera which is in syncgroup # 1 from the list. Press *OK* to apply the changed settings. Please refer to the *DTRACK3 User's Guide* → *Camera Settings*.



If your system is configured with more than one syncgroup it is necessary to configure the *Flystick3* as follows: Go to *Tracking* → *Flystick* and increase the number of 'Syncgroups' according to the number of syncgroups used to set up the system.

Active targets need synchronization in order to make sure that the IR LEDs are flashing at the proper time. To ensure wireless synchronization the following points should be observed:



- All cameras with activated modulated flash have to be assigned to syncgroup #1 (default for *SMARTTRACK3* & *SMARTTRACK3/M*) ! *ARTTRACK6/M* , *ARTTRACK5* , *ARTTRACK5/C* , *TRACKPACK/E* , & *TRACKPACK* systems may be configured via software. *ARTTRACK2* & *ARTTRACK3* have to be connected to 'OUT1' on the controller's *Synccard* (refer to paragraph Sync group in the *DTRACK3 User's Guide* → *Camera Settings*).
- Note that the synchronization will not work near plasma screens.
- If two or more tracking systems using wireless synchronization are in the same room, then external synchronization of the systems might be necessary (e.g. at tradeshows).

5.9.6 Fingertracking (discontinued)

Description The *Fingertracking* (discontinued) system is a device that measures the position of the hand and the finger bones. To achieve this, a 6DOF target is attached to the palm of the hand and thimbles with 1 or 2 markers are worn on the measured finger tips (see figure 5.48 on page 112). All other information is derived from the kinematics of the hand, which are measured by a short calibration process.

The active markers for the finger tips are sequentially addressed to allow the tracking system to discriminate between the single fingers. Therefore the update rate of the fingers is only a fraction of the tracking frequency for the hand target, i.e. one-third for 3 thimbles and one-fifth for 5 finger tracking.



Fingertracking is not available for *SMARTTRACK2/3/M*



The tracking frequency for each finger is dependent on the number of finger thimbles, i.e. using 60 Hz tracking frequency this corresponds to 12 Hz for each finger (*Fingertracking 5 finger thimbles*) or 20 Hz (*Fingertracking 3 finger thimbles*)

General specifications All *Fingertracking* devices consist of:

- a hand target unit for fixing on the back of the hand with IR LEDs (active markers) for tracking (see figures 5.49 on page 112).
- three or five finger thimbles (a fixture for the finger tip), each featuring IR LEDs connected via flexible wires (see figure 5.52 on page 115)
- wireless synchronization using a receiver for a coded IR flash (modulated flash)
- rechargeable batteries and a battery charger



(a) *Fingertracking* device with three active finger markers

(b) *Fingertracking* device with five active finger markers

Figure 5.48: All *Fingertracking* (discontinued) devices

5.9.6.1 *Fingertracking* Hand Targets

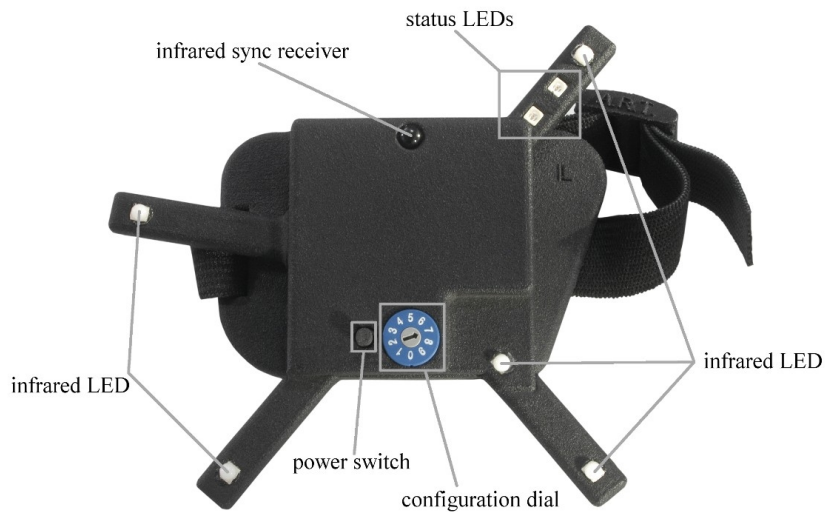

Figure 5.49: *Fingertracking* hand target (discontinued)

On/off button Pressing the small black button next to the configuration dial activates or deactivates the target (please refer to figure 5.49 on page 112). After turning on the hand target unit, the status LEDs light up according to table 5.11 on page 113. When

Top View	Event	Description
status LEDs	green LED continuously	→ synchronization received and tracking
	red LED continuously	→ no synchronization received
infrared LEDs	red and green LED flashing	→ battery low or discharged
	power button	IR LEDs for tracking activate or deactivate the <i>Fingertracking</i> hand target
configuration dial		select the LED brightness and the number of fingers
letters (L and R)		indicate whether the hand target is dedicated for the left or right hand
infrared sync receiver		receiver for the coded IR flash (i.e. synchronization signal)

Table 5.11: Description of the hand target (*Fingertracking* discontinued)

deactivating the hand target all IR LEDs are switched off and the microcontroller is put into sleep mode. Therefore a certain minimal power consumption is inevitable.



When the *Fingertracking* is not used for a longer period of time (i.e. more than a week) the batteries should be removed from the hand target to prevent deep discharge - Risk of damage !

Configuration dial The configuration dial is used to select the LED brightness and the number of fingers used in the setup (please refer to figure 5.49 on page 112). A detailed description of the configuration dial may be found in table 5.12 on page 113.

ID	no. of sync finger	Flash time [μ s]
0	3	25
1	3	50
2	3	75
3	3	100
4	5	25
5	5	50
6	5	75
7	5	100
8	-	-
9	-	-

Table 5.12: Description of the configuration dial (*Fingertracking* discontinued)

Note For serial numbers < 100 the LED brightness and the number of flash groups is configured differently:

- positions 0 to 3: one syncgroup

- position 4 to 7: three syncgroups
- position 8 to 9: unused

Connecting the finger thimble set with the hand target Just plug in the connector of the finger thimble sets into the hand target as shown in figure 5.50 on page 114. Then apply the finger thimbles to your thumb and fingers observing the order of the flexible wires shown in figure 5.48a+b on page 112.

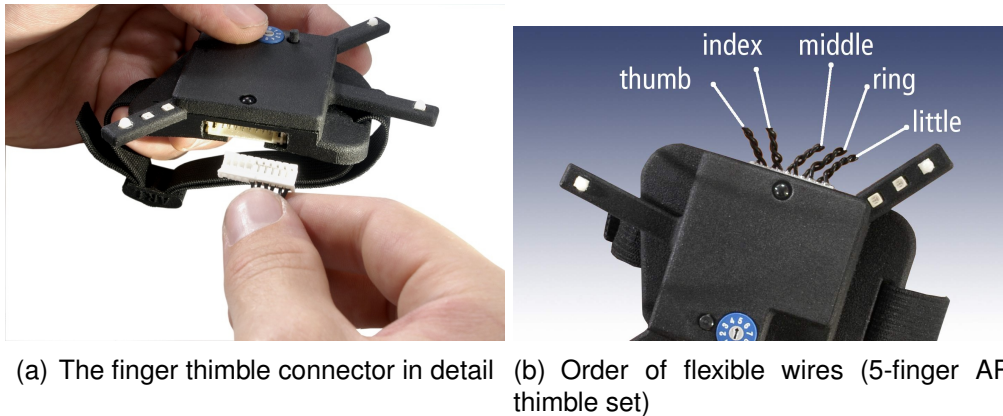

Figure 5.50: Connecting the finger thimble set to the hand unit (*Fingertracking*)

Inserting the battery The *Fingertracking* hardware uses standard CAN NB-4L batteries. Two batteries and a charger are provided with each *Fingertracking* set. Squeeze the battery in with the contact side first and then gently press the battery into the compartment until it snaps in (see figure 5.51 on page 114).

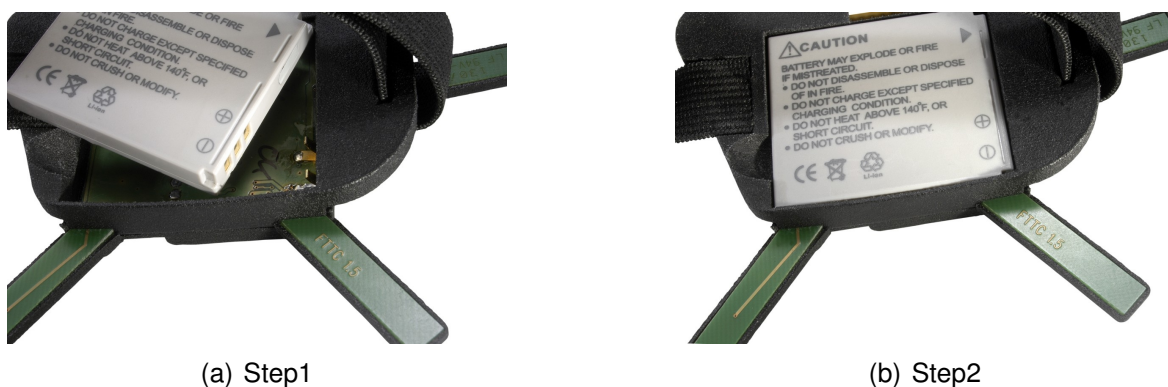

Figure 5.51: Inserting the battery (*Fingertracking* discontinued)

5.9.6.2 Finger thimble sets *Fingertracking*

Fingertracking can be ordered as a 3-finger VR, a 3-finger AR or a 5-finger AR version. The difference between the AR and VR versions is the position of the LED on the finger thimble: for the VR version the LED is placed on the tip of the thimble, whilst for the AR version it is placed on top of the thimble (see figure 5.52 on page 115).



Figure 5.52: Comparison of the finger thimble sets (VR, AR) for *Fingertracking* (discontinued)

Fingertracking is delivered with three pairs of thimble sets with different sizes (see table 5.13 on page 115).

Finger size	Scope of delivery
Small-sized fingers	Diameters of 16mm (thumb) and 13-14mm (other fingers)
Medium-sized fingers	Diameters of 18mm (thumb) and 15-16mm (other fingers)
Large-sized fingers	Diameters of 20mm (thumb) and 17-18mm (other fingers)

Table 5.13: Description of the finger thimbles *Fingertracking* (discontinued)

5.9.6.3 Wireless synchronization

The black sphere on top of the *Fingertracking* hand targets is a receiver for the coded IR flash (i.e. modulated infrared signal) which is used for synchronization (see figure 5.49 on page 112). This coded signal can be generated by all **ARTTRACK** cameras (**DTRACK3** is required). In some cases (discontinued products) an additional external flash is necessary. Please contact your **ART** representative.

The modulated flash is adjustable in **DTRACK3** → *Hardware* → *Cameras*. Tick the checkbox 'modulated flash' or select an individual camera which is in syncgroup # 1 from the list. Press *OK* to apply the changed settings. Please refer to the **DTRACK3 User's Guide** → *Camera Settings*.

Active targets need synchronization in order to make sure that the IR LEDs are flashing at the proper time. To ensure wireless synchronization the following points should be observed:



- All cameras with activated modulated flash have to be assigned to syncgroup #1 (default for *SMARTTRACK3* & *SMARTTRACK3/M*) ! *ARTTRACK6/M* , *ARTTRACK5* , *ARTTRACK5/C* , *TRACKPACK/E* , & *TRACKPACK* systems may be configured via software. *ARTTRACK2* & *ARTTRACK3* have to be connected to 'OUT1' on the controller's *Sync*card (refer to paragraph Sync group in the *DTRACK3 User's Guide* → *Camera Settings*).
- Note that the synchronization will not work near plasma screens.
- If two or more tracking systems using wireless synchronization are in the same room, then external synchronization of the systems might be necessary (e.g. at tradeshows).

5.9.6.4 Battery charger

A battery charger is supplied with all *Fingertracking* devices and must be used for charging the batteries.

When you connect the battery charger to a power socket, the red LED ("Status") is switched on and the green LED ("Charge") starts flashing. As soon as you place the battery correctly in the charger, the "Charge" LED changes its colour to red and stops flashing. Once the battery is fully charged the "Charge" LED changes its colour to green again. Now, the battery may be used.

5.9.6.5 Data output

The output data consists of:

- position and orientation of the hand,
- number of the tracked fingers and a value to distinguish between left and right hand
- position and orientation of the outermost phalanxes; the radius of the finger tip to identify its position and orientation
- angles between the single phalanxes and their respective lengths

Please refer to *DTRACK3 Programmer's Guide* → *Output of Measurement Data via Ethernet* for more information about the format of the output data.

6 Frequently asked questions (FAQ)

Within this FAQ chapter we are offering solutions for easy-to-solve questions that our support encounters from time to time. The questions are grouped into specific topics to make it more convenient for you to find a solution.

In case you do not find a proper solution for your specific problem, please do not hesitate to contact us.

Our goal is to offer the best support possible. Therefore, we ask you to have the system running and that you have internet access when you call us. Additionally we will need details about your system. Please refer to the ***DTRACK3 User's Guide*** → *Menu Help* → *Service* → *Export System Information File* for details how to export a system information file. Please include it in your mail when you contact tech support.

6.1 Cameras

⇒ ***DTRACK3* doesn't recognize the correct number of cameras connected. What can I do?**

- First of all, please check whether cabling is correct.
- Please make sure that all cameras are powered up, indicated by their status LEDs.
- Within ***DTRACK3*** press 'F2' in order to perform a search for new hardware. The cameras should be detected now.
- In case of ***ARTTRACK2*** (discontinued): please make sure that the camera's fan is working. If the fan stops, rising temperatures inside the camera will cause an emergency shutdown of the internal control unit.
- If you are using an external switch, please make sure that no camera is connected to the uplink port and, if applicable, the switch is powered up. Use only compatible switches authorized by ***ART*** and do not tamper with the configuration of managed switches.
- Finally, reboot the cameras, the external switch and the controller.

⇒ **What is the meaning of the red LEDs at the front of the camera?**

They are indicating the status of the camera:

- ***ARTTRACK6/M*** : One LED shows that the camera is powered up and booted.

Whereas, the second LED indicates that the measurement is active. Please refer to figure 4.1 on page 25 for the visualization of the camera.

- **ARTTRACK5** : The lower LED shows that the camera is powered up and booted. Whereas, the upper LED indicates that the measurement is active. In addition to the two status LEDs the 2-digit LED-matrix on the left displays the assigned camera ID (default) and the number of markers in the camera's corresponding field of view (when activated under camera settings). Please refer to figure 4.2 on page 26 for the visualization of the camera.
- **ARTTRACK5/C** : The red LED on the camera body shows that the camera is powered up and booted. Please refer to figures 4.3 on page 27 for the visualization of the cameras.
- **TRACKPACK/E** : The lower left LED show that the camera is powered up and booted. Measurement active is indicated by the lower right LED. Please refer to figure 4.4 on page 28 for a visualization of the camera.
- **ARTTRACK2 / ARTTRACK3** (discontinued): The left LED shows that the camera is powered up and booted. Whereas, the right LED indicates that the measurement is active. In case of an error (e.g. sync loss), the left LED extinguishes and the right LED starts flashing. Please refer to figures 4.11 and 4.12 on pages 35 and 36 for the visualization of the cameras.
- **TRACKPACK** (discontinued): The lower left LED show that the camera is powered up and booted. Measurement active is indicated by the lower right LED. Please refer to figure 4.13 on page 37 for a visualization of the camera.

⇒ **One of my cameras recognizes a reflection which I can't eliminate. What can I do?**

You may enable the suppression of static reflexes within **DTRACK3** . But carefully read the notes in chapter 5.1.2 on page 40.

⇒ **I'd like to expand my system. Is it possible?**

Tracking systems with **ARTTRACK** cameras are expandable up to a total number of 80 cameras. A tracking system with **ARTTRACK1 - ARTTRACK6/M** can be expanded by simply adding additional **ARTTRACK** cameras. Please double-check your current license and the need to purchase a license for more cameras (e.g. 8 or 16) and an additional PoE+ switch.

TRACKPACK/E systems can be expanded up to 16 cameras through means of cascading 2 separate systems. One **ART Controller** or **ART Controller/M** will function as master, while the other works in slave mode. The **TRACKPACK** system (discontinued) can also be extended up to 16 cameras, however more equipment is needed in this case. One separate **ART Controller** or **ART Controller/M** with a license for cascaded systems is

needed to merge the data output streams of the separate stand-alone **TRACKPACK** systems into one single stream.

Please refer to chapter 5.6 on page 66 for more information.

⇒ **Which upgrade possibilities do I have?**

Please refer to table 4.1 on page 31.

6.2 Synchronization

⇒ **Synchronization failed in ARTTRACK6/M & ARTTRACK5 systems**

If you have connected **ARTTRACK6/M**, **ARTTRACK5** or **ARTTRACK5/C** cameras via a PoE+ switch, please check the model of the switch. Some acquirable PoE+ switch models might not be suitable for usage with **ART** cameras. Use only authorized equipment by **ART**. Please refer to table 4.2 on page 33 for more information.

⇒ **Synchronization failed in ARTTRACK6/M, ARTTRACK5 & TRACKPACK/E systems**

Due to the single cable solution, the camera is both powered and synchronized over Ethernet. There is no need to guide or check additional cables dedicated to synchronisation of the cameras. Still hardware issues regarding the controller can arise when using external trigger units, e.g. projectors or graphics cards.

1. Check the cabling (hardware issue):

- Please make sure that the coaxial cables are not damaged.
- Take care of using the correct ports:
 - EXT.In: input of the external synchronization
- **Active stereo:** when using external synchronization (video) the correct cabling would look as follows:

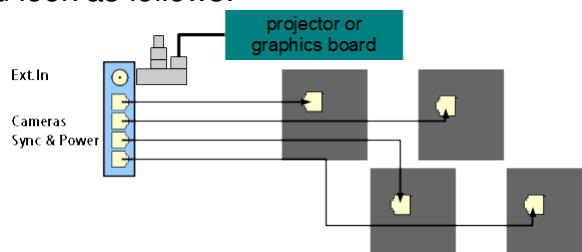

- **Active stereo:** when using external synchronization (TTL) the correct cabling would look as follows:

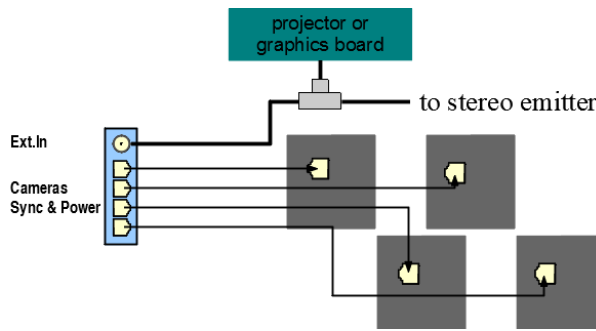

2. Check the synchronization settings (software issue):

- Go to **DTRACK3** → *Hardware* → *Synccard* and double-check the settings (external video signal or TTL) for the **Synccard**.
- In case of external synchronization, please make sure that the synchronization signal is being sent by the external source.

⇒ Synchronization failed in cascaded systems

Cascading means that two or more stand-alone tracking systems are combined to one large system in order to have only one consolidated data output. Consequently the system is divided into one master and up to eight slave controllers. The task of the master is to gather all single data outputs from all slaves and to merge them into one single data output. The **DTRACK3** frontend connects to the master only and allows to configure (e.g. cameras, output, tracking, etc.) the entire tracking system.

1. Check the cabling (hardware issue):

- Please make sure that the coaxial cables are not damaged.
- Take care of using the correct ports:
 - EXT.In: input of the external synchronization (slaves)
 - OUT1: output for synchronization of slave controllers (Do not use OUT2 or OUT3 !)
- Double-check if no extensions between slave controller and terminating resistor have been made.

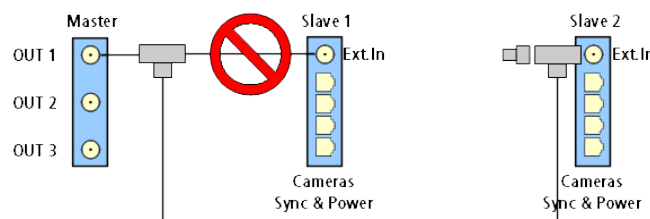

- Double-check if the terminating resistor is missing at the end of the signal line.

6 Frequently asked questions (FAQ)



- Splitting of the synchronization line is not allowed.

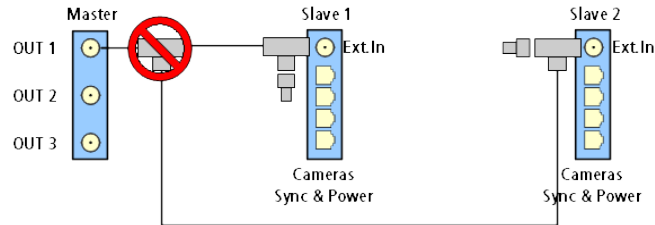

- Do not connect the cable directly to the slave controller.



2. Check the cascade settings (software issue):

- Go to **DTRACK3** → *Hardware* → *Cascaded System* and double-check the attached slave controllers. Please refer to chapter 5.6 on page 66.
- In case of simultaneous external synchronization, please install the synchronization on the master controller according to the instructions for **ARTTRACK6/M**, **ARTTRACK5** and **TRACKPACK/E** systems. Please refer to chapter 5.2.1 on page 52.

⇒ How do I guide the synchronization cables correctly in cascaded systems ?

- When using one **TRACKPACK/E** master and one **TRACKPACK/E** slave controller the correct cabling would look as follows:

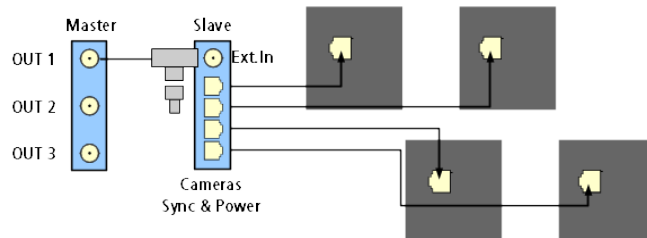

- When using one **ART Controller** or **ART Controller/M** as master and two **TRACKPACK** slave controller the correct cabling would look as follows:

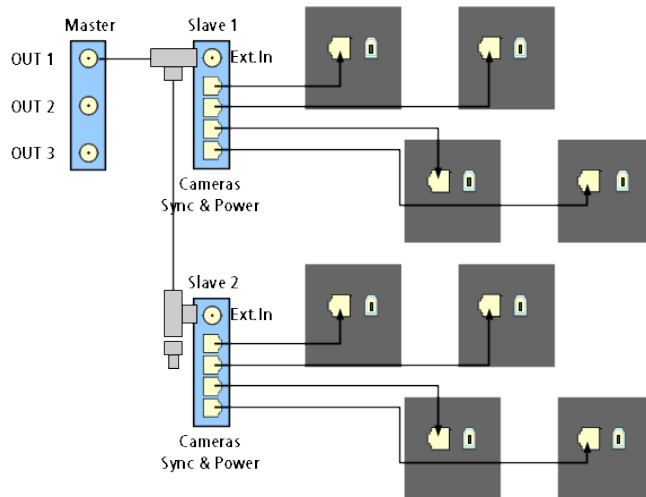

⇒ Synchronization failed in *ARTTRACK 2 & 3* systems (discontinued)

Here we have to distinguish between hardware issues (camera and external synchronization) and software issues:

1. Check the cabling (hardware issue):

- Please make sure that the cables themselves are not damaged.
- Take care of using the correct ports:
 - OUT1 to OUT3: synchronization of the cameras
 - EXT.In: input of the external synchronization
- Double-check if no extensions between camera and terminating resistor have been made.

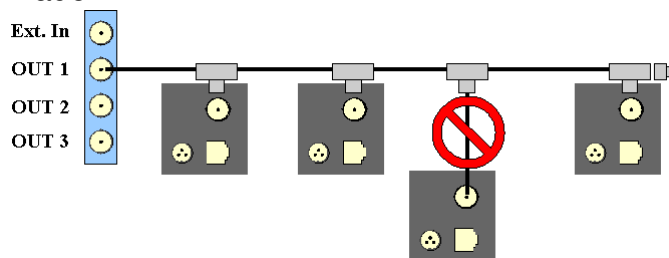

- double-check if the terminating resistor is missing at the end of the signal line.

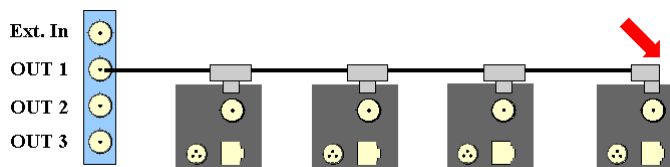

- Splitting of the synchronization line is not allowed.

6 Frequently asked questions (FAQ)

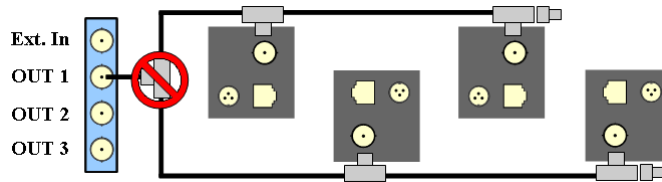

- Do not connect the cable directly to the camera.

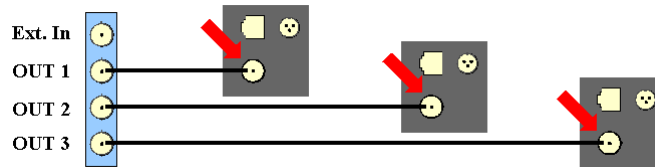

2. Check the synchronization settings (software issue):

- Go to **DTRACK3** → *Hardware* → *Synccard* and double-check the settings (internal or external synchronization) for the synccard.
- In case of external synchronization, please make sure that the synchronization signal is being sent by the external source.

⇒ How do I guide the synchronization cables correctly in **ARTTRACK 2 & 3** systems (discontinued)?

- When using only one syncgroup the correct cabling would look as follows:

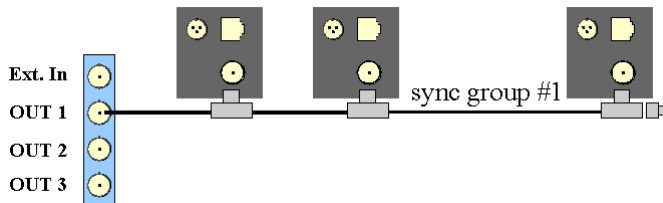

- When using two syncgroups the correct cabling would look as follows:

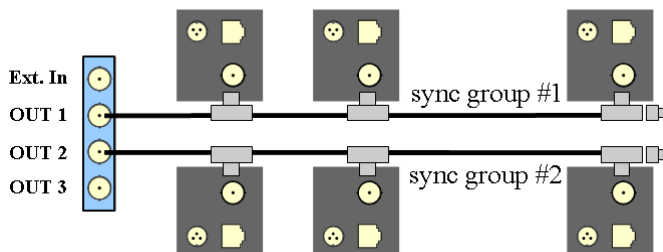

- When using three syncgroups the correct cabling would look as follows:

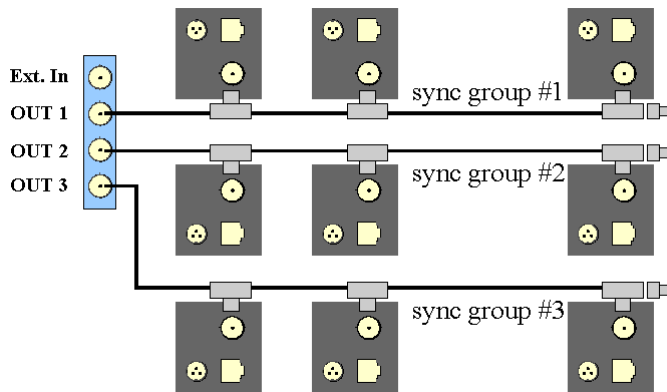

- **Active stereo:** when using external synchronization (video) the correct cabling would look as follows:

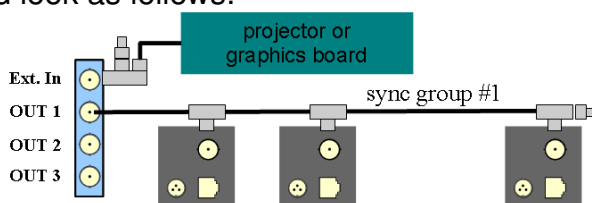

- **Active stereo:** when using external synchronization (TTL) the correct cabling would look as follows:

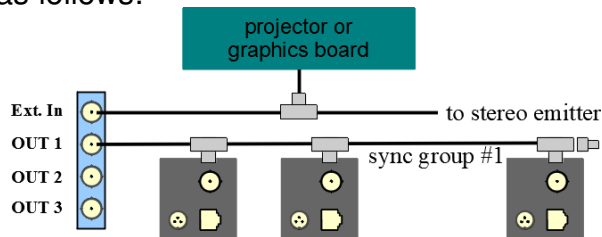

⇒ Synchronization failed in **TRACKPACK** systems (discontinued)

Here we have to distinguish between hardware and software issues:

1. Check the cabling (hardware issue):

- Please double-check whether the cables are connected correctly and that they are not loose.
- Please make sure that the cables themselves are not damaged.
- Take care of using the correct ports:
 - the RJ45 plugs below the BNC plug must be used for connecting the cameras
 - EXT.In: input of the external synchronization

2. Check the synchronization settings (software issue):

- Go to **DTRACK3** → *Hardware* → *Synccard* and double-check the settings (internal or external synchronization) for the synccard.

6 Frequently asked questions (FAQ)

- In case of external synchronization, please make sure that the synchronization signal is being sent by the external source.

⇒ How do I guide the synchronization cables correctly in **TRACKPACK** systems (discontinued) ?

TRACKPACK systems do not have hardware-based syncgroups. Up to three syncgroups may be defined within the **DTRACK3** software: **DTRACK3** → *Hardware* → *Cameras* → 'syncgroup'

- The cables should be guided according to the following sketch:

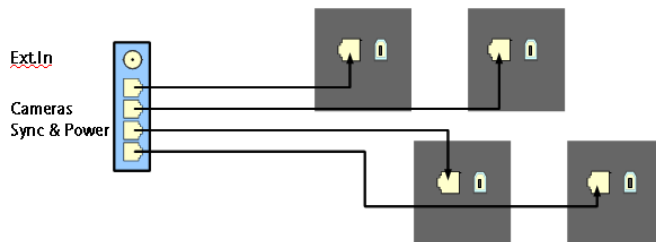

- **Active stereo:** when using external synchronization (video) the correct cabling would look as follows:

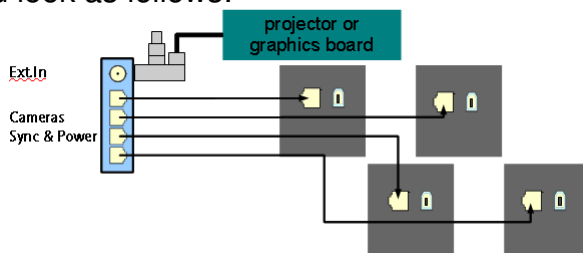

- **Active stereo:** when using external synchronization (TTL) the correct cabling would look as follows:

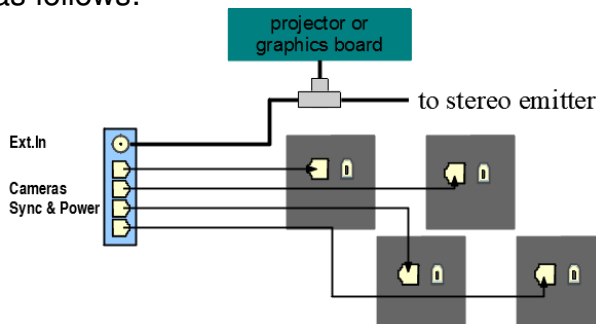

A Technical specifications



The specifications are subject to change without notice.

A.1 Cameras

A.1.1 ARTTRACK6/M and ARTTRACK6/M for Active Markers

IR Source (*ARTTRACK6/M* only)

invisible IR 850 nm
flash intensity adjustable in 100 steps

Performance

Sensor resolution 1.3 MPixels
Frame rate up to 500 Hz

Field of view (FoV)

Lens		Camera mode			
		Full Frame	Medium	Speed	High Speed
		1.3 MPix 180 Hz	1.0 MPix 240 Hz	0.8 MPix 300 Hz	0.5 MPix 500 Hz
F = 2.9 mm	FoV (hor. x vert.) Max. tracking range	135° × 102° 5.0 m	135° × 82° 4.5 m	135° × 61° 3.5 m	77° × 56° 3.5 m
F = 3.5 mm	FoV (hor. x vert.) Max. tracking range	83° × 70° 5.2 m	83° × 61° 4.7 m	83° × 48° 3.9 m	63° × 46° 3.9 m
F = 6.0 mm	FoV (hor. x vert.) Max. tracking range	59° × 46° TBA	59° × 37° TBA	59° × 28° TBA	59° × 26° TBA

tracking ranges based on 12 mm spherical passive markers

Connectivity & Power Supply

single cable solution via Gigabit Ethernet, RJ45, PoE (IEEE 802.3af Standard)
max. cable length 100 m
Voltage 44 - 57 V (defined by the Standard)
max. power consumption *ARTTRACK6/M* 6 W
ARTTRACK6/M for Active Markers 4 W
Protection category III
Interface connectors RJ45 (hosts data, synchronization and power)

A Technical specifications

Operating conditions

Temperature	0 .. 38°C
Relative humidity	5 .. 85% (non-condensing)
Cooling system	passive

Dimensions

Diameter	30 mm
Length	100 mm
Weight	0.1 kg

A.1.2 ARTTRACK5

IR Source

invisible IR	850 nm
flash intensity	adjustable in 100 steps

Performance

Sensor resolution	1.3 MPixels
Frame rate	up to 300 Hz

Field of view (FoV)

Lens		Camera mode		
		Full Frame	Medium	Speed
		1.3 MPix	0.8 MPix	0.5 MPix
		150 Hz	240 Hz	300 Hz
F = 3.5 mm	FoV (hor. x vert.)	98° × 77°	77° × 57°	60° × 44°
	Max. tracking range	5.5 m	5.5 m	5.5 m
F = 4.5 mm	FoV (hor. x vert.)	75° × 60°	60° × 45°	47° × 35°
	Max. tracking range	6.3 m	6.3 m	6.3 m
F = 6.0 mm	FoV (hor. x vert.)	54° × 44°	44° × 33°	34° × 26°
	Max. tracking range	7.5 m	7.5 m	7.5 m

tracking ranges based on 12 mm spherical passive markers

Connectivity & Power Supply

single cable solution via Gigabit Ethernet, RJ45, PoE+ (IEEE 802.3at Standard)	
max. cable length	100 m
Voltage	44 - 57 V (defined by the Standard)
max. power consumption	17 W
Protection category	III
Interface connectors	RJ45 (hosts data, synchronization and power)

Operating conditions

Temperature	0 .. 38°C
Relative humidity	5 .. 85% (non-condensing)
Cooling system	passive

Dimensions

Length	92 mm
Width	100 mm
Height	100 mm
Weight	0.96 kg

A.1.3 ARTTRACK5/C**IR Source**

invisible IR	850 nm
flash intensity	adjustable in 100 steps

Performance

Sensor resolution	1.3 MPixels
Frame rate	up to 300 Hz

Field of view (FoV)

Lens		Camera mode		
		Resolution	Medium	Speed
		1.3 MPix	0.8 MPix	0.5 MPix
		150 Hz	240 Hz	300 Hz
F = 4.0 mm	FoV (hor. x vert.)	89° × 71°	71° × 52°	56° × 42°
	Max. tracking range	4.5 m	4.0 m	3.5 m

tracking ranges based on 12 mm spherical passive markers

Connectivity & Power Supply

single cable solution via Gigabit Ethernet, RJ45, PoE+ (IEEE 802.3at Standard)	
max. cable length	100 m
cable length to remote camera head	0.6 m
Voltage	44 - 57 V (defined by the Standard)
max. power consumption	12 W
Protection category	III
Interface connectors	RJ45 (hosts data, synchronization and power)

Operating conditions

Temperature	0 .. 38°C
Relative humidity	5 .. 85% (non-condensing)
Cooling system	passive

Dimensions remote camera head

Diameter	37 mm
Length	73 mm
Weight	0.16 kg

A Technical specifications

Dimensions camera body

Length	55 mm
Width	100 mm
Height	100 mm
Weight	0.54 kg

A.1.4 TRACKPACK/E

IR Source

invisible IR	850 nm
flash intensity adjustable	in 100 steps

Performance

Sensor resolution	1.1 MPixels
Frame rate	up to 120 Hz

Field of view (FoV)

Lens		Camera mode		
		Resolution	Medium	Speed
		1.1 MPix 60 Hz	0.7 MPix 90 Hz	0.5 MPix 120 Hz
F = 3.5 mm	FoV (hor. x vert.) Max. tracking range	97° × 79° 4.5 m	97° × 51° 4.5 m	97° × 36° 4.5 m

tracking ranges based on 12 mm spherical passive markers

Connectivity & Power Supply

single cable solution via Gigabit Ethernet, RJ45, PoE (IEEE 802.3af Standard)	
max. cable length	100 m
Voltage	44 - 57 V (defined by the Standard)
max. power consumption	5 W
Protection category	III
Interface connectors	RJ45 (hosts data, synchronization and power)

Operating conditions

Temperature	0 .. 38°C
Relative humidity	5 .. 85% (non-condensing)
Cooling system	passive

Dimensions

Length	103 mm
Width	70 mm
Height	59 mm
Weight	0.51 kg

A.2 Controller

A.2.1 ART Controller

Mounting type

Rackmount (19")

Power Supply

Input voltage 100 - 240 V
max. power consumption 425 W

Protection Category

Power Supply I

Connectivity

Synchronization in 1, BNC: Video Signal (75 Ω), TTL, LVTTTL
Synchronization out (optional) 3, BNC: Video Signal (75 Ω)
Camera ports 8, RJ45, Ethernet 1 GBit/s, PoE+
Data in/out 2, RJ45, Ethernet 1 GBit/s
Peripherals 6, USB (5 V max. 500 mA), radio communication via *Radio-Transceiver2/3*

Operating conditions

Temperature 0 .. 38°C
Relative humidity 5 .. 85% (non-condensing)

Dimensions

Width 480 mm
Height 135 mm
Depth 345 mm
Weight 9.8 kg

Hazard notes for service personnel:



Risk of explosion if the mainboard battery is incorrectly replaced. Replace only with the same or from manufacturer recommended similar type.



In order to replace mains fuses (e.g. *ART Controller*) always unplug the power cord first. Risk of electric shock !



There are two mains fuses since two power supplies are installed. So the device is possibly still live although only one fuse has blown.

A.2.2 ART Controller/M

Mounting type

Stand-alone

External Power Supply

Input voltage	100 - 240 V
Output voltage	48 V DC
max. power consumption	160 W

Protection Category

External Power Supply	I
ART Controller/M	III

Connectivity

Synchronization in	1, BNC: Video Signal (75 Ω), TTL, LVTTTL
Synchronization out	1, BNC: Video Signal (75 Ω)
Camera ports	8, RJ45, Ethernet 1 GBit/s, PoE+
Data in/out	2, RJ45, Ethernet 1 GBit/s
Peripherals	8, USB (5 V max. 500 mA), radio communication via Radio-Transceiver2/3

Operating conditions

Temperature	0 .. 45°C
Relative humidity	5 .. 95% (non-condensing)
Cooling system	active internal fan (optional external fan available)

Dimensions

Width	227 mm
Height	126 mm
Depth	261 mm
Weight	5.2 kg

Hazard notes for service personnel:



Risk of explosion if the mainboard battery is incorrectly replaced. Replace only with the same or from manufacturer recommended similar type.

A.3 Integrated Systems

A.3.1 SMARTTRACK3 & SMARTTRACK3/M

IR Source

invisible IR	850 nm
flash intensity adjustable	in 100 steps

Performance

Sensor resolution	1.3 MPixels
Frame rate	max. 240 Hz (adjustable)
Maximum number of 6DOF targets (simultaneously)	@ 240 Hz > 4

Field of view (FoV)

Lens		Camera mode		
		Resolution 1.3 MPix 150 Hz	Medium 1.1 MPix 180 Hz	Speed 0.8 MPix 240 Hz
SMARTTRACK3				
F = 2.9 mm	FoV (hor. x vert.) Max. tracking range	135° × 102° 3.5 m	135° × 86° 3.5 m	135° × 62° 3.5 m
SMARTTRACK3/M				
F = 2.9 mm	FoV (hor. x vert.) Max. tracking range	135° × 102° 1.7 m	135° × 86° 1.7 m	135° × 62° 1.7 m
F = 3.5 mm	FoV (hor. x vert.) Max. tracking range	83° × 70° 2.3 m	83° × 62° 2.3 m	83° × 49° 2.3 m

tracking ranges based on 12 mm spherical passive markers

Power Supply, (External PoE injector)

Input voltage	100 - 240 V
Output voltage	44 - 57 V DC (defined by the Standard IEEE 802.3af)
max. power consumption	12 W

Protection Category

Ext. PoE injector (power supply)	I
SMARTTRACK3 & SMARTTRACK3/M	III

Connectivity

single cable solution via	Gigabit Ethernet, RJ45, PoE (IEEE 802.3af Standard)
max. cable length	100 m (including data connection cable to remote PC)
data in/out & power	1, RJ45
synchronization in	1, BNC: Video Signal (75 Ω), TTL, LVTTTL

A Technical specifications

synchronization out peripherals 1, BNC: Video Signal (75 Ω), TTL
1, USB (5 V max. 500 mA), radio communication via *RadioTransceiver2/3*

Operating conditions

Temperature 0 .. 35°C
Relative humidity 5 .. 85% (non-condensing)
Cooling system passive

Dimensions *SMARTTRACK3*

Width 380 mm
Height 55 mm
Depth 95 mm
Weight 1.5 kg

Dimensions *SMARTTRACK3/M*

Width 280 mm
Height 40 mm
Depth 90 mm
Weight 1.0 kg

A.4 Flystick2 & Flystick2+

	Flystick2	Flystick2+
Power supply		
Rechargeable battery ¹	3 Micro-AAA batteries	2 AA batteries
Continuous operation ²	at least 10 hours	at least 80 hours
Battery charging duration		typically 5 h
Operation possible with connected charger	no	yes
Radio module		
Type ID	IEEE 802.15.4	IEEE 802.15.4
Frequency	2.4 GHz	2.4 GHz
Transmission power	4 dBm (2.5 mW)	4 dBm (2.5 mW)
Radio range (depending on setup location, e.g. walls)	at least 7 m	at least 7 m
Operating conditions		
Operating temperature	0 .. 40°C	0 .. 40°C
Relative humidity	5 .. 85%, non-condensing	5 .. 85%, non-condensing
General features		
Target type	passive markers	passive markers
Tracking range (@ 3.5 mm focal length)	approx. 4 m	approx. 4 m
Weight	250 g	250 g
Size	220 mm x 180 mm x 100 mm	183 mm x 188 mm x 99 mm

¹ replacement after a period of 2 years is recommended

² valid for new batteries

A.5 Fingertracking

A.5.1 FINGERTRACKING2

Function

Synchronization	via modulated IR flash
Battery ¹	2 Micro-AAA batteries, 1.2 - 1.5 V, typ. 900 mAh
Continuous operation ²	typ. 9 hours
Continuous operation ³	typ. 12 hours

Battery charger

Input	AC 100 - 240 V, 50/60 Hz, 0.25 A or DC 9 - 12 V, 1 A
Charging time ¹	approx. 2 hours
Weight (without batteries)	approx. 0.2 kg

Operating conditions

Operating temperature	5 .. 40°C
Relative humidity	5 .. 85%, non-condensing

Dimensions

Thimble set	available in 4 different sizes (extra-small, small, medium, large)
Weight Handset	85 g
Weight Thimbles	25 g

Performance

Frame rate (handtarget)	up to 300 Hz
Frame rate (thimbles, 3-finger version)	up to 100 Hz with handtarget @ 300 Hz
Frame rate (thimbles, 5-finger version)	up to 60 Hz with handtarget @ 300 Hz
Tracking range	typ. 4-5 m (depending on focal length of the cameras)

¹ valid for new batteries

² 150 Hz tracking frequency, LED brightness high

³ 150 Hz tracking frequency, LED brightness low

A.5.2 FINGERTRACKING2 Tactile

Function	
Synchronization	via modulated IR flash
Battery ¹	2 Micro-AAA batteries, 1.2 - 1.5 V, typ. 900 mAh
Continuous operation with tactile feedback ²	typ. 6 hours
Continuous operation no tactile feedback ³	typ. 9 hours
Continuous operation no tactile feedback ⁴	typ. 12 hours
Battery charger	
Input	AC 100 - 240 V, 50/60 Hz, 0.25 A or DC 9 - 12 V, 1 A
Charging time ¹	approx. 2 hours
Weight (without batteries)	approx. 0.2 kg
Radio module	
Type ID	IEEE 802.15.4
Frequency	2.4 GHz
Transmission power	3 dBm (2.0 mW)
Operating conditions	
Operating temperature	5 .. 40°C
Relative humidity	5 .. 85%, non-condensing
Dimensions	
Thimble set	available in 4 different sizes (extra-small, small, medium, large)
Weight Handset	85 g
Weight Thimbles	25 g
Performance	
Frame rate (handtarget)	up to 300 Hz
Frame rate (thimbles, 3-finger version)	up to 100 Hz with handtarget @ 300 Hz
Tracking range	typ. 4-5 m (depending on focal length of the cameras)

¹ valid for new batteries

² 150 Hz tracking frequency, LED brightness high, 2 vibrations per 5 seconds (vibrations 1 second in duration)

³ 150 Hz tracking frequency, LED brightness high

³ 150 Hz tracking frequency, LED brightness low

A.6 Discontinued products

A.6.1 ARTTRACK cameras

	ARTTRACK2.2 from S/N #1800	ARTTRACK3.2 from S/N #400	ARTTRACK2	ARTTRACK3
IR flash	880 nm	850 nm	880 nm	850 nm
Power supply				
Nominal voltage	12 V	48 V	12 V	48 V
Maximal current	2 A	1.4 A	2 A	1.4 A

A Technical specifications

	ARTTRACK2.2 from S/N #1800	ARTTRACK3.2 from S/N #400	ARTTRACK2	ARTTRACK3
IR flash	880 nm	850 nm	880 nm	850 nm
Maximal power	25 W	35 W	25 W	35 W
Ext. power supply	12.2 V / 3 A / 40 W 12.5 V / 3 A / 40 W	48 V / 0.8 A / 40 W 48.2 V / 0.8 A / 40 W	12.2 V / 3 A / 40 W 12.5 V / 3 A / 40 W	48 V / 0.8 A / 40 W 48.2 V / 0.8 A / 40 W
Protection category				
Ext. power supply	I	I	I	I
Camera	III	III	III	III
Interface connectors				
data	RJ45	RJ45	RJ45	RJ45
synchronization	BNC	BNC	BNC	BNC
power	external	external	external	external
Operating conditions				
Temperature	0 .. 38°C	0 .. 38°C	0 .. 38°C	0 .. 38°C
Relative humidity	5 .. 85%	5 .. 85%	5 .. 85%	5 .. 85%
Cooling system	non-condensing active (fan) → noise level of the fan: 16.5 dB(A)	non-condensing passive	non-condensing active (fan) → noise level of the fan: 16.5 dB(A)	non-condensing passive
Dimensions				
Length	140 mm	140 mm	140 mm	140 mm
Width	78 mm	106 mm	78 mm	106 mm
Height	109 mm	120 mm	109 mm	120 mm
Weight	0.96 kg	1.45 kg	0.96 kg	1.45 kg
Performance				
Frame rate	max. 60 fps (adjustable)	max. 60 fps (adjustable)	max. 60 fps (adjustable)	max. 60 fps (adjustable)
Max. working distance with 12mm passive markers (F .. focal length in mm). Greater distances achievable with bigger passive markers (e.g. 30 mm) or active markers.				
@ F = 2.6 mm	4.5 m	4.5 m	4.5 m	4.5 m
@ F = 3.5 mm	4.5 m	4.5 m	4.5 m	4.5 m
@ F = 4.5 mm	4.5 m	6 m	4.5 m	6 m
@ F = 6.0 mm	4.5 m	7 m	4.5 m	7 m
Maximum number of 6DOF targets (simultaneously)				
@ 60 fps	70	70	70	70
Field of view (FoV, horizontal × vertical)				
@ F = 2.6 mm	88° × 58°	88° × 58°	-	-
@ F = 3.5 mm	67° × 45°	67° × 45°	72.8° × 58.2°	72.8° × 58.2°
@ F = 4.5 mm	-	52° × 35°	57.9° × 45.3°	57.9° × 45.3°
@ F = 6.0 mm	-	-	42.9° × 33.0°	42.9° × 33.0°
<i>other focal lengths on request</i>				

A.6.2 TRACKPACK cameras

	<i>TRACKPACK</i>	<i>TRACKPACK/C</i>
IR flash	850 nm	850 nm
Power supply		
Nominal voltage	12 V	12 V
Maximal current	0.5 A	0.5 A
Maximal power	6 W	6 W
Ext. power supply	-	-
Protection category		
Ext. power supply	-	-
Camera	III	III
Interface connectors		
data	IEEE1394	IEEE1394
synchronization	RJ45	RJ45
power	RJ45	RJ45
Operating conditions		
Temperature	0 .. 38°C	0 .. 38°C
Relative humidity	5 .. 85%	5 .. 85%
Cooling system	non-condensing passive	non-condensing passive
Dimensions		
Length	77.8 mm	228 mm
Width	76.9 mm	76.9 mm
Height	60 mm	58 mm
Weight	0.45 kg	0.45 kg
Performance		
Frame rate	max. 60 fps (adjustable)	max. 60 fps (adjustable)
Max. working distance with 12 mm passive markers (F .. focal length in mm). Greater distances achievable with bigger passive markers (e.g. 30 mm) or active markers.		
@ F = 2.6 mm	2.5 m	-
@ F = 3.5 mm	3.5 m	3.5 m
@ F = 4.5 mm	3.5 m	-
@ F = 6.0 mm	3.5 m	-
Maximum number of 6DOF targets (simultaneously)		
@ 60 fps	4 - 70	4 - 70
Field of view (FoV, horizontal × vertical)		
@ F = 2.6 mm	93.5° × 77.2°	-
@ F = 3.5 mm	72.8° × 58.2°	72.8° × 58.2°
@ F = 4.5 mm	57.9° × 45.3°	-
@ F = 6.0 mm	42.9° × 33.0°	-
<i>other focal lengths on request</i>		

A.6.3 SMARTTRACK2

Power supply

Nominal voltage	5 V DC
Maximal current	4 A
Maximal power	20 W
Ext. power supply	5 V / 4 A / 20 W

Protection category

Ext. power supply	I
Camera	III

Interface connectors

data	RJ45
synchronization	BNC
power	external
peripherals	USB (5 V max. 500 mA)
Flystick2 and 3	internal Radio Transceiver, no external USB Radio Transceiver is allowed

Operating conditions

Temperature	0 .. 35°C
Relative humidity	5 .. 85%
	non-condensing
Cooling system	active (fan)

Dimensions

Length	approx. 420 mm
Width	approx. 105 mm
Height	approx. 55 mm
Weight	approx. 1.3 kg

Performance

Frame rate	max. 60 fps (adjustable)
IR flash	850 nm
Max. tracking distance with 12 mm passive markers (F .. focal length in mm).	
@ F = 2.1 mm	2.5 m
Maximum number of 6DOF targets (simultaneously)	
@ 60 fps	> 4
Field of view (FoV for each lens, horizontal × vertical)	
@ F = 2.1 mm	100° × 84°

A.6.4 Flystick3

Flystick3

Power supply	
Rechargeable battery ¹	lithium battery (850 mAh / 3.7 V) integrated in the handheld
Continuous operation ²	at least 8 hours
Battery charging duration	
Operation possible with connected charger	yes
USB transmitter	
Connection to the PC	USB
Radio range (depending on setup location, e.g. walls)	at least 7 m
Radio module	
Type ID	IEEE 802.15.4
Frequency	2.4 GHz
Transmission power	4 dBm (2.5 mW)
Operating conditions	
Operating temperature	0 .. 38°C
Relative humidity	5 .. 85%, non-condensing
General features	
Target type	passive or active markers (IR-LEDs @ 880 nm)
Tracking range (@ 3.5 mm focal length)	approx. 4.5 m
Weight	120 g
Size	245 mm x 90 mm x 75 mm

¹ replacement after a period of 2 years is recommended

² valid for new batteries

A.6.5 Fingertracking

Function	
Synchronization	via modulated IR flash
Battery	NB-4L Li-Ion battery, 3.7 V, 700 mAh
Battery charger	
Input	12 V, 500 mA
Power supply	230 V, 50 Hz, 12 W
Continuous operation ¹	approx. 10 hours
Weight (incl. power supply)	380 g
Operating conditions	
Operating temperature	0 .. 38°C
Relative humidity	5 .. 85%, non-condensing
Dimensions	
Thimble set	available in 3 different sizes (small, medium, large)
Weight	60 g
Performance	
Frame rate (handtarget)	60 Hz
Frame rate (thimbles, 3-finger version)	20 Hz
Frame rate (thimbles, 5-finger version)	12 Hz
Tracking range	4 m (depending on focal length of the cameras)

¹ only valid for new batteries

A.7 Overall system

System parameters

number of cameras	2 - 80 (max. 16 for TRACKPACK/E and TRACKPACK systems)
max. number of targets	70
max. number of hands	4
max. number of Flysticks	
- Flystick2	5
- Flystick2+	5
- Flystick3	2
Scalability	ARTTRACK system: fully scalable (2 - 80 cameras) TRACKPACK/E system: cascadable up to 16 cameras (additional controller necessary) TRACKPACK systems (discontinued): cascadable as slave(s) only
Accuracy	
- of the timestamp	with a Synccard2/3: $\Delta t_{err} \sim \pm 0.01ms$ with a SynccardTP: $\Delta t_{err} \sim \pm 0.5ms$ with a SMARTTRACK3 & SMARTTRACK3/M : $\Delta t_{err} \sim \pm 0.01ms$ with a SMARTTRACK2 : $\Delta t_{err} \sim \pm 0.5ms$ with a 3-Space wired inertial sensor: $\Delta t_{err} \sim \pm 0.1ms$

Compatible shutter glasses

NuVision APG6000	×
NuVision APG6100	×
NVidia 3D Vision Pro	×, radio synchronization
RealD CE1	×
RealD CE2	×
RealD CE3	×
RealD CE4	-
RealD CE5	×
Volfoni EDGE	×, with Volfoni or NuVision Long-Range Emitter
XPand X103	×, with NuVision Long-Range Emitter
XPand X101	×
XPand X104LX	×
Virtualis ActiveWorks 500	×

DTRACK3 frontend software

System requirements	
- Free disk space	≥ 200MB
- Processor	Intel: ≥ P4 2GHz AMD: ≥ K6 1.6Ghz
- RAM	≥ 1GB
Operating systems	Windows 7 32/64 Bit with Service Pack 1 Windows 8/8.1 32/64 Bit Windows 10 32/64 Bit Linux openSUSE ≥ 15.0 64 Bit Linux Ubuntu ≥ 18.04 64 Bit Linux CentOS ≥ 7.5 64 Bit Linux Debian ≥ 10.0 64 Bit

Used IP ports in Controller

Controller		DTRACK3 frontend	purpose
TCP 50105	↔	TCP dynamic	general communication
UDP 50105	↔	UDP dynamic	general communication
UDP 50107	→	UDP dynamic	measurement data (6DOF, timestamps, etc.)
Controller		user's application (e.g. DTrackSDK)	purpose
TCP 50105	↔	TCP variable	remote commands (optional)
UDP 50107	→	UDP user-defined (default: 5000)	measurement data (6DOF, timestamps, etc.)
UDP 50110	←	UDP variable	control commands (optional; for FINGERTRACKING2 Tactile or Flystick feedback devices)

'dynamic' port defined by the OS; can be among all local ports within the accessible range of the OS (i.e. from the pool of 'registered ports' in Microsoft WINDOWS)

'variable' port arbitrary, by design of the user's application

'user-defined' port defined from within the frontend (Menu *Tracking* → *Output*)

A.8 Declaration of conformity



EUROPEAN DECLARATION OF CONFORMITY STATEMENT

Advanced Realtime Tracking GmbH

declares under its sole responsibility that the product

ARTTRACK6/M

to which this declaration relates is in conformity to the following standard(s) or other normative document(s)

2014/30/EC (EMC Directive): EN 55032:2015
EN 55035:2017

2011/65/EC (RoHS Directive): EN 63000:2018

Weilheim i. OB, 24.11.2020

A handwritten signature in blue ink, appearing to read 'A. Weiss', is written over a horizontal line.

Dr. A. Weiss (Managing Director)

Advanced Realtime Tracking GmbH Am Öferl 6 82362 Weilheim i. OB Germany



Supplier's Declaration of Conformity

This Declaration of Conformity is hereby issued according to Chapter 1, Subpart A, Part 2 of Title 47 of the Code of Federal Regulations by:

Advanced Realtime Tracking GmbH & Co. KG
Am Oeferl 6
82362 Weilheim i. OB
Germany

EQUIPMENT "ARTTRACK6/M" complies with the applicable requirements of FCC Rule Part 15

RESPONSIBLE PARTY located in the United States:

Violette Engineering Corporation
6731 Whittier Avenue
McLean, VA 22101
info@violettecorp.com

The responsible party warrants that each unit of equipment marketed under this Declaration of Conformity will be identical to the unit tested and found acceptable with the standards and that the records maintained by the responsible party continue to reflect the equipment being produced under such Supplier's Declaration of Conformity continue to comply within the variation that can be expected due to quantity production and testing on a statistical basis.

Weilheim i. OB, 24.03.2021



Dr. A. Weiss (Managing Director)



Advanced Realtime Tracking GmbH & Co. KG Am Öferl 6 82362 Weilheim i. OB Germany





EUROPEAN DECLARATION OF CONFORMITY STATEMENT

Advanced Realtime Tracking GmbH & Co. KG

declares under its sole responsibility that the product

ARTTRACK5

to which this declaration relates is in conformity to the following standard(s) or other normative document(s)

2014/30/EC (EMC Directive): EN 55032:2015
EN 55035:2017

2011/65/EC (RoHS Directive): EN 63000:2018

Weilheim i. OB, 03.06.2022



Dr. A. Weiss (Managing Director)

Advanced Realtime Tracking GmbH & Co. KG Am Öferl 6 82362 Weilheim i. OB Germany





**MANUFACTURER'S FEDERAL COMMUNICATION COMMISSION
DECLARATION OF CONFORMITY STATEMENT**

Advanced Realtime Tracking GmbH

declares under its sole responsibility that the product

ARTTRACK5

to which this declaration relates is in conformity to the following standard:

**FCC 47 CFR Part 15, Subpart B
Class B digital device**

Operation is subject to the following two conditions:

- (1) this device may not cause harmful interference, and
- (2) this device must accept any interference received, including interference that may cause undesired operation.

Weilheim i. OB, 14.11.2014

A handwritten signature in blue ink, appearing to read 'A. Weiss', is written over a horizontal line. Below the line, the text 'Dr. A. Weiss (Managing Director)' is printed.

Advanced Realtime Tracking GmbH Am Öferl 6 82362 Weilheim i. OB Germany





EUROPEAN DECLARATION OF CONFORMITY STATEMENT

Advanced Realtime Tracking GmbH & Co. KG

declares under its sole responsibility that the product

ARTTRACK5/C

to which this declaration relates is in conformity to the following standard(s) or other normative document(s)

2014/30/EC (EMC Directive): EN 55032:2015 +
EN 55035:2017

2011/65/EC (RoHS Directive): EN 63000:2018

Warning: Operation of this equipment in a residential environment could cause radio interference.

Weilheim i. OB, 03.06.2022



Dr. A. Weiss (Managing Director)

Advanced Realtime Tracking GmbH & Co. KG Am Öferl 6 82362 Weilheim i. OB Germany



MANUFACTURER'S FEDERAL COMMUNICATION COMMISSION DECLARATION OF CONFORMITY STATEMENT

Advanced Realtime Tracking GmbH

declares under its sole responsibility that the product

ARTTRACK5/C

to which this declaration relates is in conformity to the following standard:

FCC 47 CFR Part 15, Subpart B Class A digital device

Operation is subject to the following two conditions:

- (1) this device may not cause harmful interference, and
- (2) this device must accept any interference received, including interference that may cause undesired operation.

This is a class A product. In a domestic environment this product may cause radio interference in which case the user may be required to take adequate measures.

Weilheim i. OB, 28.10.2015

A handwritten signature in blue ink, appearing to read 'A. Weiss', is written over a horizontal line. Below the line, the text 'Dr. A. Weiss (Managing Director)' is printed.

Advanced Realtime Tracking GmbH Am Öferl 6 82362 Weilheim i. OB Germany



EUROPEAN DECLARATION OF CONFORMITY STATEMENT

Advanced Realtime Tracking GmbH & Co. KG

declares under its sole responsibility that the product

TRACKPACK/E

to which this declaration relates is in conformity to the following standard(s) or other normative document(s)

2014/30/EC (EMC Directive): EN 55032:2015
EN 55035:2017

2011/65/EC (RoHS Directive): EN 63000:2018

Weilheim i. OB, 03.06.2022



Dr. A. Weiss (Managing Director)

Advanced Realtime Tracking GmbH & Co. KG Am Öferl 6 82362 Weilheim i. OB Germany





**MANUFACTURER'S FEDERAL COMMUNICATION COMMISSION
DECLARATION OF CONFORMITY STATEMENT**

Advanced Realtime Tracking GmbH

declares under its sole responsibility that the product

TRACKPACK/ E

to which this declaration relates is in conformity to the following standard:

**FCC 47 CFR Part 15, Subpart B
Class B digital device**

Operation is subject to the following two conditions:

- (1) this device may not cause harmful interference, and
- (2) this device must accept any interference received, including interference that may cause undesired operation.

Weilheim i. OB, 11.12.2014

A handwritten signature in blue ink, appearing to read 'A. Weiss', is written over a horizontal line. Below the line, the text 'Dr. A. Weiss (Managing Director)' is printed.

Advanced Realtime Tracking GmbH Am Öferl 6 82362 Weilheim i. OB Germany





EUROPEAN DECLARATION OF CONFORMITY STATEMENT

Advanced Realtime Tracking GmbH & Co. KG

declares under its sole responsibility that the product

ART Controller

to which this declaration relates is in conformity to the following standard(s) or other normative document(s)

2014/35/EC (Low Voltage Directive): EN 62368-1:2014 +
A11:2017

2014/30/EC (EMC Directive): EN 55032:2015
EN 55035:2017

2011/65/EC (RoHS Directive): EN 63000:2018

Weilheim i. OB, 03.06.2022



Dr. A. Weiss (Managing Director)

Advanced Realtime Tracking GmbH & Co. KG Am Öferl 6 82362 Weilheim i. OB Germany





Supplier's Declaration of Conformity

This Declaration of Conformity is hereby issued according to Chapter 1, Subpart A, Part 2 of Title 47 of the Code of Federal Regulations by:

Advanced Realtime Tracking GmbH & Co. KG
Am Oeferl 6
82362 Weilheim i. OB
Germany

EQUIPMENT "ART Controller" complies with the applicable requirements of FCC Rule Part 15

This is a class A product. In a domestic environment this product may cause radio interference in which case the user may be required to take adequate measures.

RESPONSIBLE PARTY located in the United States:

Violette Engineering Corporation
6731 Whittier Avenue
McLean, VA 22101
info@violettecorp.com

The responsible party warrants that each unit of equipment marketed under this Declaration of Conformity will be identical to the unit tested and found acceptable with the standards and that the records maintained by the responsible party continue to reflect the equipment being produced under such Supplier's Declaration of Conformity continue to comply within the variation that can be expected due to quantity production and testing on a statistical basis.

Weilheim i. OB, 24.03.2021



Dr. A. Weiss (Managing Director)



Advanced Realtime Tracking GmbH & Co. KG Am Öferl 6 82362 Weilheim i. OB Germany





EU- Konformitätserklärung
EU-Declaration of Conformity

Die Firma: **Spectra GmbH & Co. KG, Mahdenstraße 3,**
company: **72768 Reutlingen, Germany**

erklärt unter alleiniger Verantwortung , dass das Produkt
declares under the sole responsibility, that the product

Produkt: Mini PC
Product:

Art.Nr. 159845
Item no.

Produktbezeichnung: Spectra PowerBox 32C0 D40723 V2. (incl. möglicher nachfolgender Erweiterung)
Product description: (possibly followed by suffix)

Erstausgabjahr: 2019
Initial CE declaration:

mit den Bestimmungen der nachfolgenden EU-Richtlinien übereinstimmt.
Is in conformity with the provisions of the following European Directives.

EMV Richtlinie 2014/30/EU

Richtlinie des Europäischen Parlaments und des Rates vom 26. Februar 2014 zur Harmonisierung der Rechtsvorschriften der Mitgliedstaaten über die elektromagnetische Verträglichkeit.
Directive 2014/30/EU of the European Parliament and of the Council of 26 February 2014 on the harmonisation of the laws of the Member States relating to electromagnetic compatibility.

Die Konformität mit der Richtlinie wird nachgewiesen durch die Einhaltung folgender Normen:
Compliance is proved by the application of the following standards:

- **EN 55032:2015 /A11:2020 (ClassA)**
Elektromagnetische Verträglichkeit von Multimediaegeräten und -einrichtungen, Anforderungen an die Störaussendung.
Electromagnetic compatibility of multimedia equipment - Emission requirements.

- **EN 61000-3-2:2019**
Elektromagnetische Verträglichkeit (EMV) - Teil 3-2: Grenzwerte für Oberschwingungsströme (Geräte-Eingangstrom ≥ 16 A je Leiter).
Electromagnetic compatibility (EMC). Part 3-2: Limits - Limits for harmonic current emissions (equipment input current ≤ 16 A per phase).

- **EN 61000-3-3:2013**
Elektromagnetische Verträglichkeit (EMV) - Teil 3-3: Grenzwerte - Begrenzung von Spannungsänderungen, Spannungsschwankungen und Flicker in öffentlichen Niederspannungs-Versorgungsnetzen für Geräte mit einem Bemessungsstrom ≤ 16 A je Leiter.
Electromagnetic compatibility (EMC). - Part 3-3: Limits. Limitation of voltage changes, voltage fluctuations and flicker in public low-voltage supply systems, for equipment with rated current ≤ 16 A per phase.



Declaration of Conformity

For the following equipment :

Product Name: Switching Power supply

Model Designation: GST160Ax (x=12,15,20,24,36,48)

is herewith confirmed to comply with the requirements set out in the Council Directive, the following standards were applied :

RoHS Directive (2011/65/EU), (EU)2015/863

Low Voltage Directive (2014/35/EU) :

EN 62368-1:2014+A11 TUV certificate No : S 50447160

Electromagnetic Compatibility Directive (2014/30/EU) :

EMI (Electro-Magnetic Interference)

Conducted emission / Radiated emission	EN 55032:2015+A1:2020	
	EN IEC 61204-3:2018	Class B

Harmonic current	EN IEC 61000-3-2:2019+A1:2021
------------------	-------------------------------

Voltage flicker	EN 61000-3-3:2013+A1:2019
-----------------	---------------------------

EMS (Electro-Magnetic Susceptibility)

EN 55035:2017+A11:2020	EN IEC 61204-3:2018
------------------------	---------------------

ESD air	EN 61000-4-2:2009	Level 4	15KV
---------	-------------------	---------	------

ESD contact	EN 61000-4-2:2009	Level 4	8KV
-------------	-------------------	---------	-----

RF field susceptibility	EN IEC 61000-4-3:2020	Level 3	10V/m
-------------------------	-----------------------	---------	-------

EFT bursts	EN 61000-4-4:2012	Level 3	2KV/5KHz
------------	-------------------	---------	----------

Surge susceptibility	EN 61000-4-5:2014+A1:2017	Level 3	1KV/Line-Line
----------------------	---------------------------	---------	---------------

Surge susceptibility	EN 61000-4-5:2014+A1:2017	Level 3	2KV/Line-Earth
----------------------	---------------------------	---------	----------------

Conducted susceptibility	EN 61000-4-6:2014	Level 3	10V
--------------------------	-------------------	---------	-----

Magnetic field immunity	EN 61000-4-8:2010	Level 4	30A/m
-------------------------	-------------------	---------	-------

Voltage dip, interruption	EN IEC 61000-4-11:2020	>95% dip 0.5 periods	30% dip 25 periods	>95% interruptions 250 periods
---------------------------	------------------------	----------------------	--------------------	--------------------------------

Note:

The power supply is considered as a component that will be operated in combination with final equipment. Since EMC performance will be affected by the complete system, the final equipment manufacturers must re-qualify EMC Directive on the complete system again.

For guidance on how to perform these EMC tests, please refer to TDF (Technical Documentation File).

Energy-Related Products Directive (2009/125/EC) :

Ecodesign requirements for no-load condition electric power consumption and average active efficiency of external power supplies (EU)2019/1782

This Declaration is effective from serial number SC1xxxxxxx

Person responsible for marking this declaration :

MEAN WELL Enterprises Co., Ltd.
(Manufacturer Name)

No.28, Wuquan 3rd Rd., Wugu Dist., New Taipei City 24891, Taiwan
(Manufacturer Address)

Aries Jian/ Director, Group R&D: Aries
(Name / Position) (Signature)

Alex Tsai/ Director, Product Strategy Center: [Signature]
(Name / Position) (Signature)

Taiwan Aug. 2nd, 2021
(Place) (Date)

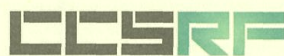

VERIFICATION OF COMPLIANCE

This Verification of Compliance is hereby issued to the below named company and for below described product, based on

**Technical Standard : FCC 47 CFR Part 15 Subpart B
ANSI C63.4: 2014
ISED ICES-003 (Issue 6)**

General Information

Applicant : Spectra GmbH & Co. KG
Address of Applicant : Mahdenstraße 3, D-72768 Reutlingen, Germany

Product Description

Product Name : Rugged Embedded Computer
Model Number : PowerBox 30C0; PowerBox 31C0; PowerBox 32C0

Measurement Facilities

Company Name : **Compliance Certification Services Inc.**
Test Laboratory : Xindian Lab.
Address of Test Lab. : No.163-1, Jhongsheng Rd., Xindian Dist., New Taipei City, 23151 Taiwan.

This device has been tested and found to be in compliance with the measurement procedures specified in the Standards & Specifications listed above and as indicated in the measurement report with the number: T180927D01-F

The test results shown in this report are applicable only to the investigated sample identified in this report.

Jason Lee / Section Manager

Date: October 24, 2018

This document is issued by the Company subject to its General Conditions of Service printed overleaf, available on request or accessible at www.sgs.com/terms_and_conditions.htm and for electronic format documents, subject to Terms and Conditions for Electronic Documents at www.sgs.com/terms_e-document.htm. Attention is drawn to the limitation of liability, indemnification and jurisdiction issues defined therein. Any holder of this document is advised that information contained hereon reflects the Company's findings at the time of its intervention only and within the limits of Client's instructions, if any. The Company's sole responsibility is to its Client and this document does not exonerate parties to a transaction from exercising all their rights and obligations under the transaction documents. This document cannot be reproduced except in full, without prior written approval of the Company. Any unauthorized alteration, forgery or falsification of the content or appearance of this document is unlawful and offenders may be prosecuted to the fullest extent of the law.

SGS Compliance Certification Service Inc.
程智科技股份有限公司

No.163-1, Jhongsheng Road, Xindian District, New Taipei City 23151, Taiwan / 新北市新店區中生路 163-1 號
t:(886-2) 2217-0894 f:(886-2) 2217-1029 www.sgs.tw www.ccsrf.com

Member of the SGS Group (SGS SA)



VERIFICATION OF COMPLIANCE

This Verification of Compliance is hereby issued to the below named company. The test results of this report relate only to the tested sample identified in this report.

**Technical Standard: FCC Part 15 Class B
ICES-003 Issue 5
AS/NZS CISPR 22**

General Information

Applicant: N/A

Product Description

EUT Description: Switching Power Supply
Brand Name: MEANWELL
Model Number: GST160Ax (x=12,15,20,24,36,48)

Measurement Facilities

Laboratory: **Compliance Certification Services Inc.**
*No. 81-1, Lane 210, Bade 2nd Rd., Lujhu Township,
Taoyuan county 33841, Taiwan, (R.O.C.)
Tel: 886-3-324-0332 / Fax: 886-3-324-5235*

*This device has been shown to be in compliance with and was tested in accordance with the measurement procedures specified in the Standards & specifications listed above and as indicated in the measurement report number: **T160108L01-EF***



Miller Lee

Miller Lee / Section Manager
Date: January 07, 2016

CCSRF 程智电子科技有限公司
Compliance Certification Services Inc.



EUROPEAN DECLARATION OF CONFORMITY STATEMENT

Advanced Realtime Tracking GmbH & Co. KG

declares under its sole responsibility that the product

SMARTTRACK3

to which this declaration relates is in conformity to the following standard(s) or other normative document(s)

2014/30/EC (EMC Directive): EN 55032:2015
EN 55035:2017

2011/65/EC (RoHS Directive): EN 63000:2018

Weilheim i. OB, 03.06.2022



Dr. A. Weiss (Managing Director)

Advanced Realtime Tracking GmbH & Co. KG Am Öferl 6 82362 Weilheim i. OB Germany





your power partner

186 Veterans Drive, Northvale, NJ 07647 USA

www.globtek.com

<https://www.globtek.com/iso-certificates/>

Delivering leading edge, innovative power solutions for over 30 years since 1984

EC Declaration of Conformity



For the following equipment: Single Port Power Over Ethernet Midspan (IEEE802.3af PoE PSE)
(Product Name)

GT-96180-1856-T3-AP
(Model Designation)

GlobTek, Inc. USA, 186 Veterans Drive, Northvale, NJ USA 07647
(Manufacturer Name and Address)

is herewith confirmed to comply with the requirements set out in the Council Directive on the Approximation of the Laws of the Member States relating to and applying the following standards:

- Electromagnetic Compatibility Directive (2014/30/EU)
 - EMI (Electro-Magnetic Interference)
 - EN 55032:2015/AC:2016 Class B
 - Harmonic Flicker EN 61000-3-2:2014
 - Voltage Flicker EN 61000-3-3:2013
 - EMS (Electro-Magnetic Susceptibility) EN 55024:2010 and EN55024:2010/A1:2015
- Low-Voltage Directive (2014/35/EU)
 - Information Technology Equipment EN 60950-1: 2006 (2nd Edition) A11:2009; A1:2010; A12:2011+A2:2013
 - Audio/video, information and communication technology equipment EN/IEC 62368-1:2014 (2nd Edition)
- Energy-Related Products Directive 2009/125/EC
 - Ecodesign requirements for no load condition electric power consumption and average active efficiency of external power supplies (EU)2019/1782
 - External a.c.. d.c. and a.c.. a.c. power supplies. Determination of no-load power and average efficiency of active modes EN 50563:2011/A1:2013
 - Electrical and electronic household and office equipment. Measurement of low power consumption EN50564
- RoHS 2.1 / RoHS 3 Directive 2011/65/EU + Amendment (EU) 2015/863
 - EN 50581:2012 (RoHS Standard)
 - BS EN IEC 63000:2018, Technical documentation for the assessment of electrical and electronic products with respect to the restriction of hazardous substances

This declaration is valid for products with date code February 2020 and later. The power supply described above is considered as a component and operated in combination with an end use system. The purchaser of this power supply should conduct system level EMC/EMS testing to verify system level conformance.

The following manufacturer is responsible for this declaration:

GlobTek, Inc USA
186 Veterans Drive, Northvale, NJ USA 07647
(Company Name and Address)

Person responsible for making this declaration:

Hans Moritz, QA Manager
(Name, Surname)

This declaration of conformity is issued under the sole responsibility of the manufacturer

Northvale, NJ USA January 29th, 2020 *Hans Moritz*

(Place) Date On Behalf of GlobTek Inc. Signature

Appendix A



Supplier's Declaration of Conformity

This Declaration of Conformity is hereby issued according to Chapter 1, Subpart A, Part 2 of Title 47 of the Code of Federal Regulations by:

Advanced Realtime Tracking GmbH & Co. KG
Am Oeferl 6
82362 Weilheim i. OB
Germany

EQUIPMENT "SMARTTRACK3" complies with the applicable requirements of FCC Rule Part 15

RESPONSIBLE PARTY located in the United States:

Violette Engineering Corporation
6731 Whittier Avenue
McLean, VA 22101
info@violettecorp.com

The responsible party warrants that each unit of equipment marketed under this Declaration of Conformity will be identical to the unit tested and found acceptable with the standards and that the records maintained by the responsible party continue to reflect the equipment being produced under such Supplier's Declaration of Conformity continue to comply within the variation that can be expected due to quantity production and testing on a statistical basis.

Weilheim i. OB, 24.03.2021



Dr. A. Weiss (Managing Director)



Advanced Realtime Tracking GmbH & Co. KG Am Oeferl 6 82362 Weilheim i. OB Germany



TECHNICAL COMPLIANCE STATEMENT

This is to certify that the product listed in follows was (were) tested in the BTL EMC Laboratory to comply with below FCC official limits.

Equipment Gigabit PoE+ Injector
Model Name TPE-115GI
Brand Name Trendnet
Applicant Trendnet, Inc.
Address 20675 Manhattan Place, Torrance, CA90501, USA

Standard(s) FCC Part 15, Subpart B
 ANSI C63.4-2014

Report No BTL-FCCE-1-1711C014A

The test data, data evaluation, and equipment configuration contained in our test report(s) above was (were) obtained utilizing the test procedures, test instruments, test sites that has been accredited by the Authority of A2LA according to the ISO/IEC 17025 quality assessment standard and technical standard(s). The test data contained in the referenced test report relate only to the EUT sample and item(s) tested.

Kevin Li

Kevin Li

Authorized Signatory



BTL INC.

No. 3, Jinshagang 1st Road, Shixia, Dalang Town, Dongguan, Guangdong, China.

TEL:+86-769-8318-3000

FAX:+86-769-8319-6000



Certificate #5123.02



сертификат

Zertifikat

شهادة

Certificado

Certificate





EUROPEAN DECLARATION OF CONFORMITY STATEMENT

Advanced Realtime Tracking GmbH & Co. KG

declares under its sole responsibility that the product

SMARTTRACK3/M

to which this declaration relates is in conformity to the following standard(s) or other normative document(s)

2014/30/EC (EMC Directive): EN 55032:2015
EN 55035:2017

2011/65/EC (RoHS Directive): EN 63000:2018

Weilheim i. OB, 03.06.2022



Dr. A. Weiss (Managing Director)

Advanced Realtime Tracking GmbH & Co. KG Am Öferl 6 82362 Weilheim i. OB Germany





Supplier's Declaration of Conformity

This Declaration of Conformity is hereby issued according to Chapter 1, Subpart A, Part 2 of Title 47 of the Code of Federal Regulations by:

Advanced Realtime Tracking GmbH & Co. KG
Am Oeferl 6
82362 Weilheim i. OB
Germany

EQUIPMENT "SMARTTRACK3/M" complies with the applicable requirements of FCC Rule Part 15

RESPONSIBLE PARTY located in the United States:

Violette Engineering Corporation
6731 Whittier Avenue
McLean, VA 22101
info@violettecorp.com

The responsible party warrants that each unit of equipment marketed under this Declaration of Conformity will be identical to the unit tested and found acceptable with the standards and that the records maintained by the responsible party continue to reflect the equipment being produced under such Supplier's Declaration of Conformity continue to comply within the variation that can be expected due to quantity production and testing on a statistical basis.

Weilheim i. OB, 18.10.2021



Dr. A. Weiss (Managing Director)



Advanced Realtime Tracking GmbH & Co. KG Am Öferl 6 82362 Weilheim i. OB Germany





EUROPEAN DECLARATION OF CONFORMITY STATEMENT

Advanced Realtime Tracking GmbH & Co. KG

declares under its sole responsibility that the product

Flystick2+

to which this declaration relates is in conformity to the following standard(s) or other normative document(s)

2014/53/EC (RE Directive): ETSI EN 300 328 V2.2.2

2014/30/EC (EMC Directive): EN 55032:2015
EN 55035:2017

2011/65/EC (RoHS Directive): EN 63000:2018

Weilheim i. OB, 29.10.2021



Dr. A. Weiss (Managing Director)

Advanced Realtime Tracking GmbH & Co. KG Am Öferl 6 82362 Weilheim i. OB Germany





Supplier's Declaration of Conformity

This Declaration of Conformity is hereby issued according to Chapter 1, Subpart A, Part 2 of Title 47 of the Code of Federal Regulations by:

Advanced Realtime Tracking GmbH & Co. KG
Am Oeferl 6
82362 Weilheim i. OB
Germany

EQUIPMENT "Flystick2+" complies with the applicable requirements of FCC Rule Part 15

RESPONSIBLE PARTY located in the United States:

Violette Engineering Corporation
6731 Whittier Avenue
McLean, VA 22101
info@violettecorp.com

The responsible party warrants that each unit of equipment marketed under this Declaration of Conformity will be identical to the unit tested and found acceptable with the standards and that the records maintained by the responsible party continue to reflect the equipment being produced under such Supplier's Declaration of Conformity continue to comply within the variation that can be expected due to quantity production and testing on a statistical basis.

Weilheim i. OB, 29.10.2021



Dr. A. Weiss (Managing Director)



Advanced Realtime Tracking GmbH & Co. KG Am Öferl 6 82362 Weilheim i. OB Germany



ZERTIFIKAT ◆ CERTIFICATE ◆ 認證證書 ◆ CERTIFICADO ◆ CERTIFICAT



America

CERTIFICATE

No. U8 052228 0024 Rev. 00

Holder of Certificate: Advanced Realtime Tracking GmbH
Am Öferl 6
82362 Weilheim
GERMANY

Production Facility(ies): 052228

Certification Mark:



C US

Product: Information Technology Equipment
(IR-Tracking Camera)

Brand Name: ART

Model(s): AT6/M

Parameters: PoE powered

Tested according to: UL 62368-1:2014
CAN/CSA-C22.2 No. 62368-1:2014

This product was voluntarily tested to the relevant safety requirements referenced on this certificate. It can be marked with the certification mark above. The mark must not be altered in any way. This product certification system operated by TÜV SÜD America Inc. most closely resembles system 3 as defined in ISO/IEC 17067. Certification is based on the TÜV SÜD "Testing and Certification Regulations". TÜV SÜD America Inc. is an OSHA recognized NRTL and a Standards Council of Canada accredited Certification body.

Test report no.: 713198040

Date, 2020-11-20

(Abdul Sabbagh)

ZERTIFIKAT • CERTIFICATE • 認証証書 • CERTIFICADO • CERTIFICAT



America

CERTIFICATE

No. U8 15 08 52228 013

Holder of Certificate: Advanced Realtime Tracking GmbH

Am Öferl 6
82362 Weilheim
GERMANY

Production Facility(ies): 52228

Certification Mark:



C US

Product: Scanner
(IR-Tracking Camera)

Model(s): ARTTRACK5
ARTTRACK5/C
TRACKPACK/ E

Parameters:

ARTTRACK5	
ARTTRACK5/C	
Rated voltage:	57 V DC
Rated power:	17 W
Protection class:	III
TRACKPACK/ E	
Rated voltage:	57 V DC
Rated power:	5 W
Protection class:	III

Tested according to: UL 60950-1:2007/R:2014-10
CAN/CSA-C22.2 No. 60950-1:2007/A2:2014-10

The product was voluntarily tested according to the relevant safety requirements noted above. It can be marked with the certification mark above. The mark must not be altered in anyway. This product certification system operated by TÜV SÜD America Inc. most closely resembles system 3 as defined in ISO/IEC Guide 67. Certification is based on the TÜV SÜD "Testing and Certification Regulations". TÜV SÜD America Inc. is an OSHA recognized NRTL and a Standards Council of Canada accredited certification body.

Test report no.: 028-713035454-100

Date, 2015-08-06

Page 1 of 1



TÜV SÜD AMERICA INC. • 10 Centennial Drive • Peabody MA 01960 USA • www.TUVamerica.com

TÜV®

Appendix A

ZERTIFIKAT ◆ CERTIFICATE ◆ 認證證書 ◆ CERTIFICADO ◆ CERTIFICAT



America

CERTIFICATE

No. U8 052228 0022 Rev. 00

Holder of Certificate: **Advanced Realtime Tracking GmbH**

Am Öferl 6
82362 Weilheim
GERMANY

Production Facility(ies): 052228

Certification Mark:



C US

Product: **Computer**

Model(s): **Controller**

Parameters: Rated voltage: 100-240 VAC
Rated frequency: 50/60 Hz
Rated current: 4A
Protection class: I

Tested according to: UL 62368-1:2014
CAN/CSA-C22.2 No. 62368-1:2014

This product was voluntarily tested to the relevant safety requirements referenced on this certificate. It can be marked with the certification mark above. The mark must not be altered in any way. This product certification system operated by TÜV SÜD America Inc. most closely resembles system 3 as defined in ISO/IEC 17067. Certification is based on the TÜV SÜD "Testing and Certification Regulations". TÜV SÜD America Inc. is an OSHA recognized NRTL and a Standards Council of Canada accredited Certification body.

Test report no.: 028-713190948-000

Date, 2020-08-04

(Ralph Fischer)

ZERTIFIKAT ◆ CERTIFICATE ◆ 認證證書 ◆ CERTIFICADO ◆ CERTIFICAT



America

CERTIFICATE

No. U8 052228 0027 Rev. 00

Holder of Certificate: **Advanced Realtime Tracking GmbH & Co. KG**

Am Öferl 6
82362 Weilheim i. OB
GERMANY

Certification Mark:

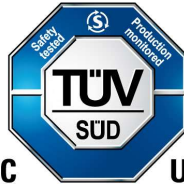

C US

Product: **Information Technology Equipment
(IR-Tracking Camera)**

Model(s): **SMARTTRACK3, SMARTTRACK3/M**

Parameters: SMARTTRACK3, SMARTTRACK3/M: PoE powered

External PoE power supply: Input 100-240Vac, 50-60Hz, 0.6A;
Output 56Vdc, 0.32A, 18W

Tested according to: UL 62368-1:2014
CAN/CSA-C22.2 No. 62368-1:2014

This product was voluntarily tested to the relevant safety requirements referenced on this certificate. It can be marked with the certification mark above. The mark must not be altered in any way. This product certification system operated by TÜV SÜD America Inc. most closely resembles system 3 as defined in ISO/IEC 17067. Certification is based on the TÜV SÜD "Testing and Certification Regulations". TÜV SÜD America Inc. is an OSHA recognized NRTL and a Standards Council of Canada accredited Certification body.

Test report no.: 713224494

Date, 2021-10-11

(Abdul Sabbagh)

Appendix A

сертификат

Zertifikat

شهادة

Certificado

Certificate



TECHNICAL COMPLIANCE STATEMENT

This is to certify that the product listed in follows was (were) tested in the BTL EMC Laboratory to comply with below FCC official limits.

Equipment Gigabit PoE+ Injector
Model Name TPE-115GI
Brand Name Trendnet
Applicant Trendnet,Inc.
Address 20675 Manhattan Place, Torrance, CA90501, USA

Standard(s) FCC Part 15, Subpart B
 ANSI C63.4-2014

Report No BTL-FCCE-1-1711C014A

The test data, data evaluation, and equipment configuration contained in our test report(s) above was (were) obtained utilizing the test procedures, test instruments, test sites that has been accredited by the Authority of A2LA according to the ISO/IEC 17025 quality assessment standard and technical standard(s). The test data contained in the referenced test report relate only to the EUT sample and item(s) tested.

Kevin Li

Kevin Li

Authorized Signatory

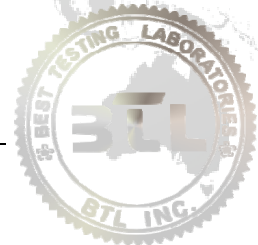

BTL INC.

No. 3, Jinshagang 1st Road, Shixia, Dalang Town,
 Dongguan, Guangdong, China.

TEL:+86-769-8318-3000

FAX:+86-769-8319-6000



Certificate #5123.02



ZERTIFIKAT ◆ CERTIFICATE ◆ 認證證書 ◆ CERTIFICADO ◆ CERTIFICAT



America

CERTIFICATE

No. U8 052228 0025 Rev. 00

Holder of Certificate: **Advanced Realtime Tracking GmbH & Co. KG**
 Am Öferl 6
 82362 Weilheim i. OB
 GERMANY

Certification Mark:

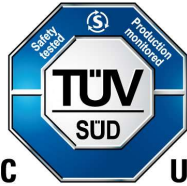

C US

Product: **Information Technology Equipment**

Brand Name: **ART**

Model(s): **Flystick2+**

Parameters: 2x 1.2 V NiMH AA batteries supplied.
 USB-C: 5 Vdc, 500 mA.

Tested according to: UL 62368-1:2014
 CAN/CSA-C22.2 No. 62368-1:2014

This product was voluntarily tested to the relevant safety requirements referenced on this certificate. It can be marked with the certification mark above. The mark must not be altered in any way. This product certification system operated by TÜV SÜD America Inc. most closely resembles system 3 as defined in ISO/IEC 17067. Certification is based on the TÜV SÜD "Testing and Certification Regulations". TÜV SÜD America Inc. is an OSHA recognized NRTL and a Standards Council of Canada accredited Certification body.

Test report no.: 713210723

Date, 2021-06-09

(Abdul Sabbagh)

A.9 Declaration of conformity (discontinued products)

ZERTIFIKAT • CERTIFICATE • 認証証書 • CERTIFICADO • CERTIFICAT

UCB / 10.10



CERTIFICATE

No. U8 17 02 52228 016

Holder of Certificate: Advanced Realtime Tracking GmbH

Am Öferl 6
82362 Weilheim
GERMANY

Production Facility(ies): 52228

Certification Mark:



Product: Computer

Model(s): Controller

Parameters:
Rated voltage: 100-240 VAC
Rated frequency: 50/60 Hz
Rated current: 4A
Protection class: I

Tested according to: UL 60950-1:2007/R:2014-10
CAN/CSA-C22.2 No. 60950-1:2007/A2:2014-10

The product was voluntarily tested according to the relevant safety requirements noted above. It can be marked with the certification mark above. The mark must not be altered in any way. This product certification system operated by TÜV SÜD America Inc. most closely resembles system 3 as defined in ISO/IEC 17067. Certification is based on the TÜV SÜD "Testing and Certification Regulations". TÜV SÜD America Inc. is an OSHA recognized NRTL and a Standards Council of Canada accredited certification body.

Test report no.: 028-713041124-100

Date, 2017-02-16

Page 1 of 1





**MANUFACTURER'S FEDERAL COMMUNICATION COMMISSION
DECLARATION OF CONFORMITY STATEMENT**

Advanced Realtime Tracking GmbH

declares under its sole responsibility that the product

ART Controller

to which this declaration relates is in conformity to the following standard:

**FCC 47 CFR Part 15, Subpart B
Class B digital device**

Operation is subject to the following two conditions:

- (1) this device may not cause harmful interference, and
- (2) this device must accept any interference received, including interference that may cause undesired operation.

Weilheim i. OB, 14.11.2014

A handwritten signature in blue ink, appearing to read 'A. Weiss', is written over a horizontal line. Below the line, the text 'Dr. A. Weiss (Managing Director)' is printed.

Advanced Realtime Tracking GmbH Am Öferl 6 82362 Weilheim i. OB Germany



EUROPEAN DECLARATION OF CONFORMITY STATEMENT

Advanced Realtime Tracking GmbH

declares under its sole responsibility that the product

SMARTTRACK

to which this declaration relates is in conformity to the following standard(s) or other normative document(s)

2014/35/EC (Low Voltage Directive):	EN 60950-1:2006 + A11:2009 + A1:2010 + A12:2011 + A2:2013
2014/30/EC (EMC Directive):	EN 55032:2015 + AC:2016 EN 55024:2010 + A1:2015 EN 61000-3-2:2014 EN 61000-3-3:2013
2011/65/EC (RoHS Directive):	EN 50581:2012

Weilheim i. OB, 16.01.2018



Dr. A. Weiss (Managing Director)

Advanced Realtime Tracking GmbH Am Öferl 6 82362 Weilheim i. OB Germany





**MANUFACTURER'S FEDERAL COMMUNICATION COMMISSION
DECLARATION OF CONFORMITY STATEMENT**

Advanced Realtime Tracking GmbH

declares under its sole responsibility that the product

SMARTTRACK

to which this declaration relates is in conformity to the following standard:

**FCC 47 CFR Part 15, Subpart B
Class B digital device**

Operation is subject to the following two conditions:

- (1) this device may not cause harmful interference, and
- (2) this device must accept any interference received, including interference that may cause undesired operation.

Weilheim i. OB, 08.09.2014

A handwritten signature in blue ink, appearing to read 'A. Weiss', is written over a horizontal line. Below the line, the text 'Dr. A. Weiss (Managing Director)' is printed.

Advanced Realtime Tracking GmbH Am Öferl 6 82362 Weilheim i. OB Germany

ZERTIFIKAT • CERTIFICATE • 認証証書 • CERTIFICADO • CERTIFICAT

UCB / 10.10



America

CERTIFICATE

No. U8 17 02 52228 014

Holder of Certificate: Advanced Realtime Tracking GmbH

Am Öferl 6
82362 Weilheim
GERMANY

Production Facility(ies): 52228

Certification Mark:



C US

Product: Scanner
(IR-Tracking Camera)

Model(s): SMARTTRACK

Parameters: SMARTTRACK

Rated voltage: 5 VDC
Rated power: max. 20 W
Protection class: III

Tested according to: UL 60950-1:2007/R:2014-10
CAN/CSA-C22.2 No. 60950-1:2007/A2:2014-10

The product was voluntarily tested according to the relevant safety requirements noted above. It can be marked with the certification mark above. The mark must not be altered in any way. This product certification system operated by TÜV SÜD America Inc. most closely resembles system 3 as defined in ISO/IEC 17067. Certification is based on the TÜV SÜD "Testing and Certification Regulations". TÜV SÜD America Inc. is an OSHA recognized NRTL and a Standards Council of Canada accredited certification body.

Test report no.: 028-713035476-100

Date, 2017-02-16

Page 1 of 1



TÜV SÜD AMERICA INC. • 10 Centennial Drive • Peabody MA 01960 USA • www.TUVamerica.com

TUV®



Product Service

CERTIFICATE

No. Z1A 14 04 52228 007

Holder of Certificate: **Advanced Realtime Tracking GmbH**
 Am Öferl 6
 82362 Weilheim
 GERMANY

Factory(ies): 52228

Certification Mark:



Product: **Scanner
 (IR-Tracking Camera)**

Model(s): **SMARTTRACK**

Parameters:

Rated voltage:	SMARTTRACK
Rated power:	5 VDC
Protection class:	max. 20 W
	III

Tested according to: EN 60950-1/A2:2013
 ZEK 01.4-08

The product meets the safety and health requirements of the German Product Safety Act section 20 to 22 ProdSG. The certification marks shown above can be affixed on the product. It is not permitted to alter the certification marks in any way. In addition the certificate holder must not transfer the certificate to third parties. This certificate is valid until the listed date, unless it is cancelled earlier. See also notes overleaf.

Test report no.: 028-713035476-000

Valid until: 2019-04-08

Date, 2014-04-11

(Ralph Fischer)

Page 1 of 1



Advanced Realtime Tracking GmbH
Am Oeferl 6, 82362 Weilheim i.OB, Germany

To whom it may concern

European Declaration of Conformity



Weilheim, 2013-05-28

Manufacturer:

Advanced Realtime Tracking GmbH
Am Oeferl 6
D – 82362 Weilheim i. OB
Germany

Directives:

We the manufacturer hereby confirm, that the products are in compliance with the general requirements of the following directives
- EMC-Directive 89/336/EEC
- Low Voltage Directive 73/23/EEC modified by 93/68/EEC

Products :

ARTTRACK2 (infrared optical tracking camera)
ARTTRACK3 (infrared optical tracking camera)
TRACKPACK (infrared optical tracking camera)
SMARTTRACK (integrated infrared tracking system)
Flystick2 (Flystick input device and receiver)
Flystick3 (Flystick input device, charging unit and receiver)
Fingertracking (Finger interaction device and chargers)
Controller with synccard and software DTrack2
Any related accessories (cables, Ethernet switch etc)

Standards compliance with:

DIN EN 60950-1
EN 61000 -2 / -3
EN 55103 -1 / -2
EN 55022

A.R.T. GmbH
Dr.-Ing. K. Zürl

Advanced Realtime Tracking GmbH
Am Oeferl 6
82362 Weilheim i.OB
Germany

T +49 (0) 881 - 92 530 - 04
F +49 (0) 881 - 92 530 - 01

www.ar-tracking.de

Managing Directors
Dr.-Ing. Konrad Zürl
Dr. Armin Weiß
Dr. Ralf Rabätje

Amtsgericht München
HRB 128 437
Tax-ID: 11912180990
VAT-no.: DE205356303

Kreissparkasse
München Starnberg Ebersberg
Bank account no. 520 66 77
Bank Code 702 501 50
IBAN DE40 7025 0150 0005 2066 77
SWIFT-BIC BYLADEM1KMS

ZERTIFIKAT ◆ CERTIFICATE ◆ 認証証書 ◆ CERTIFICADO ◆ CERTIFIKAT ◆ CERTIFICAT



Product Service

CERTIFICATE

No. U8 05 01 52228 001

Holder of Certificate: **Advanced Realtime Tracking GmbH**

Am Öferl 6
82362 Weilheim
GERMANY

Production Facility(ies): 52228

Certification Mark:

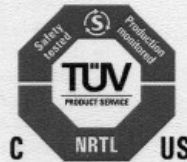

Product: **Scanners
(IR-Tracking Camera)**

Model(s): **ARTtrack 1
ARTtrack 2**

Parameters:	Rating voltage:	ARTtrack 1 100-240 VAC	ARTtrack2 12 VDC
	Rated frequency:	50/60 Hz	--
	Rating Current:	max. 230mA	max. 2A
	Protection class:	I	III

Tested according to: UL 60950-1:2003
CAN/CSA-C22.2 No. 60950-1:2003

The product was voluntarily tested according to the relevant safety requirements and mentioned properties. It can be marked with the certification mark shown above. See also notes overleaf.

Test report no.: 028-70086175-000

Date, 2005-01-27

Page 1 of 1



TÜV Product Service GmbH · TÜV SÜD Gruppe · Zertifizierstelle · Ridlerstrasse 65 · 80339 München · Germany

Appendix A

ZERTIFIKAT • CERTIFICATE • 認証証書 • CERTIFICADO • CERTIFICAT

UCE / 10.10



CERTIFICATE

No. U8 12 10 52228 006

Holder of Certificate: Advanced Realtime Tracking GmbH

Am Öferl 6
82362 Weilheim
GERMANY

Certification Mark:



Product: Scanner
(IR-Tracking Camera)

The product was voluntarily tested according to the relevant safety requirements noted above. It can be marked with the certification mark above. The mark must not be altered in anyway. This product certification system operated by TÜV SÜD America Inc. most closely resembles system 3 as defined in ISO/IEC Guide 67. Certification is based on the TÜV SÜD "Testing and Certification Regulations". TÜV SÜD America Inc. is an OSHA recognized NRTL and a Standards Council of Canada accredited certification body.

Test report no.: 028-71317852-200

Date, 2012-10-16

Page 1 of 2



TÜV SÜD AMERICA INC. • 10 Centennial Drive • Peabody MA 01960 USA • www.TUVamerica.com

TUV®



CERTIFICATE
No. U8 12 10 52228 006

Model(s): **ARTtrack 3**

Parameters:

Type:	ARTtrack 3
Rated voltage:	48Vdc
Rated power:	max. 25W
Weight:	1.5 kg
Protection class:	III
Options:	
Type:	Flystick2 Basisstation
Rated voltage:	24Vdc
Rated power:	max. 10W
Type:	Flystick2
Rated voltage:	3.6Vdc
Rated current:	33mA (supplied by battery pack)
Type:	Flystick3
Rated voltage:	5.0Vdc
Rated current:	150mA
Type:	Charging Unit
Rated voltage:	5.3Vdc
Rated current:	1.0A

Tested according to: UL 60950-1-07:2011
 CAN/CSA-C22.2 No. 60950-1A-07:2011

Production Facility(ies): 52228

Page 2 of 2



ZERTIFIKAT • CERTIFICATE • 認証証書 • CERTIFICADO • CERTIFICAT

UCB / 10.10



America

CERTIFICATE

No. U8 11 06 52228 005

Holder of Certificate: Advanced Realtime Tracking GmbH

Am Oferl 6
82362 Weilheim
GERMANY

Production Facility(ies): 52228

Certification Mark:

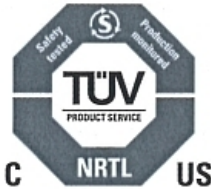

Product: Scanner
(IR-Tracking Camera)

Model(s): Trackpack
- ARTtrack/TP
- ARTtrack/TPC
- PC-ATC1

Parameters:
Rated voltage: 12 Vdc
Rated power: max 6W
Protection class: III

Tested according to: UL 60950-1:2007
CAN/CSA-C22.2 No. 60950-1:2007

The product was voluntarily tested according to the relevant safety requirements and mentioned properties. It can be marked with the certification mark shown above. The certification mark must not be altered in any way. This product certification system operated by TÜV SÜD America Inc. most closely resembles that described by ISO/IEC Guide 67, Conformity assessment - Fundamentals of product certification, System 3. See also notes overleaf.

Test report no.: 028-71338616-100

Date, 2011-06-27

Page 1 of 1



TÜV SÜD AMERICA INC. • 10 Centennial Drive • Peabody MA 01960 USA • www.TUVamerica.com

TUV®

List of Figures

2.1	WEEE label	18
3.1	Concept of optical tracking (stereo vision)	23
4.1	Camera ARTTRACK6/M - Description of LEDs and interface connectors	25
4.2	Camera ARTTRACK5 - Description of LEDs and interface connectors	26
4.3	Camera ARTTRACK5/C - Description of LEDs and interface connectors	27
4.4	Camera TRACKPACK/E - Description of LEDs and interface connectors	28
4.5	ART Controller	29
4.6	ART Controller/M	30
4.7	SMARTTRACK3 - Front & Back view	32
4.8	SMARTTRACK3/M - Front & Back view	32
4.9	View of PoE+ switches authorized by ART	33
4.10	USB Radio Transceiver3 - Description of LEDs	34
4.11	Camera ARTTRACK2 - Description of LEDs and interface connectors	35
4.12	Camera ARTTRACK3 - Description of LEDs and interface connectors	36
4.13	Camera TRACKPACK - Description of LEDs and interface connectors	37
4.14	Camera TRACKPACK/C - Description of LEDs and interface connectors	38
4.15	SMARTTRACK2 - Front & Back view	39
4.16	3D Visualization of the tracking volume	39
5.1	Typical situation arising from reflections through sunlight	41
5.2	Mutual blinding without reflex illustration	42
5.3	Origin of the room coordinate system (default)	44
5.4	A room calibration set consisting of angle and wand	45
5.5	Room calibration process	46
5.6	Attaching the T-Piece to the SMARTTRACK2/3/M	48
5.7	Mounting a camera to a wall or a ceiling (e.g. ARTTRACK2 camera)	48
5.8	Attaching the ceiling suspension to the ARTTRACK6/M camera	49
5.9	Attaching the ceiling suspension to the ARTTRACK5 camera	50
5.10	Camera ARTTRACK5/C remote head (back)	50
5.11	Attaching the Ceiling Suspension to the SMARTTRACK3	51
5.12	ART Controller front view	52
5.13	ART Controller back view	53
5.14	ART Controller/M front view	55
5.15	ART Controller/M back view	56
5.16	Connecting cameras to the ART Controller and ART Controller/M	59
5.17	SMARTTRACK3 - Front & Back view	61
5.18	SMARTTRACK3/M - Front & Back view	61
5.19	SMARTTRACK3 & PoE Injector Installation	63

List of Figures

5.20	Connecting a controller or SMARTTRACK2/3/M to a local network	64
5.21	Principle of cascading using the LAN	71
5.22	Principle of cascading master SMARTTRACK3 & SMARTTRACK3/M - slave SMARTTRACK3 & SMARTTRACK3/M	71
5.23	Principle of cascading using 'Cascaded Network Port'	72
5.24	Principle of cascading master ART Controller or ART Controller/M - slave SMARTTRACK3 & SMARTTRACK3/M	73
5.25	Principle of cascading using the internal camera network (discontinued)	74
5.26	Angular range of visibility	77
5.27	Flystick2+	83
5.28	Flystick2+ control elements	84
5.29	Flystick2+ - inserting the batteries	86
5.30	Charging the battery of the Flystick2+	87
5.31	Flystick2	88
5.32	Flystick2 control elements	89
5.33	Flystick2 - inserting the battery pack	90
5.34	Charging the battery of the Flystick2	91
5.35	FINGERTRACKING2 and FINGERTRACKING2 Tactile device (shown with three active finger markers)	93
5.36	FINGERTRACKING2 and FINGERTRACKING2 Tactile hand target	94
5.37	Inserting the battery (FINGERTRACKING2 and FINGERTRACKING2 Tactile)	95
5.38	Connecting the finger thimble connector with the hand target (FINGERTRACKING2 and FINGERTRACKING2 Tactile)	96
5.39	Comparison of the finger thimble sets (AR) for FINGERTRACKING2 (vibrational motor on FINGERTRACKING2 Tactile only)	96
5.40	Measurement Tool	99
5.41	Camera TRACKPACK/C with attached ceiling suspension	101
5.42	SMARTTRACK2 - Front & Back view	105
5.43	Flystick3	107
5.44	Flystick3 control elements	107
5.45	Open the battery compartment of Flystick3	109
5.46	Insert new battery in Flystick3	109
5.47	Close the battery compartment of Flystick3	110
5.48	All Fingertracking (discontinued) devices	112
5.49	Fingertracking hand target (discontinued)	112
5.50	Connecting the finger thimble set to the hand unit (Fingertracking)	114
5.51	Inserting the battery (Fingertracking discontinued)	114
5.52	Comparison of the finger thimble sets (VR, AR) for Fingertracking (discontinued)	115

List of Tables

1.1	Symbols and their meaning	12
4.1	Compatibility of DTRACK3 with ARTTRACK cameras, interaction devices and controllers	31
4.2	Compatible PoE+ switches authorized by ART	33
5.3	Standard targets overview	82
5.4	Description of the Flystick2+ Control Elements	84
5.5	Description of the Flystick2 Control Elements	89
5.6	Flystick2 battery charger status LEDs quick reference	92
5.7	Description of FINGERTRACKING2 and FINGERTRACKING2 Tactile hand target	94
5.8	Description of the finger thimbles FINGERTRACKING2 and FINGERTRACKING2 Tactile	97
5.9	Description of the LEDs on the back of the TRACKPACK Controller	105
5.10	Description of the Flystick3 control elements	108
5.11	Description of the hand target (Fingertracking discontinued)	113
5.12	Description of the configuration dial (Fingertracking discontinued)	113
5.13	Description of the finger thimbles Fingertracking (discontinued)	115

Index

- active stereo, 119, 124, 125
- camera orientation, 40
- Cascaded System, **66**
 - connecting, 67
 - starting, 69
- ceiling suspension D2, 49, 50
- coded flash, 78, 92, 111
- controller
 - ART Controller, 28
 - ART Controller/M, 29
- declaration of conformity, 143
- disclaimer, 3
- field of view (FoV), **137–139**
- flashless camera
 - ARTTRACK6/M for active markers, 26
- infrared camera
 - ARTTRACK2, 35
 - ARTTRACK3, 35
 - ARTTRACK5, 26
 - ARTTRACK5 /C, 27
 - ARTTRACK6/M, 25
 - TRACKPACK, 36
 - TRACKPACK/C, 37
 - TRACKPACK/E, 28
- infrared optical tracking system, 22
- installation
 - ART Controller, 52
 - ART Controller/M, 55
 - ARTTRACK Controller, 101
 - cables, 51
 - cameras, 58
 - LAN, 62
 - SMARTTRACK2, 104
 - SMARTTRACK3, 60
 - SMARTTRACK3/M, 60
 - TRACKPACK Controller, 103
- integrated systems
 - SMARTTRACK2, **38**
 - SMARTTRACK3, **31**
 - SMARTTRACK3M, **31**
- interaction device
 - Fingertracking (discontinued), **111**
 - Fingertracking finger thimble sets (discontinued), 115
 - Fingertracking hand targets (discontinued), 112
 - Fingertracking2, **92**
 - Fingertracking2 finger thimble sets, 96
 - Fingertracking2 hand targets, 93
 - Flystick2, **88**
 - Flystick2+, **83**
 - Flystick3, **106**
 - Measurement tool, **98**
- liability, 20
- maintenance, 17
- marker
 - active marker, 76
 - big active flat marker, 77
 - big active spherical marker, 77
 - passive marker, 75
- measurement volume, 45
- modulated flash, 92, 111
- mounting cameras, 46
 - tripod, 47
 - wall, 48
- open source declaration, 3
- PoE switches, **33**
- radio module, 87, 92, 95, 110
- Radio Transceiver, **34**
- reflections

- localizing & removing, 40
- mutual blinding, 41
- static reflex suppression, 43
- retro reflector, 76
- rigid body, 79
- room calibration, **43**
 - calibration angle, 40
 - hardware, 45
 - overview, **43**
 - process, 45
 - set, 45
 - virtual point cloud, 45
 - wand, 45
- safety, **12**
- synccard
 - Synccard2, **101**
 - Synccard3, **53**
 - Synccard3 in ART Controller /M, **56**
 - SynccardTP, **103**
- syncgroup, **10**, 53, 102
 - for TRACKPACK , 42
 - for ARTtrack, 123
- synchronization
 - active marker synchronization, 78
 - external synchronization, 65
 - wireless synchronization, 96, 115
- targets, 79
- terms and definitions, 9
- timestamp, 141
- tracking, introduction, 22
- trademarks, 2
- warnings, 12
- warranty, 20